



# 15

Stomach - Intestine  
Magen - Darm  
Estomago - Darm  
Estomago - Intestino  
Estomac - Intestin  
Stomaco - Intestino



Allis-Baby

CFS-15-200-13 13 cm - 5"

4 x 5

Teeth  
Zähne  
Dientes  
Dents  
Denti



Allis

CFS-15-201-15 CFS-15-202-15 15 cm - 6"

CFS-15-201-19 CFS-15-202-19 19 cm - 7 1/2"

CFS-15-201-25 CFS-15-202-25 25 cm - 9 3/4"

4 x 5 5 x 6

Teeth  
Zähne  
Dientes  
Dents  
Denti



Allis-Adair

CFS-16-203-15 15.5 cm - 6"

10 x 11

Teeth  
Zähne  
Dientes  
Dents  
Denti



Thomas-Allis

CFS-15-204-20 20 cm - 8"

7 x 6

Teeth  
Zähne  
Dientes  
Dents  
Denti



Lockwood

CFS-15-205-20 20 cm - 8"



Williams

CFS-15-206-16 16 cm - 6 1/4"



Tissue and Intestinal Holding Forceps

Gewebe - und Darmfazzangen  
 Pinza Spara tejidos y intestinos  
 Pincas intestinaleset de tissue  
 Tessuti e pinze di tenuta intesinali



Littlewood

CFS-15-207-19 19 cm - 7 1/2"

- 2 x 3
- Teeth
- Zähne
- Dientes
- Dents
- Denti



Boys-Allis

CFS-15-208-15 15 cm - 6"

- 5 x 6
- Teeth
- Zähne
- Dientes
- Dents
- Denti



Judd-Allis

CFS-15-209-15 15 cm - 6"

CFS-15-209-19 19 cm - 7 1/2"

- 3 x 4
- Teeth
- Zähne
- Dientes
- Dents
- Denti



Babcock

CFS-15-210-16T

16 cm - 6 1/4"



CFS-15-211-20T

20 cm - 8"

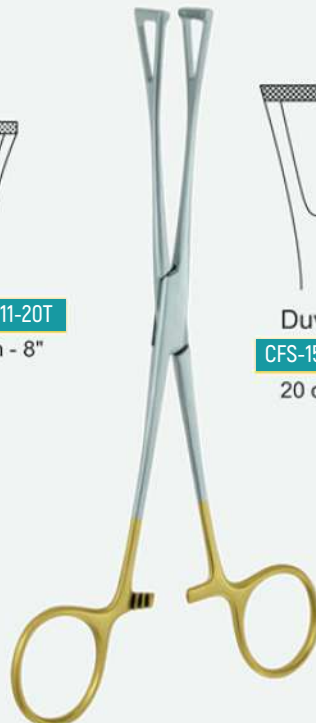

Duval

CFS-15-212-20T

20 cm - 8"



Babcock

CFS-15-213-16 16 cm - 6 1/4"

CFS-15-213-18 18 cm - 7"

CFS-15-213-20 20 cm - 8"

CFS-15-213-24 24 cm - 9 1/2"



Tissue and Intestinal Holding Forceps

Gewebe - und Darmfazzzangen  
 Pinza Spara tejidos y intestinos  
 Pincas intestinaleset de tissue  
 Tessuti e pinze di tenuta intestinali



Duval

CFS-15-214-18	CFS-15-215-18	18 cm - 7"
CFS-15-214-20	CFS-15-215-20	20 cm - 8"
CFS-15-214-23	CFS-15-215-23	23 cm - 9"



Babcock-Atrauma

CFS-16-216-16	CFS-16-217-20
16 cm - 6 1/4"	20 cm - 8"



Duval-Atrauma

CFS-15-218-23
23 cm - 9"



Allis-Atrauma

CFS-15-220-16	CFS-15-221-20	CFS-15-222-25
16 cm - 6 1/4"	20 cm - 8"	25 cm - 9 3/4"



Intestinal and Stomach Clamps

Darm - und Magenklammern

Pinzas - Clamps Para el Intestino y el estomago

Pinces - Clamps pour l' intestin et l' estomac

Morsetti Intestinali e di Stomaco

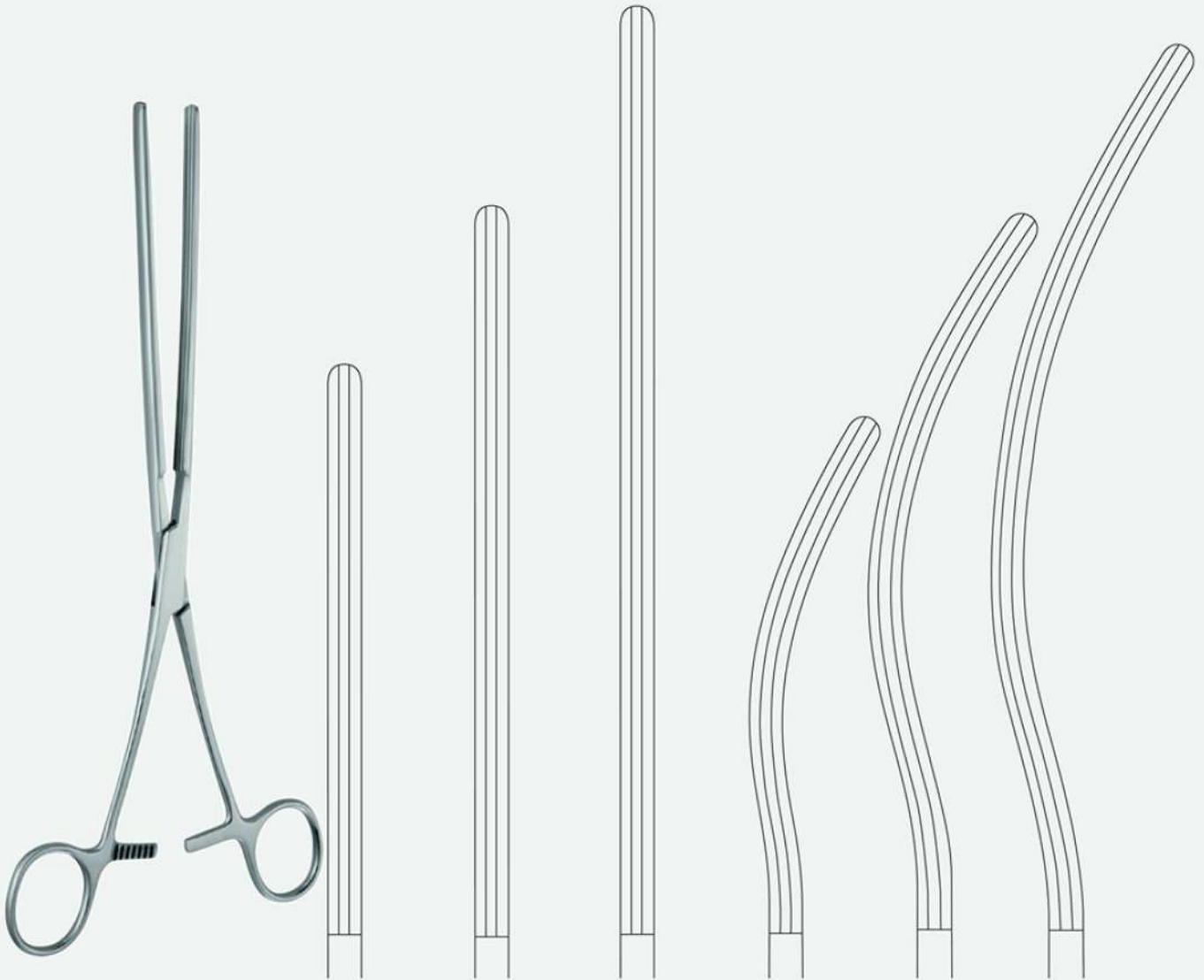

Kocher

CFS-15-223-22

22 cm - 8 3/4"

CFS-15-224-25

25 cm - 9 3/4"

CFS-15-225-28

28 cm - 11"

CFS-15-226-22

22 cm - 8 3/4"

CFS-15-227-25

25 cm - 9 3/4"

CFS-15-228-28

28 cm - 11"



Intestinal and Stomach Clamps

Darm - und Magenklappen

Pinzas - Clamps Para el Intestino y el estomago

Pinces - Clamps pour l' intestin et l' estomac

Morsetti Intestinali e di Stomaco



Allen  
**CFS-15-229-15** 15 cm - 6"  
 1 x 2  
 Intestinal clamp for children  
 Darmklemme für Kinder  
 Pinza intestinal para niños  
 Pince intestinal pour enfants  
 Pinza intestinale per bambini



Baby-Kocher  
**CFS-15-230-13** **CFS-15-231-13** 13 cm - 5"  
 Intestinal clamp for children, very elastic blades  
 Darmklemme für Kinder, sehr elastisch  
 Pinza intestinal para niños, muy elastica  
 Pince intestinal pour enfants, très élastique  
 Pinza intestinale per bambini, molto elastica



Baby-Doyen  
**CFS-15-232-18** **CFS-15-233-18** 18 cm - 7"



Doyen  
**CFS-15-234-21** **CFS-15-235-21** 21 cm - 8 ¼"  
**CFS-15-234-23** **CFS-15-235-23** 23 cm - 9"  
**CFS-15-234-28** **CFS-15-235-28** 28 cm - 11"

Intestinal and Stomach Clamps

Darm - und Magenklappen

Pinzas - Clamps Para el Intestino y el estomago

Pinces - Clamps pour l' intestin et l' estomac

Morsetti Intestinali e di Stomaco

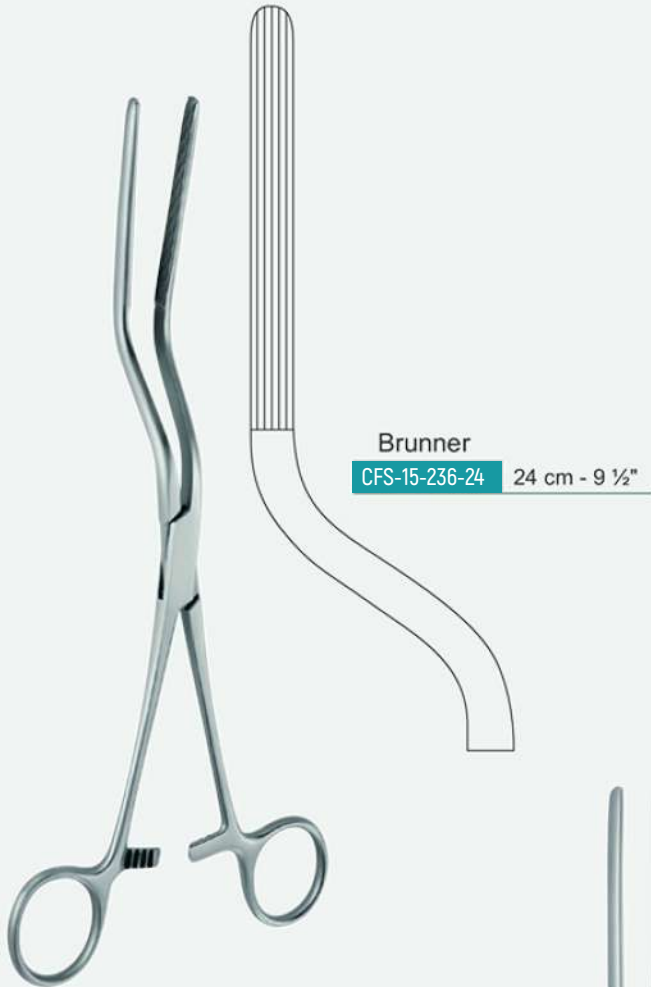

Brunner

CFS-15-236-24 24 cm - 9 ½"

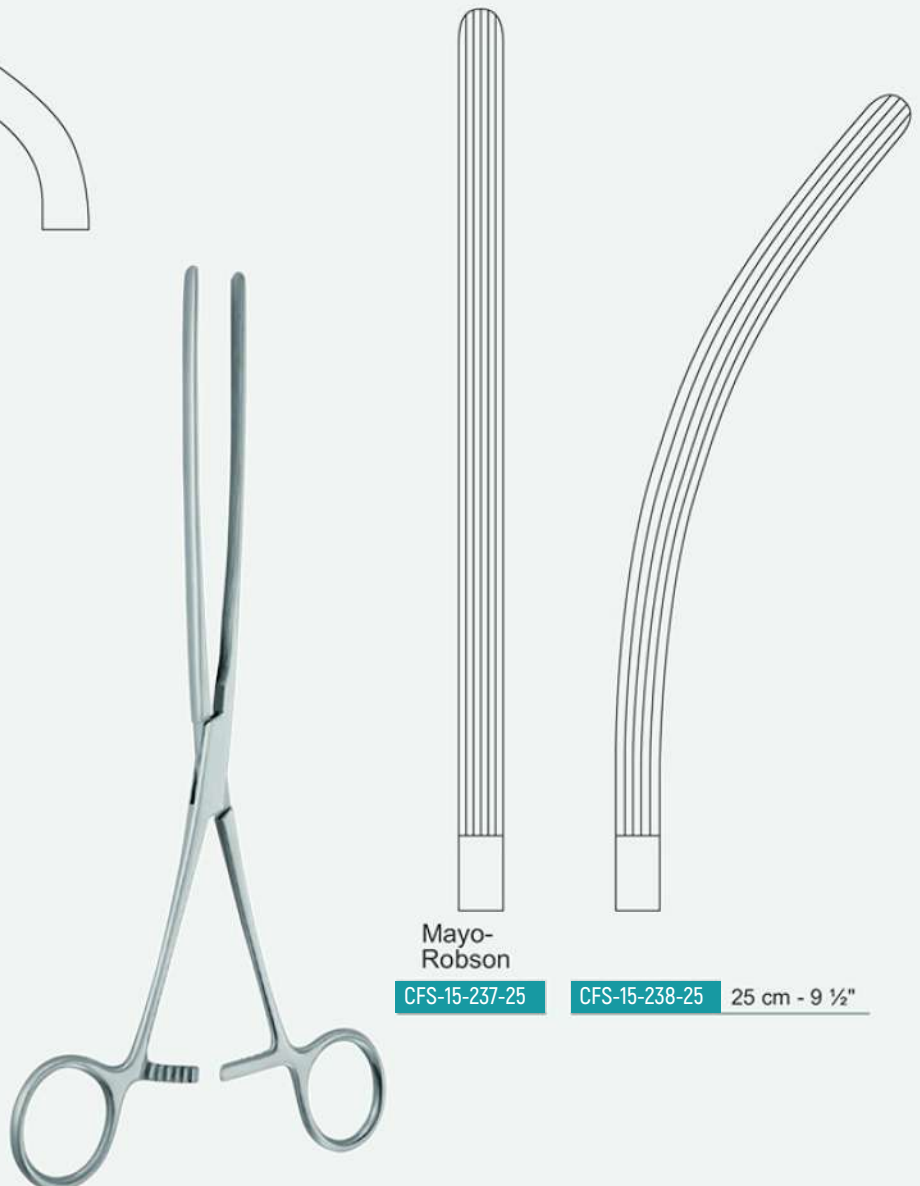

Mayo-  
Robson

CFS-15-237-25

CFS-15-238-25 25 cm - 9 ½"



Intestinal and Stomach Clamps

Darm - und Magenklammen

Pinzas - Clamps Para el Intestino y el estomago

Pinces - Clamps pour l' intestin et l' estomac

Morsetti Intestinali e di Stomaco



Lane

CFS-15-239-30

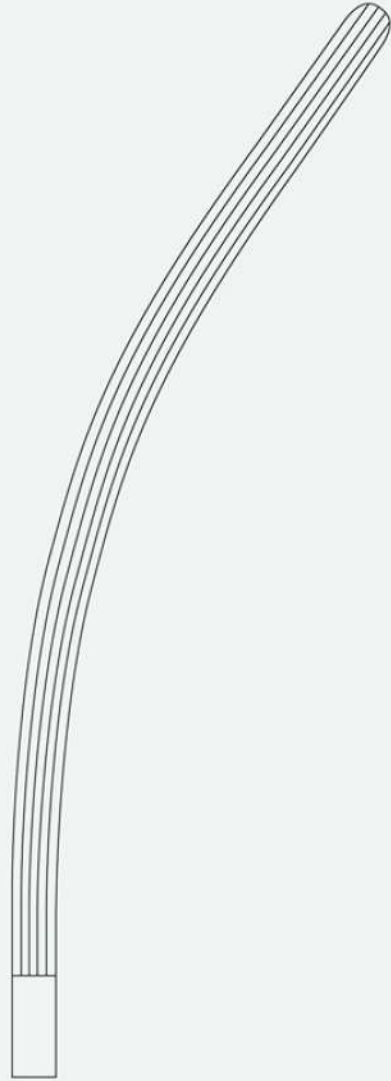

CFS-15-240-30

30 cm - 12"



Doyen

CFS-15-241-14  
14 cm - 5 1/2"

CFS-15-242-16  
16 cm - 6 1/4"

CFS-15-243-18  
18 cm - 7"

CFS-15-244-21  
21 cm - 8 1/4"

CFS-15-245-23  
23 cm - 9"

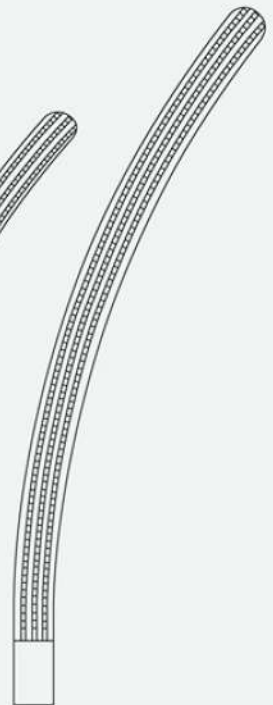
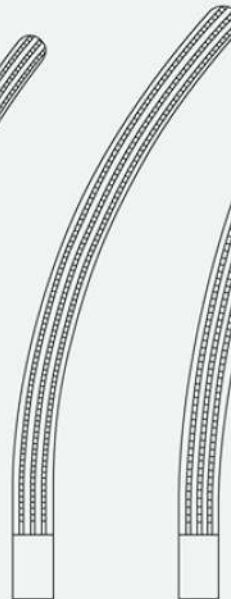
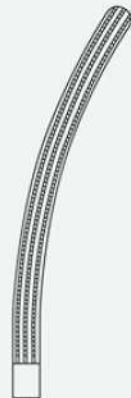

Doyen

CFS-15-246-14  
14 cm - 5 1/2"

CFS-15-247-16  
16 cm - 6 1/4"

CFS-15-248-18  
18 cm - 7"

CFS-15-249-21  
21 cm - 8 1/4"

CFS-15-250-23  
23 cm - 9"



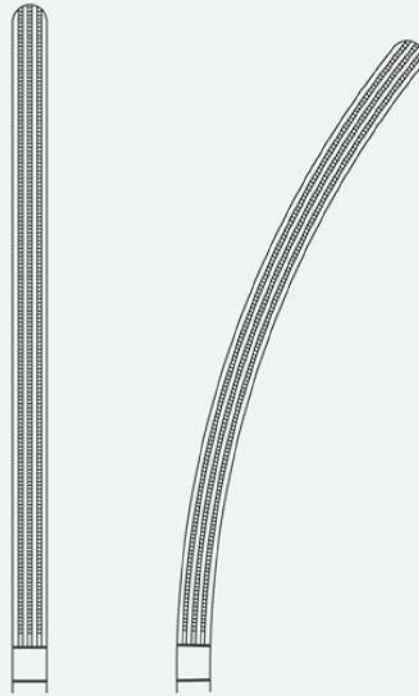

Mayo-Robson

CFS-16-251-25

CFS-16-252-25

25 cm - 9 3/4"

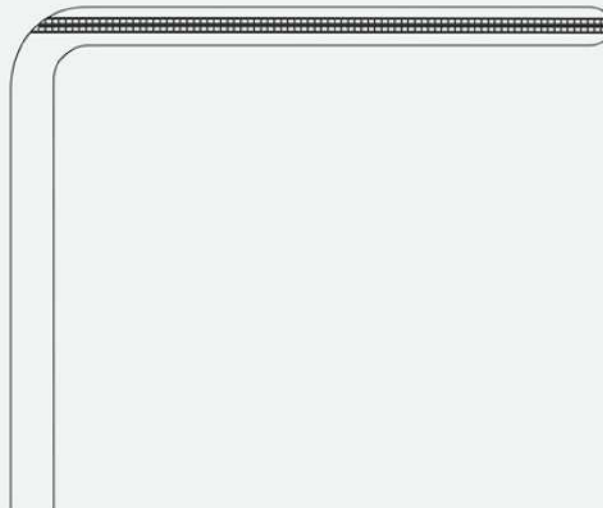

Resano

CFS-15-259-30

30 cm - 12"

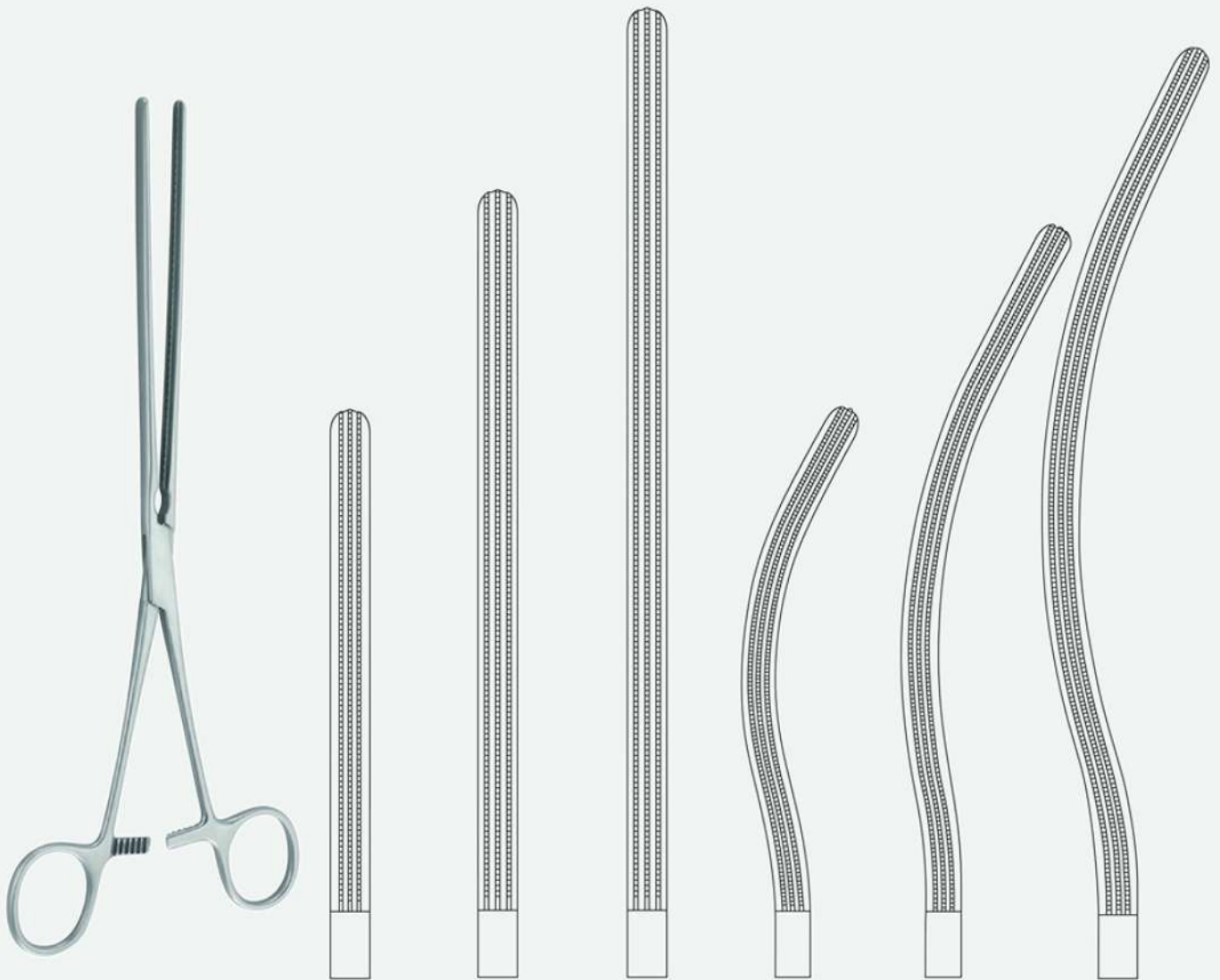

Kocher

CFS-15-253-22

22 cm - 8 3/4"

CFS-15-254-25

25 cm - 9 3/4"

CFS-15-255-28

28 cm - 11"

CFS-15-256-22

22 cm - 8 3/4"

CFS-15-257-25

25 cm - 9 3/4"

CFS-15-258-28

28 cm - 11"



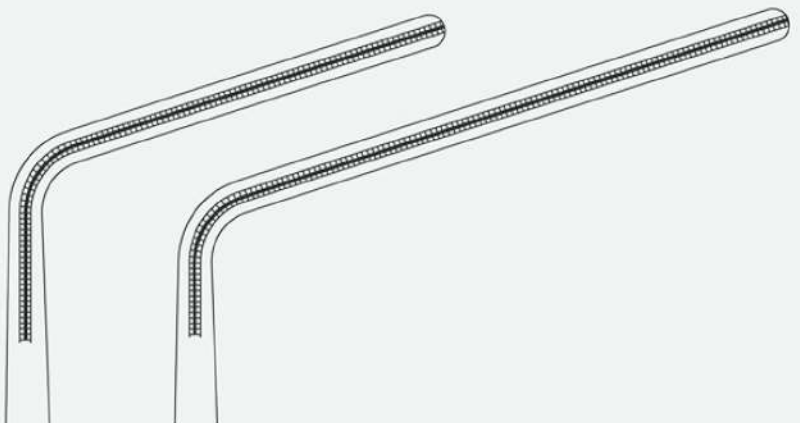

Hayes  
 CFS-15-260-26 26 cm - 10 ¼"  
 CFS-15-261-28 28 cm - 11"

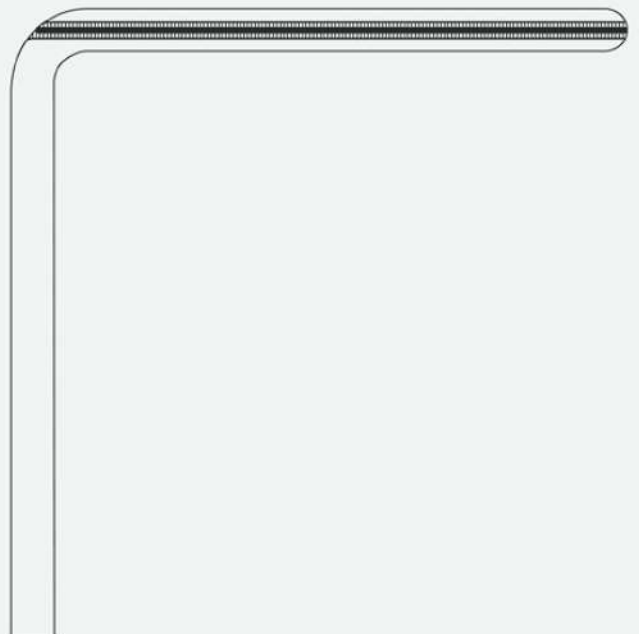

Fehland  
 CFS-15-262-24 24 cm - 10 ½"

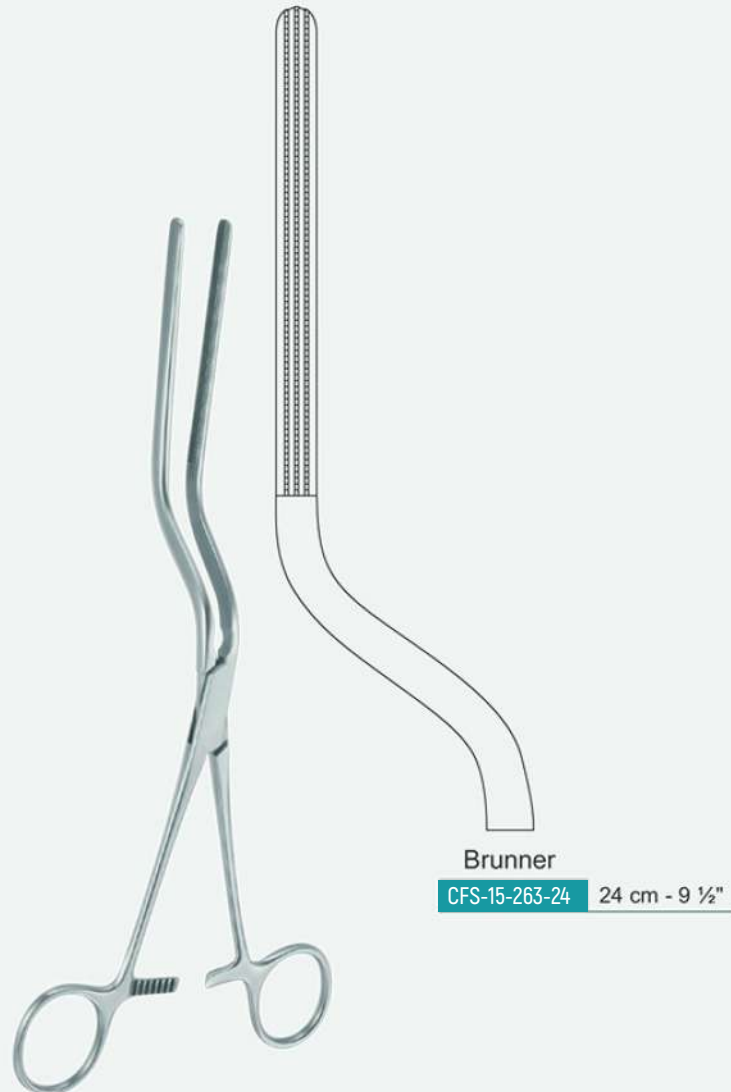



**Maxter**  
 Fig. 1

**CFS-15-264-25** 25 cm - 9 3/4"

Organfasszange mittel, 250 mm  
 Organ grasping forceps medium, 250 mm  
 Pince medium pour saisir des organes, 250 mm  
 Pinzamediano para sacar organos, 250 mm  
 Pinze per aerrare organi, 250 mm



Fig. 2

**CFS-15-265-26** 26 cm - 10 1/4"

Organ grasping forceps large, 260 mm  
 Organfasszange gross, 260 mm  
 Pinza grande para sacar organos, 260 mm  
 Pince grande pour saisir des organes, 260 mm  
 Pinze per aerrare organi, 260 mm



**Scheibe**

**CFS-15-266-18**

18 cm - 7"

narrow  
 schmal  
 estrecho  
 étroit  
 stretto

**CFS-15-267-20**

20 cm - 8"

medium  
 mittel  
 mediano  
 moyen  
 medio

**CFS-15-268-23**

23 cm - 9"

wide  
 breit  
 ancho  
 large  
 largo

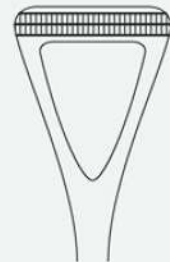



Payr-Baby

CFS-15-269-15 15 cm - 6"

with pin  
mit Stift  
con pivote  
avec cheville  
con perno



Payr

CFS-15-270-21

21 cm - 8 1/4"

with pin  
mit Stift  
con pivote  
avec cheville  
con perno

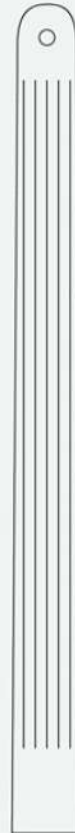

CFS-15-271-29

29 cm - 11 1/2"

9  
220  
210  
8  
200  
190  
7  
180  
170  
6  
160  
150  
5  
140  
130  
4  
120  
110  
3  
100  
90  
80  
2  
70  
60  
1  
50  
40  
30  
10  
MILLIMETERS  
INCHES



De Martel  
**CFS-15-272-08**  
 8.5 cm - 3 1/4"



De Martel-  
 Wolfson  
**CFS-15-273-73** 23 cm - 9"



De Martel-  
 Wolfson  
**CFS-15-274-26** 26 cm - 10 1/4"



De Martel-Wolfson

**CFS-15-275-05**  
 5 cm - 2"

**CFS-15-276-07**  
 7 cm - 2 3/4"

**CFS-15-277-10**  
 10 cm - 4"

Set of 3 clamps  
 Satz mit 3 Klemmen  
 Juego de 3 pinzas  
 Jeu de 3 clamps  
 Serie di 3 pezzi



Sims

CFS-15-278-00

x = 8 cm x 1.5 cm

CFS-15-279-00

x = 8 cm x 1.5 mm



Mathieu

CFS-15-280-19 19.5 cm - 7 3/4"

x = 90 mm



Pratt

CFS-15-281-20 20.5 cm - 8"

x = 8 cm x 2.5 cm



Pratt

CFS-15-282-22 22 cm - 8 3/4"

x = 11 cm x 2.5 cm





**Ives-Fansler**  
**CFS-15-283-09**  
 x = 9 cm



**Kelly**  
**CFS-15-284-01** 2.1 cm Ø  
**CFS-15-284-02** 2.7 cm Ø  
 x = 5 cm



**Bensaude**  
**CFS-15-285-01** 2 cm Ø  
**CFS-15-285-02** 2.3 cm Ø  
 18.5 cm - 7 ¼"  
 x = 5.5 cm





Hirschmann		
CFS-15-286-06	1.6 cm Ø	x = 6 cm
CFS-15-286-01	1.9 cm Ø	x = 7 cm
CFS-15-286-02	2.2 cm Ø	x = 9 cm

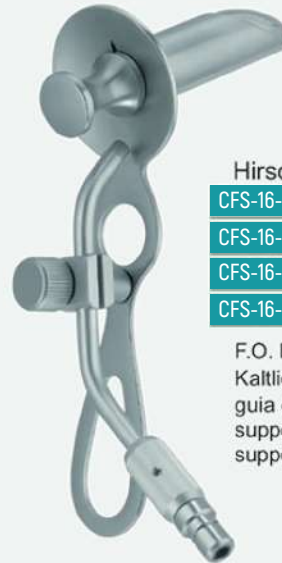

Hirschmann	
CFS-16-287-01	1.6 cm Ø
CFS-16-287-02	1.9 cm Ø
CFS-16-287-03	2.4 cm Ø
CFS-16-287-04	2.5 cm Ø

F.O. light carrier, Wolf  
 Kaltlichtaufsatz, Wolf  
 guia de luz fria, Wolf  
 support lumière froide, Wolf  
 supporto per luce fredda, Wolf

CFS-15-288-00

Cold light,  
 Kaltlichtadapter,  
 Adaptator luz fria,  
 Adapteur lum. froide,  
 Adattatore luce fredda,

Rectal specula  
 Analspreizer  
 Espéculos rectales  
 Spéculums pour le rectum  
 Divaricatore anale



Smith-Buie	
CFS-15-289-15	15 cm - 6"
x = 75 mm x 23 mm	
Max. spread 115 mm	
Max. Spreizweite 115 mm	
Apertura máxima 115 mm	
Écartement maximal 115 mm	
Apertura massima 115 mm	



Alan Parks

CFS-15-290-00

complete with 2 pair of blades and 1 center blade  
 komplett mit 2 Paar Valven und 1 Mittelvalve  
 completo con 2 juegos de valvas y 1 valva central  
 complet avec 2 paires des valves et 1 valve centrale  
 completo con 2 paia di valve e 1valva centrale



CFS-15-291-14 14 cm - 5 1/2"

complete with 2 pairs of blades and 1 center blade, with cold light connector Wolf  
 komplett mit 2 Paar Valven und 1 Mittelvalve, mit Kaltlichtanschluss Wolf  
 completo con 2 juegos de valvas y 1 valva central, con connector de luz fria Wolf  
 complet avec 2 paires des valves et 1 valve centrale, avec raccord de lum. froide Wolf  
 completo con 2 paia di valve e 1 valva centrale, con attacco di luce fredda Wolf

CFS-15-292-02 2.2 cm x 7.5 cm

Lateral blades only (pair)  
 Seitenvalven alleine (Paar)  
 Valvas laterales solas (par)  
 Valves latérales seules (paire)  
 Valve laterali solo (paio)

CFS-15-293-02

F.O. light carrier  
 Kaltlicht-Aufsatz  
 Soporte de luz fria  
 Support lumière froide  
 Supporto per luce fredda

CFS-15-294-02 2.2 cm x 9.5 cm

Lateral blades only (pair)  
 Seitenvalven alleine (Paar)  
 Valvas laterales solas (par)  
 Valves latérales seules (paire)  
 Valve laterali solo (paio)

CFS-15-295-02 2.5 cm x 9.5 cm

Central blade only  
 Mittelvalve alleine  
 Valva central sola  
 Valve centrale seule  
 Valva centrale solo



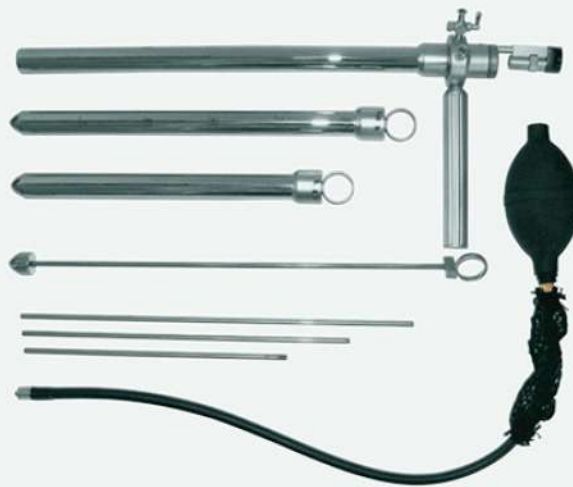

**Strauss**

**CFS-15-296-00**

Cold-light rectoscope, complete:

F/O Rectoscope-head with two-way stop cock, lens cover and telescope handle,  
 3 rectoscope-tubes 20mm Ø 200mm, 250mm and 300mm  
 with obturator and F/O light-carrier Wolf, with double blower, with cold light connection

Kaltlicht-Rektoskop, komplett:

F/O Rektoskopkopf mit Zweiwegehahn, Verschlussdeckel, Teleskop und Griff,  
 je 1 Rektoskoptubus in 200 mm, 250 mm und 300 mm mit 20 mm Ø,  
 mit Obturator und F/O Lichtträger Wolf-Anschluss, Doppelgebläse mit Kaltlichteinrichtung

Rectoscopio de luz fría, completo:

F/O cabeza de rectoscopio, con robinete protector de lentes, optica y mango,  
 3 tubos de rectoscopia de 20mm, Ø200mm, 250mm y 300mm de longitud,  
 con obturador y conector de luz fría Wolf y soplador.

Rectoscope à lumière froide, complet:

F/O tête de rectoscope avec robinet, protecteur de lentille, optique et manche,  
 3 tubes de rectoscope 20 mm Ø, 200 mm, 250 mm et 300 mm de longueur,  
 avec mandrin et porte-lumière Wolf (F/Q) souffleur et connecteur de lumière froide.

Luce fredda-Rettoscopio, completo

Testadi rettoscopio con fibre ottiche, con rubinetto a due vie, copri-lente e impugnatura per ottica,  
 3 tubi per rettoscopio 20 mm Ø, 200mm, 250mm e 300mm  
 con otturatore e cavo luce insufflatore a doppia palla e connettore per cavo luce, allacciamento Wolf.

**Strauss**

**CFS-15-297-00**

Cold light connector

Kaltlichtadapter

Raccord de lumière froide

Connector de luz fría

Attacco luce fredda



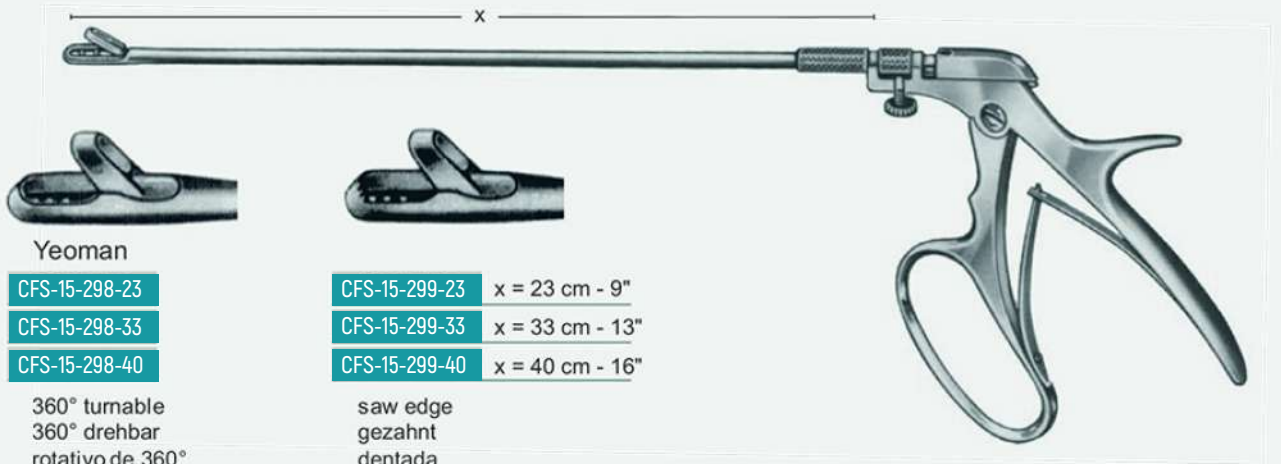

**Yeoman**

- CFS-15-298-23
- CFS-15-298-33
- CFS-15-298-40

360° turnable  
 360° drehbar  
 rotativo de 360°  
 rotative à 360°  
 rotativa di 360°

- CFS-15-299-23 x = 23 cm - 9"
- CFS-15-299-33 x = 33 cm - 13"
- CFS-15-299-40 x = 40 cm - 16"

saw edge  
 gezahnt  
 dentada  
 dentelé  
 dentata



**Turrel**

- CFS-15-300-23
- CFS-15-300-33
- CFS-15-300-40

360° turnable  
 360° drehbar  
 rotativo de 360°  
 rotative à 360°  
 rotativa di 360°



- CFS-15-301-23 x = 23 cm - 9"
- CFS-15-301-33 x = 33 cm - 13"
- CFS-15-301-40 x = 40 cm - 16"

saw edge  
 gezahnt  
 dentada  
 dentelé  
 dentata

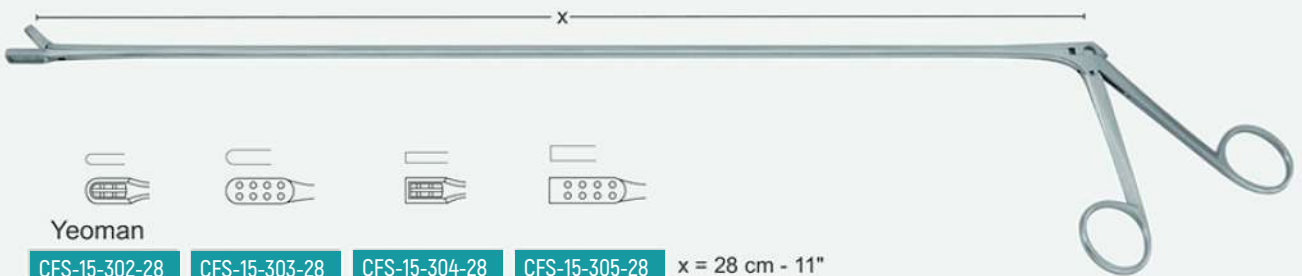

**Yeoman**

- |               |               |               |               |                   |
|---------------|---------------|---------------|---------------|-------------------|
| CFS-15-302-28 | CFS-15-303-28 | CFS-15-304-28 | CFS-15-305-28 | x = 28 cm - 11"   |
| CFS-15-302-35 | CFS-15-303-35 | CFS-15-304-35 | CFS-15-305-35 | x = 35 cm - 13 ¾" |
| CFS-15-302-42 | CFS-15-303-42 | CFS-15-304-42 | CFS-15-305-42 | x = 42 cm - 16 ½" |

Fig. 1

Fig. 2

Fig. 3

Fig. 4



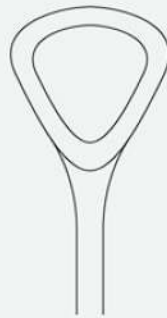

Luer

CFS-15-330-24 24.5 cm - 9 3/4"



Mc Givney

CFS-15-331-00

single curved  
 1x gebogen  
 curvadosimple  
 courbé simple  
 curvatura singola



CFS-15-332-19 19 cm - 7 1/2"

double curved  
 2x gebogen  
 curvado doble  
 courbé double  
 curvatura doppia



