

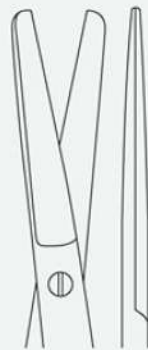

04

Scissors
Schere
Tijeras
Ciseaux
Forbici



Standard

- CFS-04-180-10
- CFS-04-180-11
- CFS-04-180-13
- CFS-04-180-14
- CFS-04-180-15
- CFS-04-180-16
- CFS-04-180-17
- CFS-04-180-18
- CFS-04-180-20



- CFS-04-181-10
- CFS-04-181-11
- CFS-04-181-13
- CFS-04-181-14
- CFS-04-181-15
- CFS-04-181-16
- CFS-04-181-17
- CFS-04-181-18
- CFS-04-181-20

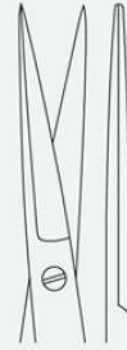

- CFS-04-182-10 10.5 cm - 4 ¼"
- CFS-04-182-11 11.5 cm - 4 ½"
- CFS-04-182-13 13 cm - 5"
- CFS-04-182-14 14.5 cm - 5 ¾"
- CFS-04-182-15 15 cm - 6"
- CFS-04-182-16 16.5 cm - 6 ½"
- CFS-04-182-17 17.5 cm - 7"
- CFS-04-182-18 18.5 cm - 7 ¼"
- CFS-04-182-20 20 cm - 8"

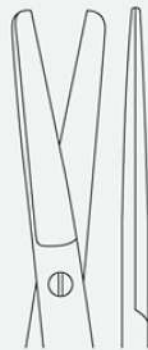

Standard

- CFS-04-183-14T
- CFS-04-183-16T
- CFS-04-186-14S
- CFS-04-186-13S

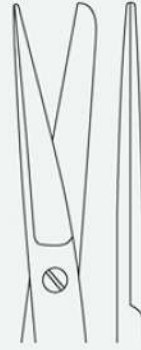

- CFS-04-184-14T
- CFS-04-184-16T
- CFS-04-187-14S
- CFS-04-187-13S

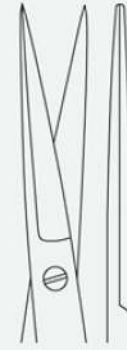

- CFS-04-185-14T 14.5 cm - 5 ¾"
- CFS-04-185-16T 16.5 cm - 6 ½"
- CFS-04-188-14S 14.5 cm - 5 ¾"
- CFS-04-188-13S 13 cm - 5"





Standard

CFS-04-189-11	CFS-04-190-11	CFS-04-191-11	11.5 cm - 4 ½"
CFS-04-189-13	CFS-04-190-13	CFS-04-191-13	13 cm - 5"
CFS-04-189-14	CFS-04-190-14	CFS-04-191-14	14.5 cm - 5 ¼"
CFS-04-189-15	CFS-04-190-15	CFS-04-191-15	15 cm - 6"
CFS-04-189-16	CFS-04-190-16	CFS-04-191-16	16.5 cm - 6 ½"
CFS-04-189-17	CFS-04-190-17	CFS-04-191-17	17.5 cm - 7"
CFS-04-189-18	CFS-04-190-18	CFS-04-191-18	18.5 cm - 7 ¼"
CFS-04-189-20	CFS-04-190-20	CFS-04-191-20	20 cm - 8"

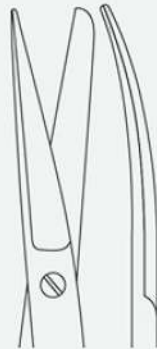
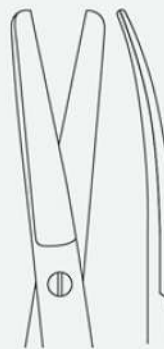

Standard

CFS-04-192-14T	CFS-04-193-14T	CFS-04-194-14T	14.5 cm - 5 ¾"
CFS-04-192-16T	CFS-04-193-16T	CFS-04-194-16T	16.5 cm - 6 ½"
CFS-04-195-14S	CFS-04-196-14S	CFS-04-194-16S	14.5 cm - 5 ¾"





Grazil

CFS-04-197-13	CFS-04-198-13	CFS-04-199-13	13 cm - 5"
CFS-04-197-14	CFS-04-198-14	CFS-04-199-14	14.5 cm - 5 ¾"
CFS-04-197-13T	CFS-04-198-13T	CFS-04-199-13T	14.5 cm - 5 ¾"
CFS-04-197-13S	CFS-04-198-13S	CFS-04-199-13S	14.5 cm - 5 ¾"



Grazil

CFS-04-200-13	CFS-04-201-13	CFS-04-202-13	13 cm - 5"
CFS-04-200-14	CFS-04-201-14	CFS-04-202-14	14.5 cm - 5 ¾"
CFS-04-200-14T	CFS-04-201-14T	CFS-04-202-14T	14.5 cm - 5 ¾"
CFS-04-200-14S	CFS-04-201-14S	CFS-04-202-14S	14.5 cm - 5 ¾"

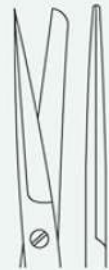

Deaver

CFS-04-203-14

straight
gerade
recta
droits

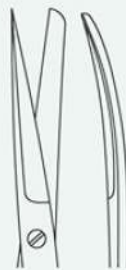

CFS-04-204-14

curved
gebogen
curva
courbes



CFS-04-205-14

straight, sawedge
gerade, gezahnt
recta, dentada
droits, dentelés



CFS-04-206-14

curved, sawedge
gebogen, gezahnt
curva, dentada
courbes, dentelés

14 cm - 5 1/2"

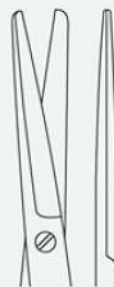

Mixer

CFS-04-207-15

straight
gerade
recta
droits



CFS-04-208-15

curved
gebogen
curva
courbes



CFS-04-209-15

straight, sawedge
gerade, gezahnt
recta, dentada
droits, dentelés



CFS-04-210-15

curved, sawedge
gebogen, gezahnt
curva, dentada
courbes, dentelés

15.5 cm - 6 1/8"



9
220
210
8
200
190
7
180
170
160
6
150
140
5
130
120
4
110
100
3
90
80
70
2
60
50
40
1
30
20
10
INCHES
MILLIMETERS

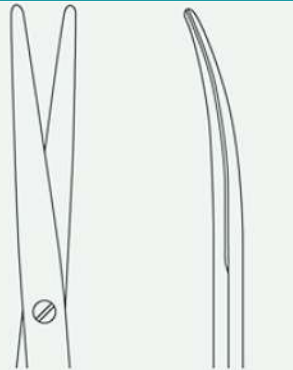

Lexer
CFS-04-211-16 **CFS-04-212-16**
 16 cm - 6 1/4" 16 cm - 6 1/4"
CFS-04-211-21 **CFS-04-212-21**
 21 cm - 8 1/4" 21 cm - 8 1/4"

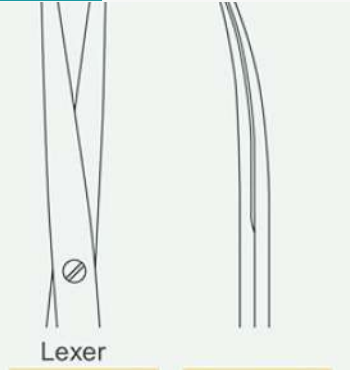

Lexer
CFS-04-213-16T **CFS-04-214-16T**
 16.5 cm - 6 1/2" 16.5 cm - 6 1/2"
CFS-04-213-21T **CFS-04-214-21T**
 21 cm - 8 1/4" 21 cm - 8 1/4"
CFS-04-215-16S **CFS-04-216-16S**
 16.5 cm - 6 1/2" 16.5 cm - 6 1/2"
CFS-04-215-21S **CFS-04-216-21S**
 21 cm - 8 1/4" 21 cm - 8 1/4"



Lexer-Baby
CFS-04-217-10 **CFS-04-218-10** **CFS-04-219-10** **CFS-04-220-10** 10 cm / 4"
 straight
gerade
recta
droits
 curved
gebogen
curva
courbes
 straight, saw edge
gerade, gezahnt
recta, dentada
droits, dentelés
 curved, saw edge
gebogen, gezahnt
curva, dentada
courbes, dentelés



Incision
CFS-04-221-13 **CFS-04-221-14** **CFS-04-221-16**
 13 cm - 5" 14.5 cm - 5 1/4" 16.5 cm - 6 1/2"



Incision - Modified
CFS-04-222-16
 16.5 cm - 6 1/2"

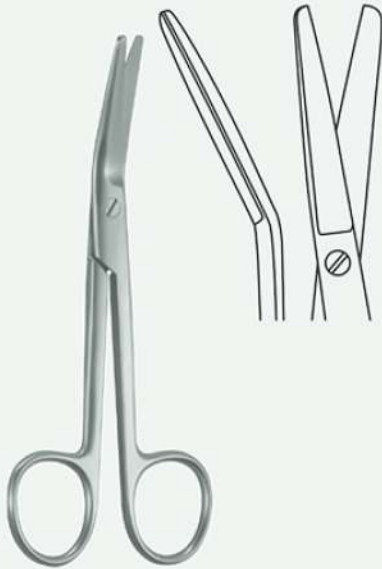

Fergusson

CFS-04-223-14

14 cm - 5 1/2"

CFS-04-223-16

16.5 cm - 6 1/2"

CFS-04-223-18

18 cm - 7"



Richter

CFS-04-224-14

14 cm - 5 1/2"



Lawson Tait

CFS-04-225-12

12.5 cm - 5"



Lange

CFS-04-226-14

straight
 gerade
 recta
 droits



CFS-04-227-14

curved
 gebogen
 curva
 courbes



CFS-04-228-14

straight, saw edge
 gerade, gezahnt
 recta, dentada
 droits, dentelés



CFS-04-229-14

curved, saw edge
 gebogen, gezahnt
 curva, dentada
 courbes, dentelés

14.5 cm - 5 3/4"

Mayo

CFS-04-230-14	CFS-04-231-14	14 cm - 5 1/2"
CFS-04-230-15	CFS-04-231-15	15 cm - 6"
CFS-04-230-17	CFS-04-231-17	17 cm - 6 3/4"
CFS-04-230-20	CFS-04-231-20	20 cm - 8"
CFS-04-230-23	CFS-04-231-23	23 cm - 9"
CFS-04-230-28	CFS-04-231-28	28 cm - 11"

Mayo-Stille

CFS-04-232-15	CFS-04-233-15	CFS-04-233-15B	15 cm - 6"
CFS-04-232-17	CFS-04-233-17	CFS-04-233-17B	17 cm - 6 3/4"
CFS-04-232-19	CFS-04-233-19	CFS-04-233-19B	19 cm - 7 1/2"
CFS-04-232-21	CFS-04-233-21	CFS-04-233-21B	21 cm - 8 1/4"
CFS-04-232-23	CFS-04-233-23	CFS-04-233-23B	23 cm - 9"

Mayo

CFS-04-234-14T	CFS-04-235-14T	14 cm - 5 1/2"	14 cm - 5 1/2"
CFS-04-234-17T	CFS-04-235-17T	17 cm - 6 3/4"	17 cm - 6 3/4"
CFS-04-234-23T	CFS-04-235-23T	23 cm - 9"	23 cm - 9"
CFS-04-236-14S	CFS-04-237-14S	14 cm - 5 1/2"	14 cm - 5 1/2"
CFS-04-236-17S	CFS-04-237-17S	17 cm - 6 3/4"	17 cm - 6 3/4"
CFS-04-236-23S	CFS-04-237-23S	23 cm - 9"	23 cm - 9"
CFS-04-236-25S	CFS-04-237-25S	25 cm - 10"	25 cm - 10"

Mayo-Stille

CFS-04-238-15T	CFS-04-239-15T	15 cm - 6"	15 cm - 6"		
CFS-04-238-17T	CFS-04-239-17T	17 cm - 6 3/4"	17 cm - 6 3/4"	CFS-04-240-17T	17 cm - 6 3/4"
CFS-04-241-15S	CFS-04-242-15S	15 cm - 6"	15 cm - 6"		
CFS-04-241-17S	CFS-04-242-17S	17 cm - 6 3/4"	17 cm - 6 3/4"		



Mayo-Lexer

CFS-04-243-16T

16.5 cm - 6 1/2"

CFS-04-245-16S

16.5 cm - 6 1/2"



CFS-04-244-16T

16.5 cm - 6 1/2"

CFS-04-246-16S

16.5 cm - 6 1/2"

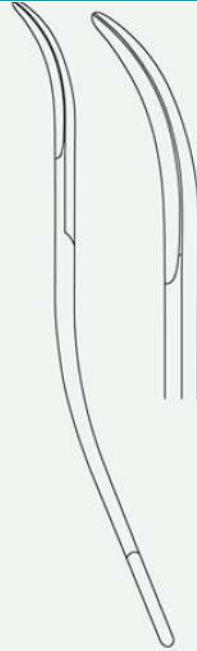

Mayo

CFS-04-247-18S

18 cm - 7"

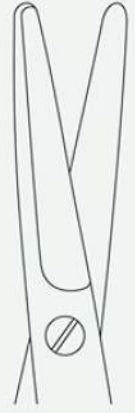

CFS-04-248-23S

23 cm - 9"



Mayo-Harrington

CFS-04-249-20

20 cm - 8"

CFS-04-249-23

23 cm - 9"

CFS-04-249-20T

20 cm - 8"

CFS-04-249-23T

23 cm - 9"

CFS-04-249-30S

30 cm - 12"



CFS-04-250-20

20 cm - 8"

CFS-04-250-23

23 cm - 9"

CFS-04-250-20T

20 cm - 8"

CFS-04-250-23T

23 cm - 9"

CFS-04-250-30S

30 cm - 12"



Mayo-Noble

CFS-04-351-17

17 cm - 6 3/4"



CFS-04-352-17

17 cm - 6 3/4"



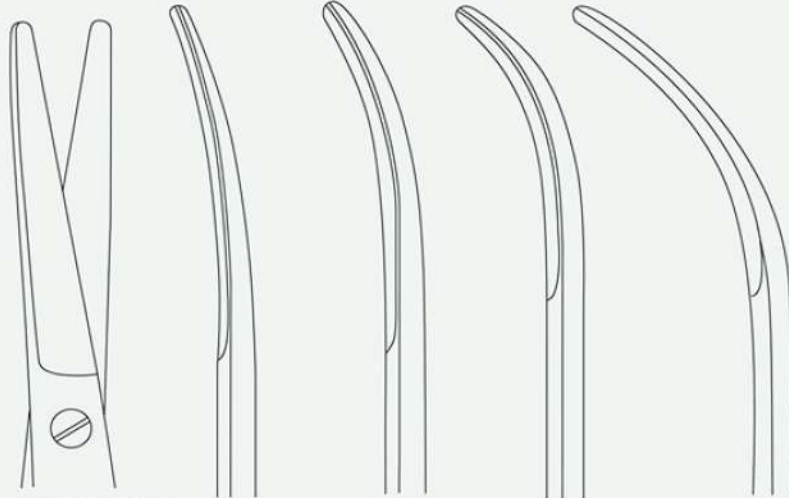

Parametrium

CFS-04-249-23

CFS-04-250-23

CFS-04-251-23

CFS-04-252-23

CFS-04-253-23

23 cm - 9"

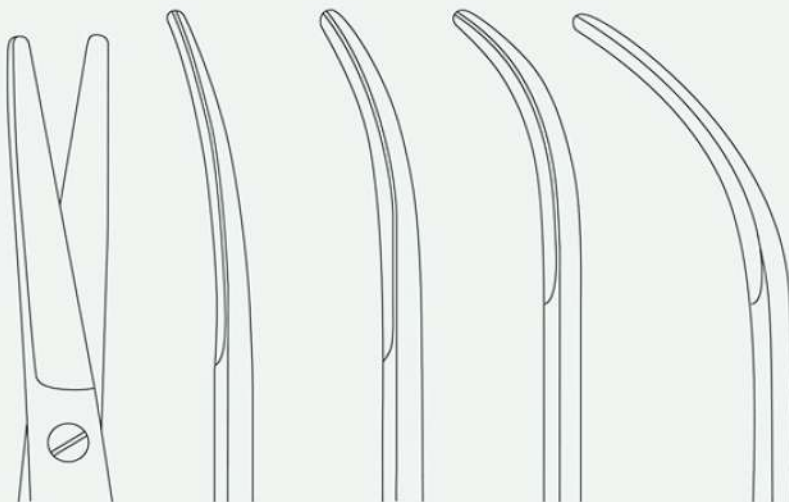
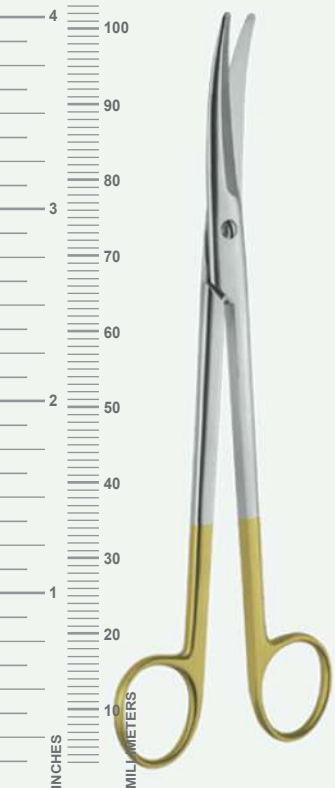

Parametrium

CFS-04-254-23T

CFS-04-255-23T

CFS-04-256-23T

CFS-04-257-23T

CFS-04-258-23T

23 cm - 9"

CFS-04-254-27T

CFS-04-255-27T

CFS-04-256-27T

CFS-04-257-27T

CFS-04-258-27T

28 cm - 11"

CFS-04-254-32T

CFS-04-255-32T

CFS-04-256-32T

CFS-04-257-32T

CFS-04-258-32T

32 cm - 12"



Metzenbaum

- CFS-04-259-14
14.5 cm - 5 3/4"
- CFS-04-259-15
15 cm - 6"
- CFS-04-259-18
18 cm - 7"
- CFS-04-259-20
20 cm - 8"
- CFS-04-259-23
23 cm - 9"
- CFS-04-259-25
25 cm - 10"
- CFS-04-259-28
28 cm - 11"
- CFS-04-259-30
30 cm - 12"



CFS-04-260-14
14.5 cm - 5 3/4"



CFS-04-261-14
14.5 cm - 5 3/4"
CFS-04-261-18
18 cm - 7"



CFS-04-262-14
14.5 cm - 5 3/4"
CFS-04-262-18
18 cm - 7"
CFS-04-262-20
20 cm - 8"
CFS-04-262-23
23 cm - 9"

fine
fein
multa
amende



Metzenbaum

- CFS-04-263-14
14.5 cm - 5 3/4"
- CFS-04-263-15
15 cm - 5 3/4"
- CFS-04-263-18
18 cm - 7"
- CFS-04-263-20
20 cm - 8"
- CFS-04-263-23
23 cm - 9"
- CFS-04-263-25
25 cm - 10"
- CFS-04-263-28
28 cm - 11"
- CFS-04-263-30
30 cm - 12"



CFS-04-264-14
14.5 cm - 5 3/4"



CFS-04-265-14
14.5 cm - 5 3/4"
CFS-04-265-18
18 cm - 7"
CFS-04-265-20
20 cm - 8"



CFS-04-266-14
14.5 cm - 5 3/4"
CFS-04-266-18
18 cm - 7"
CFS-04-266-20
20 cm - 8"
CFS-04-266-23
23 cm - 9"

fine
fein
multa
amende





Metzenbaum

- CFS-04-266-11T** **CFS-04-267-23T**
11.5 cm - 4 1/2" 23 cm - 9"
- CFS-04-266-14T** **CFS-04-267-25T**
14.5 cm - 5 3/4" 25 cm - 10"
- CFS-04-266-18T** **CFS-04-267-28T**
18 cm - 7" 28 cm - 11"
- CFS-04-266-20T** **CFS-04-267-30T**
20 cm - 8" 30 cm - 12"
- CFS-04-268-11S** **CFS-04-269-18S**
11.5 cm - 4 1/2" 18 cm - 7"
- CFS-04-268-14S** **CFS-04-269-20S**
14.5 cm - 5 3/4" 20 cm - 8"
- CFS-04-268-16S**
16 cm - 6 1/4"



- CFS-04-270-14T**
14.5 cm / 5 3/4"



- CFS-04-271-14T**
14.5 cm / 5 3/4"



- CFS-04-272-14T** **CFS-04-273-14S**
14.5 cm - 5 3/4" 14.5 cm - 5 3/4"
- CFS-04-272-18T** **CFS-04-273-17S**
18 cm - 7" 17 cm - 6 3/4"
- CFS-04-272-20T** **CFS-04-273-28S**
20 cm - 8" 18 cm - 7"
- CFS-04-272-23T**
23 cm - 9"
- CFS-04-272-25T**
25 cm - 10"
- CFS-04-272-28T**
28 cm - 11"

fine
 fein
 multa
 amende



- CFS-04-274-14T**
14.5 cm / 5 3/4"
- CFS-04-274-18T**
18 cm - 7"
- CFS-04-274-23T**
23 cm - 9"

fine
 fein
 multa
 amende



Metzenbaum

CFS-04-275-11T	CFS-04-275-33T
11.5 cm - 4 1/2"	33 cm - 13"
CFS-04-275-14T	CFS-04-275-36T
14.5 cm - 5 3/4"	36 cm - 14 1/2"
CFS-04-275-18T	CFS-04-275-38T
18 cm - 7"	38 cm - 15"
CFS-04-275-20T	CFS-04-276-23S
20 cm - 8"	23 cm - 9"
CFS-04-275-23T	CFS-04-276-25S
23 cm - 9"	25 cm - 10"
CFS-04-275-25T	CFS-04-276-28S
25 cm - 10"	28 cm - 11"
CFS-04-275-28T	CFS-04-276-30S
28 cm - 11"	30 cm - 12"
CFS-04-275-30T	CFS-04-276-36S
30 cm - 12"	36 cm - 14 1/2"

CFS-04-277-14T
 14.5 cm - 5 3/4"

CFS-04-278-14T
 14.5 cm - 5 3/4"



CFS-04-280-14S	CFS-04-279-14T
14.5 cm - 5 3/4"	14.5 cm - 5 3/4"
CFS-04-280-17S	CFS-04-279-18T
17 cm - 6 3/4"	18 cm - 7"
CFS-04-280-18S	CFS-04-279-20T
18 cm - 7"	20 cm - 8"
	CFS-04-279-23T
	23 cm - 9"
	CFS-04-279-25T
	25 cm - 10"
	CFS-04-279-28T
	28 cm - 11"
	fine fein multa amende

CFS-04-281-14T
14.5 cm - 5 3/4"
CFS-04-281-18T
18 cm - 7"
CFS-04-281-23T
23 cm - 9"
CFS-04-281-28T
28 cm - 11"
CFS-04-281-33T
33 cm - 13"
CFS-04-281-36T
36 cm - 14 1/2"
fine fein multa amende

CFS-04-282-14T
14 cm - 5 1/2"
CFS-04-282-18T
18 cm - 7"
CFS-04-282-20T
20 cm - 8"
CFS-04-282-23T
23 cm - 9"
CFS-04-282-25T
25 cm - 10"
standard, serrated Standard gezackten dentada estándar dentelé norme

CFS-04-283-14T
14.5 cm - 5 3/4"
CFS-04-283-18T
18 cm - 7"
fine serrated fein gezackten multa dentada amende dentelé

CFS-04-284-20T
20 cm - 8"
CFS-04-284-23T
23 cm - 9"
CFS-04-284-28T
28 cm - 11"
strong curved stark gebogen muy curvado fortement incurvée



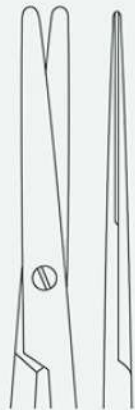

Nelson

- CFS-04-284-18
- CFS-04-284-20
- CFS-04-284-23
- CFS-04-284-26
- CFS-04-284-28
- CFS-04-284-30



- CFS-04-285-18
- CFS-04-285-20
- CFS-04-285-23
- CFS-04-285-26
- CFS-04-285-28
- CFS-04-285-30



- CFS-04-286-18 18 cm - 7"
- CFS-04-286-20 20 cm - 8"
- CFS-04-286-23 23 cm - 9"
- CFS-04-286-26 26 cm - 10 1/4"
- CFS-04-286-28 28 cm - 11"
- CFS-04-286-30 30 cm - 12"



Nelson

- CFS-04-284-18A
- CFS-04-284-20A
- CFS-04-284-23A
- CFS-04-284-26A
- CFS-04-284-28A
- CFS-04-284-30A



- CFS-04-284-17B
- CFS-04-284-20B
- CFS-04-284-23B
- CFS-04-284-26B
- CFS-04-284-28B
- CFS-04-284-30B



- CFS-04-284-17C 18 cm - 7"
- CFS-04-284-20C 20 cm - 8"
- CFS-04-284-23C 23 cm - 9"
- CFS-04-284-26C 26 cm - 10 1/4"
- CFS-04-284-28C 28 cm - 11"
- CFS-04-284-30C 30 cm - 12"



Nelson

- CFS-04-286-18T
- CFS-04-286-20T
- CFS-04-286-23T
- CFS-04-286-26T
- CFS-04-286-28T
- CFS-04-286-30T
- CFS-04-289-23S
- CFS-04-289-26S
- CFS-04-289-30S



- CFS-04-287-18T
- CFS-04-287-20T
- CFS-04-287-23T
- CFS-04-287-26T
- CFS-04-287-28T
- CFS-04-287-30T
- CFS-04-287-23S
- CFS-04-287-26S
- CFS-04-287-30S



- CFS-04-288-18T 18 cm - 7"
- CFS-04-288-20T 20 cm - 8"
- CFS-04-288-23T 23 cm - 9"
- CFS-04-288-26T 26 cm - 10 ¼"
- CFS-04-288-28T 28 cm - 11"
- CFS-04-288-30T 30 cm - 12"
- CFS-04-288-23S 23 cm - 9"
- CFS-04-288-26S 26 cm - 10 ¼"
- CFS-04-288-30S 30 cm - 11 ¾"



Nelson

- CFS-04-290-18T
- CFS-04-290-20T
- CFS-04-290-23T
- CFS-04-290-26T
- CFS-04-290-28T
- CFS-04-290-30T
- CFS-04-293-23S
- CFS-04-293-26S
- CFS-04-293-30S



- CFS-04-291-18T
- CFS-04-291-20T
- CFS-04-291-23T
- CFS-04-291-26T
- CFS-04-291-28T
- CFS-04-291-30T
- CFS-04-291-23S
- CFS-04-291-26S
- CFS-04-291-30S



- CFS-04-292-18T 18 cm - 7"
- CFS-04-292-20T 20 cm - 8"
- CFS-04-292-23T 23 cm - 9"
- CFS-04-292-26T 26 cm - 10 ¼"
- CFS-04-292-28T 28 cm - 11"
- CFS-04-292-30T 30 cm - 12"
- CFS-04-292-23S 23 cm - 9"
- CFS-04-292-26S 26 cm - 10 ¼"
- CFS-04-292-30S 30 cm - 11 ¾"



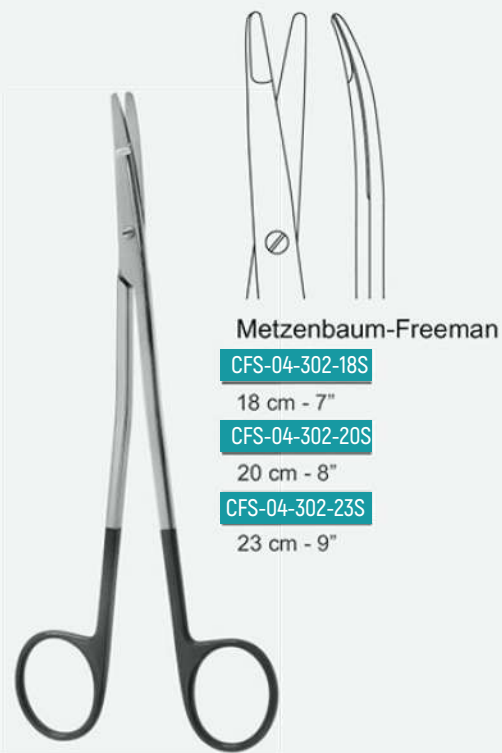
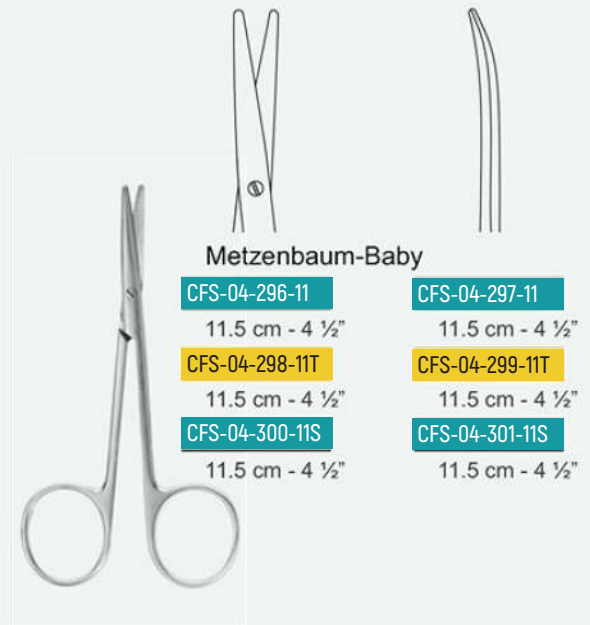
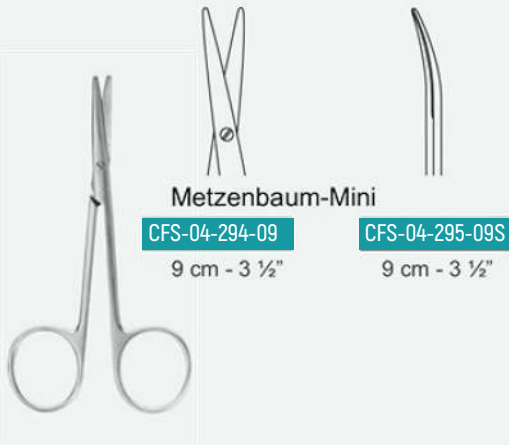



Metzenbaum-Fino

CFS-04-325-14

CFS-04-325-18

CFS-04-325-22

CFS-04-325-23

CFS-04-326-14

CFS-04-326-18

CFS-04-326-22

CFS-04-326-23

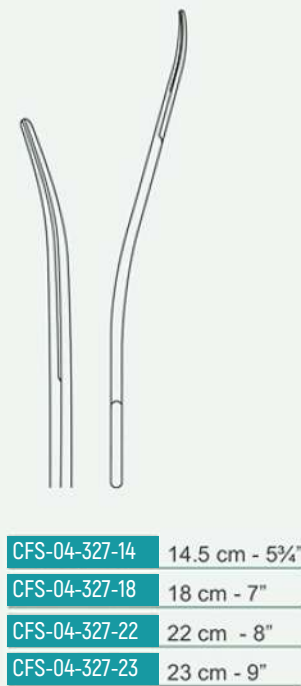

CFS-04-327-14

14.5 cm - 5 3/4"

CFS-04-327-18

18 cm - 7"

CFS-04-327-22

22 cm - 8"

CFS-04-327-23

23 cm - 9"

S-curved
 S-förmig gebogen
 curva en S
 courbes en S



Metzenbaum-Lahey

CFS-04-304-14T

14.5 cm - 5 3/4"



Metzenbaum - Fino

CFS-04-328-14T

CFS-04-329-14T

14.5 cm - 5 3/4"

CFS-04-328-18T

CFS-04-329-18T

18 cm - 7"

CFS-04-328-20T

CFS-04-329-20T

20 cm - 8"

CFS-04-328-23T

CFS-04-329-23T

23 cm - 9"



Metzenbaum - Fino

CFS-04-330-18T

CFS-04-331-18T

18 cm - 7"

CFS-04-330-20T

CFS-04-331-20T

20 cm - 8"

CFS-04-330-23T

CFS-04-331-23T

23 cm - 9"

S-curved
 S-förmig gebogen
 curva en S
 courbes en S





Fomon
CFS-04-332-12
 12.5 cm - 5"
CFS-04-333-12S
 12.5 cm - 5"

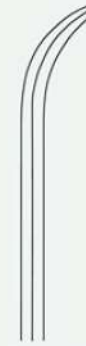

Thorek
CFS-04-334-19
 19 cm - 7 1/2"
CFS-04-334-25S
 25 cm - 10"



Sweet
CFS-04-335-21
 21.6 cm - 8 1/2"

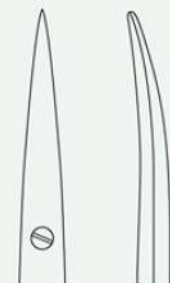

Dixon
CFS-04-159-15 Fig. 1
CFS-04-160-15 Fig. 2
 15 cm / 6"

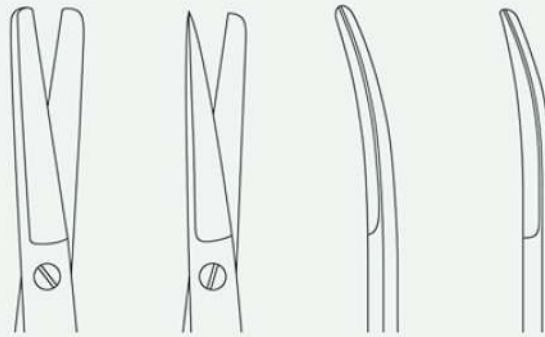

Sims

CFS-04-337-20	CFS-04-338-20	CFS-04-339-20	CFS-04-340-20	20 cm - 8"
CFS-04-337-23	CFS-04-338-23	CFS-04-339-23	CFS-04-340-23	23 cm - 9"
CFS-04-341-20T	CFS-04-342-20T	CFS-04-343-20T	CFS-04-344-20T	20 cm - 8"
CFS-04-341-23T	CFS-04-342-23T	CFS-04-343-23T	CFS-04-344-23T	23 cm - 9"
CFS-04-345-20S	CFS-04-346-20S	CFS-04-347-20S	CFS-04-348-20S	20 cm - 8"
CFS-04-2345-23S	CFS-04-2346-23S	CFS-04-2347-23S	CFS-04-2348-23S	23 cm - 9"

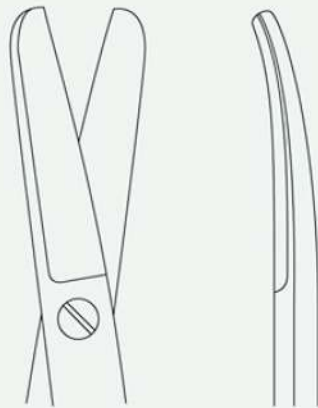

Dubois

CFS-04-349-27	CFS-04-350-27
27 cm / 10 3/4"	27 cm / 10 3/4"

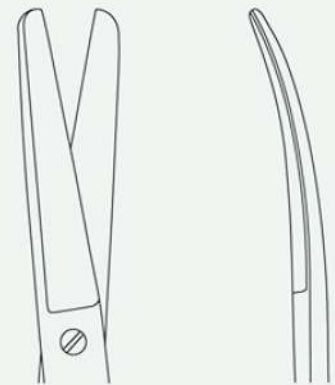

Doyen

CFS-04-351-16	CFS-04-352-16
16 cm - 6 1/4"	16 cm - 6 1/4"
CFS-04-351-18	CFS-04-352-18
18 cm - 7 1/8"	18 cm - 7 1/8"
CFS-04-351-18T	CFS-04-352-18T
18 cm - 7 1/8"	18 cm - 7 1/8"



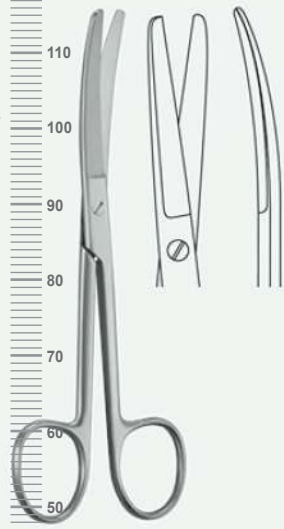

Wertheim

- | | |
|--|--|
| CFS-04-305-14
14.5 cm - 5 3/4" | CFS-04-304-14
14.5 cm - 5 3/4" |
| CFS-04-305-20
20 cm - 8" | CFS-04-304-20
20 cm - 8" |
| CFS-04-305-23
23 cm - 9" | CFS-04-304-23
23 cm - 9" |

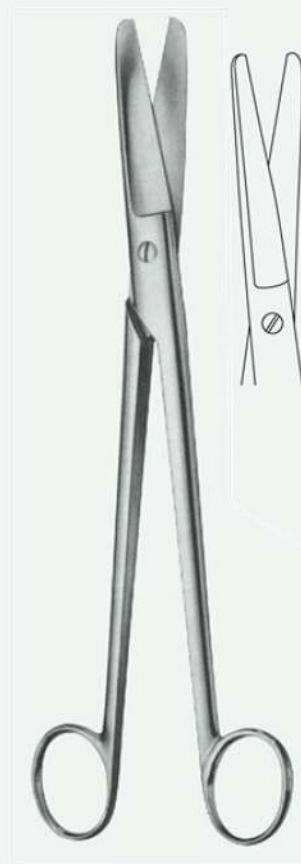

Sims-Siebold

- CFS-04-355-25**
25 cm - 10"

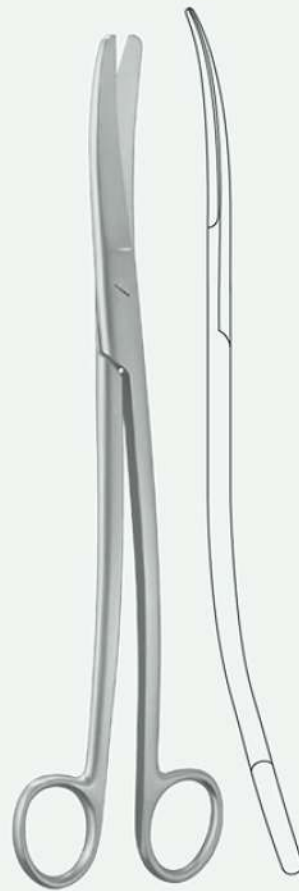

Siebold







- CFS-04-356-24**
24 cm - 9 1/2"
- S-curved
 S-förmig gebogen
 curva en S
 courbes en S









Bozemann

- CFS-04-357-22**
22 cm - 8 3/4"
- S-curved
 S-förmig gebogen
 curva en S
 courbes en S



						
Wagner	CFS-04-358-12	CFS-04-359-12	CFS-04-360-12	CFS-04-361-12	CFS-04-362-12	CFS-04-363-12 12 cm - 4 3/4"
gerade straight droits recta rette	gerade straight droits recta rette	gerade straight droits recta rette	gerade, gezahnt straight, saw edge droits, dentelés recta, dentada rette, dentate	gerade, gezahnt straight, saw edge droits, dentelés recta, dentada rette, dentate	gerade, gezahnt straight, saw edge droits, dentelés recta, dentada rette, dentate	gerade, gezahnt straight, saw edge droits, dentelés recta, dentada rette, dentate

					
CFS-04-364-12	CFS-04-365-12	CFS-04-366-12	CFS-04-367-12	CFS-04-368-12	CFS-04-369-12 12 cm - 4 3/4"
gebogen curved courbes curva curve	gebogen curved courbes curva curve	gebogen curved courbes curva curve	gebogen, gezahnt curved, saw edge courbes, dentelés curva, dentada curve, dentate	gebogen, gezahnt curved, saw edge courbes, dentelés curva, dentada curve, dentate	gebogen, gezahnt curved, saw edge courbes, dentelés curva, dentada curve, dentate



CFS-04-370-10
 10.5 cm - 4 1/8"





Standard - Fino

CFS-04-371-12	CFS-04-372-12	CFS-04-373-12	CFS-04-374-12	CFS-04-375-12	CFS-04-376-12	12 cm - 4 3/4"
---------------	---------------	---------------	---------------	---------------	---------------	----------------



Brophy (Sullivan)

CFS-04-377-14	CFS-04-378-14
14.5 cm - 5 3/4"	14.5 cm - 5 3/4"



Littler

CFS-04-379-12	12 cm / 4 3/4"
CFS-04-379-14	14.5 cm / 5 3/4"



Beuse

CFS-04-380-14	CFS-04-381-18	CFS-04-382-14	CFS-04-383-18
14 cm / 5 1/2"	18 cm / 7 1/8"	14 cm / 5 1/2"	18 cm / 7 1/8"



Locklin
CFS-04-384-16
 16 cm - 6 1/4"
 straight, saw edge
 gerade, gezahnt
 recta, dentada
 droits, dentelés

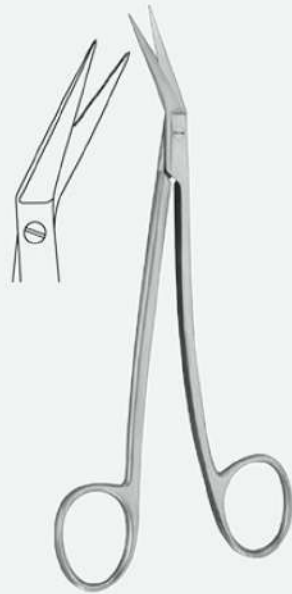

CFS-04-385-16
 16 cm - 6 1/4"
 curved
 gebogen
 curva
 courbes



Locklin
CFS-04-386-16T
 16 cm - 6 1/4"
 straight, saw edge
 gerade, gezahnt
 recta, dentada
 droits, dentelés



CFS-04-387-16T
 16 cm - 6 1/4"
 curved, saw edge
 gebogen, gezahnt
 curva, dentada
 courbes, dentelés



Reynolds
CFS-04-388-12 **CFS-04-389-14T**
 12 cm - 4 3/4" 14 cm - 5 1/2"
CFS-04-388-14 **CFS-04-390-12S**
 14 cm - 5 1/2" 12 cm - 4 3/4"
CFS-04-388-16 **CFS-04-390-16S**
 16 cm - 6 1/4" 16 cm - 6 1/4"
CFS-04-388-18 **CFS-04-390-18S**
 18 cm - 7" 18 cm - 7"



Reynolds
CFS-04-391-12 **CFS-04-392-14T**
 12 cm - 4 3/4" 14 cm - 5 1/2"
CFS-04-391-14 **CFS-04-393-12S**
 14 cm - 5 1/2" 12 cm - 4 3/4"
CFS-04-391-16 **CFS-04-393-16S**
 16 cm - 6 1/4" 16 cm - 6 1/4"
CFS-04-391-18 **CFS-04-393-18S**
 18 cm - 7" 18 cm - 7"



Jameson
CFS-04-394-15 **CFS-04-396-14S**
 15 cm - 6" 14 cm - 5 1/2"
CFS-04-394-18 **CFS-04-396-18S**
 18 cm - 7 1/8" 18 cm - 7 1/8"
CFS-04-395-14T **CFS-04-396-25S**
 14 cm - 5 1/2" 25 cm - 9 3/4"
CFS-04-396-28S
 28 cm - 11"



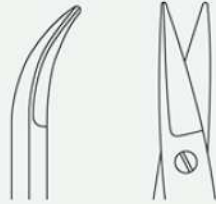

Quinby

CFS-04-397-12

12.5 cm - 6"

CFS-04-398-12

12.5 cm - 6"



Niro

CFS-04-399-14

14 cm - 5 1/2"

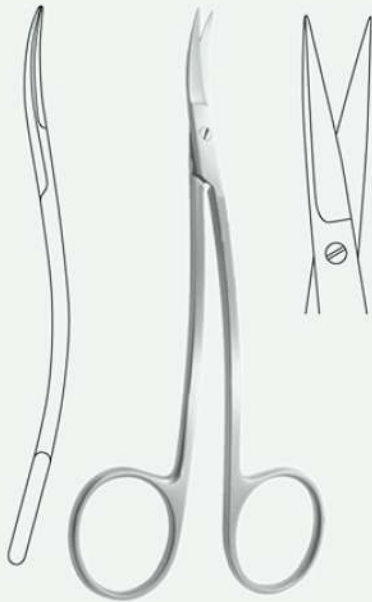

La Grange

CFS-04-400-14

14 cm - 5 1/2"



Neumann

CFS-04-401-12

12 cm - 4 3/4"

S-curved
 S-förmig gebogen
 curva en S
 courbes en S



Walter

CFS-04-402-10

10 cm - 4"

angled
 abgewinkelt
 angular
 abgewinkelt



Knapp

CFS-04-403-10

10.5 cm - 4 1/4"

blunt
stumpf
roma
mousses



CFS-04-404-10

10.5 cm - 4 1/4"



Knapp

CFS-04-405-12

12.5 cm - 5"

CFS-04-407-12T

12.5 cm - 5"

CFS-04-409-12S

12.5 cm - 5"



CFS-04-404-12

12.5 cm - 5"

CFS-04-408-12T

12.5 cm - 5"

CFS-04-410-12S

12.5 cm - 5"



Knapp

CFS-04-411-12

CFS-04-415-12S

sharp
spitz
puntiagudo
pointu



CFS-04-412-12

CFS-04-412-12S

blunt
stumpf
roma
mousses



CFS-04-413-12

CFS-04-416-12S

sharp
spitz
puntiagudo
pointu



CFS-04-414-12

CFS-04-414-12S

blunt
stumpf
roma
mousses

12 cm - 4 3/4"

12 cm - 4 3/4"



Knapp

CFS-04-417-10

10 cm - 4"



CFS-04-418-10

10 cm - 4"



Knapp

CFS-04-419-09

9.5 cm - 3 3/4"



<p>Siegert</p> <p>CFS-04-420-11T 11.5 cm - 4 1/2"</p> <p>CFS-04-422-11S 11.5 cm - 4 1/2"</p>		<p>Shea</p> <p>CFS-04-424-12 12 cm - 4 3/4"</p> <p>CFS-04-425-12S 12 cm - 4 3/4"</p>			
<p>Peck-Joseph</p> <p>CFS-04-427-14T 14 cm - 5 1/2"</p> <p>CFS-04-431-14S 14 cm - 5 1/2"</p>		<p>CFS-04-428-14T 14 cm - 5 1/2"</p> <p>CFS-04-432-14S 14 cm - 5 1/2"</p>		<p>CFS-04-429-14T 14 cm - 5 1/2"</p> <p>CFS-04-433-14S 14 cm - 5 1/2"</p>	
<p>Goldmann-Fox</p> <p>CFS-04-435-13 13 cm - 5 1/8" Saw edge</p>		<p>CFS-04-436-13 13 cm - 5 1/8" Saw edge</p>		<p>CFS-04-437-13T 13 cm - 5 1/8"</p> <p>CFS-04-438-13T 13 cm - 5 1/8"</p> <p>CFS-04-439-13S 13 cm - 5 1/8"</p>	

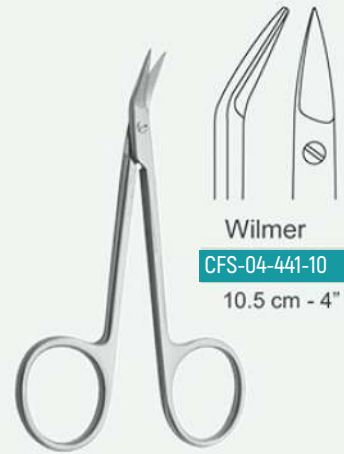

<p>Joseph</p> <p>CFS-04-449-14 14 cm / 5 1/2"</p> <p>CFS-04-451-14T 14 cm / 5 1/2"</p> <p>CFS-04-453-14S 14 cm / 5 1/2"</p>	<p>CFS-04-450-14 14 cm / 5 1/2"</p> <p>CFS-04-452-14T 14 cm / 5 1/2"</p> <p>CFS-04-454-14S 14 cm / 5 1/2"</p>	<p>Sanvenero</p> <p>CFS-04-455-14 14 cm - 5 1/2"</p> <p>CFS-04-456-14 14 cm - 5 1/2"</p>	<p>Mod. Bonn</p> <p>CFS-04-457-08 8 cm - 3 1/4"</p> <p>CFS-04-458-08 8 cm - 3 1/4"</p>		
<p>Kilner (Ragnell)</p>	<p>CFS-04-459-13 13.5 cm - 5"</p> <p>straight gerade recta droits</p>	<p>CFS-04-460-12 12 cm - 4 3/4"</p> <p>CFS-04-460-15 15 cm - 6"</p> <p>CFS-04-460-18 18 cm - 7"</p> <p>curved gebogen curva courbes</p>	<p>CFS-04-461-12T 12 cm - 4 3/4"</p> <p>CFS-04-461-15T 15 cm - 6"</p> <p>CFS-04-461-18T 18 cm - 7"</p> <p>curved gebogen curva courbes</p>	<p>CFS-04-462-12S 12 cm - 4 3/4"</p> <p>CFS-04-462-15S 15 cm - 6"</p> <p>CFS-04-462-18S 18 cm - 7"</p> <p>CFS-04-462-20S 20 cm - 8"</p> <p>CFS-04-462-23S 23 cm - 9"</p> <p>curved gebogen curva courbes</p>	<p>CFS-04-463-11 11 cm - 4 1/4"</p> <p>fine fein multa amende</p>

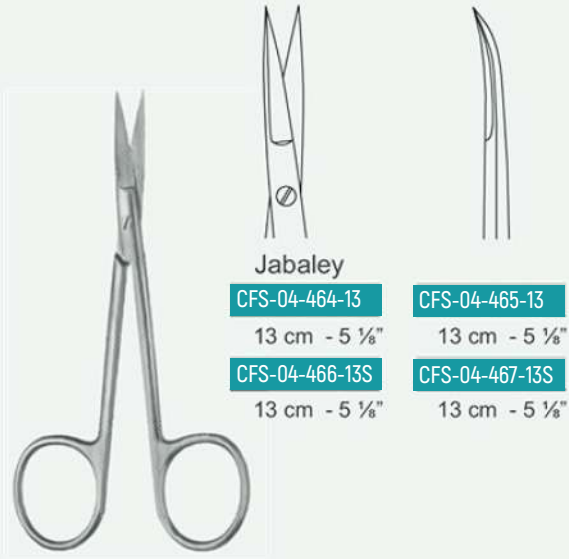

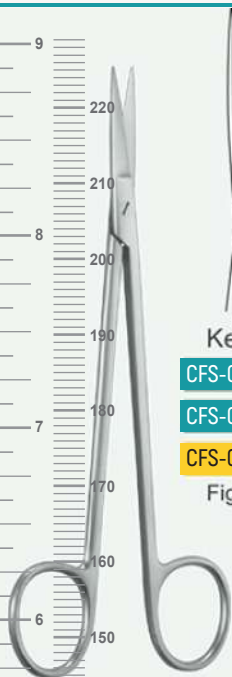

Kelly

CFS-04-473-16	CFS-04-474-16	CFS-04-475-16	16 cm - 6 ¼"
CFS-04-473-18	CFS-04-474-18	CFS-04-475-18	18 cm - 7"
CFS-04-473-16T	CFS-04-476-16T	CFS-04-477-16T	16 cm - 6 ¼"

Fig. 1 Fig. 2 Fig. 3



Bruser-Kelly
 CFS-04-479-16S
 16 cm - 6¼"



Strabismus

CFS-04-480-09	CFS-04-481-09	9 cm - 3 ½"
CFS-04-480-11	CFS-04-481-11	11.5 cm - 4 ¼"



Landoldt

CFS-04-484-12	CFS-04-485-12	12 cm - 4 ¾"
---------------	---------------	--------------

CFS-04-482-11	CFS-04-483-11	11.5 cm - 4 ¼"
---------------	---------------	----------------

fine
fein
multa
amende

fine
fein
multa
amende

CFS-04-486-12	CFS-04-487-12	12 cm - 4 ¾"
---------------	---------------	--------------

INCHES
MILLIMETERS

Plastic Surgery Scissors

Scheren für die plastische Chirurgie

Tijeras Para Cirugía Plástica

Ciseaux Pour la chirurgie Plastique

Forbici di chirurgia plastica

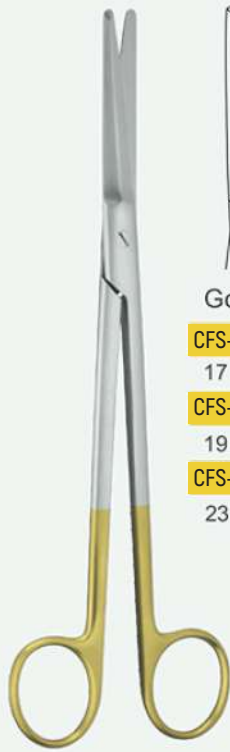

Gorney

CFS-04-488-17T

17 cm - 6 3/4"

CFS-04-488-19T

19 cm - 6 1/2"

CFS-04-488-23T

23 cm - 9"

CFS-04-489-17T

17 cm - 6 3/4"

CFS-04-489-19T

19 cm - 6 1/2"

CFS-04-489-23T

23 cm - 9"

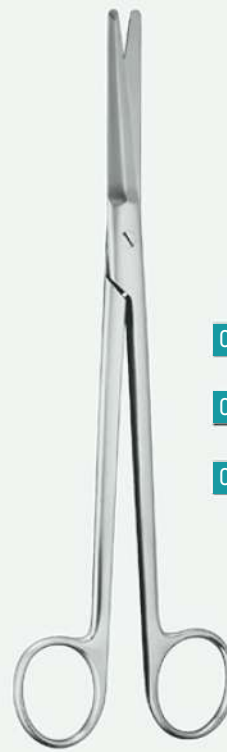

Gorney

CFS-04-490-17S

17 cm - 6 3/4"

CFS-04-490-19S

19 cm - 6 1/2"

CFS-04-490-23S

23 cm - 9"

CFS-04-491-17S

17 cm - 6 3/4"

CFS-04-491-19S

19 cm - 6 1/2"

CFS-04-491-23S

23 cm - 9"



Gorney-Freeman

CFS-04-492-17T

17 cm - 6 3/4"

CFS-04-492-19T

19 cm - 6 1/2"

CFS-04-492-23T

23 cm - 6"

CFS-04-493-17S

17 cm - 6 3/4"

CFS-04-493-19S

19 cm - 6 1/2"

CFS-04-493-23S

23 cm - 6"

flat tips
flache Spitzen
planes de Puntas
pointes plates

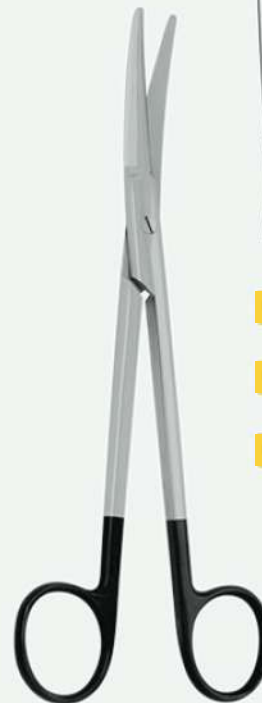

Kaye

CFS-04-499-15T

15 cm - 6"

CFS-04-499-19T

19 cm - 7 1/2"

CFS-04-499-23T

23 cm - 9"

CFS-04-500-15S

15 cm - 6"

CFS-04-500-17S

17 cm - 6 3/4"

CFS-04-500-19S

19 cm - 7 1/2"

CFS-04-500-23S

23 cm - 9"



Plastic Surgery Scissors

Scheren für die plastische Chirurgie

Tijeras Para Cirugía Plástica

Ciseaux Pour la chirurgie Plastique

Forbici di chirurgia plastica



Kaye
CFS-04-502-11
11.5 cm - 4 1/2"



Kaye
CFS-04-503-11T
11.5 cm - 4 1/2"
CFS-04-504-11S
11.5 cm - 4 1/2"



Kaye
CFS-04-505-11s
11.5 cm - 4 1/2"



Rees
CFS-04-504-19T
19.5 cm - 7 3/4"



Hinderer
CFS-04-507-19T
19.5 cm - 7 3/4"



Kaye-Freeman
CFS-04-508-18T
18 cm - 7"
CFS-04-510-18S
18 cm - 7"



Carlos

CFS-04-511-14

14.5 cm - 5 3/4"

- 1 Blade with probe
- 1 Blatt mit Sondenspitze
- 1 Punta forma sonda
- 1 Lame avec sonde



Perwitschky

CFS-04-512-11

11.5 cm - 4 1/2"

CFS-04-513-11

11.5 cm - 4 1/2"



Perwitschky

CFS-04-514-11

11.5 cm - 4 1/2"

CFS-04-515-11

11.5 cm - 4 1/2"

- probe-pointed tip
- geknöpfte Spitze
- top abotonado
- haut boutonné



Lincoln

CFS-04-516-17

17 cm - 6 3/4"



CFS-04-517-17

17 cm - 6 3/4"



Fulton

CFS-04-518-17

17 cm - 6 3/4"



Potts-Smith
(de Martel)

CFS-04-519-45 45°

21 cm - 8 1/4"

CFS-04-519-60 60°

21 cm - 8 1/4"





Willauer

CFS-04-520-25

25 cm - 10"

CFS-04-520-28

28 cm - 11"



Favaloro

CFS-04-521-14

14 cm - 5 1/2"

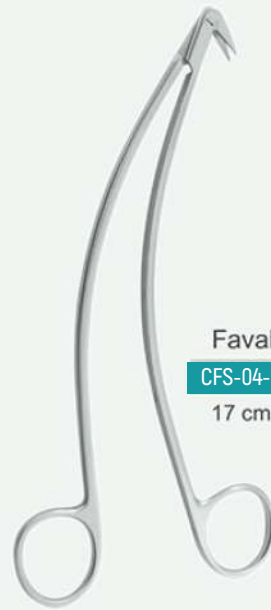

Favaloro

CFS-04-522-17

130°

17 cm - 6 3/4"

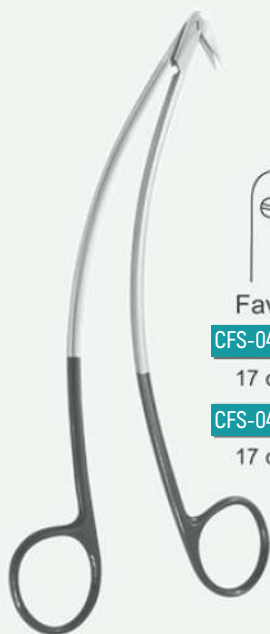

Favaloro

CFS-04-523-08S 8 mm

17 cm - 6 3/4"

CFS-04-523-12S 12 mm

17 cm - 6 3/4"

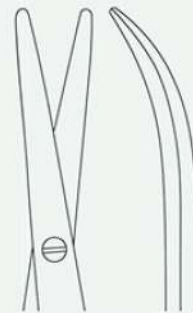

DeBakey

CFS-04-524-18

18 cm - 7 1/4"



De Bakey

CFS-04-525-16	CFS-04-526-16	CFS-04-527-16	16 cm - 6 ¼"
CFS-04-525-23	CFS-04-526-23	CFS-04-527-23	23 cm - 9"
CFS-04-525-28	CFS-04-526-28	CFS-04-527-28	28 cm - 11"

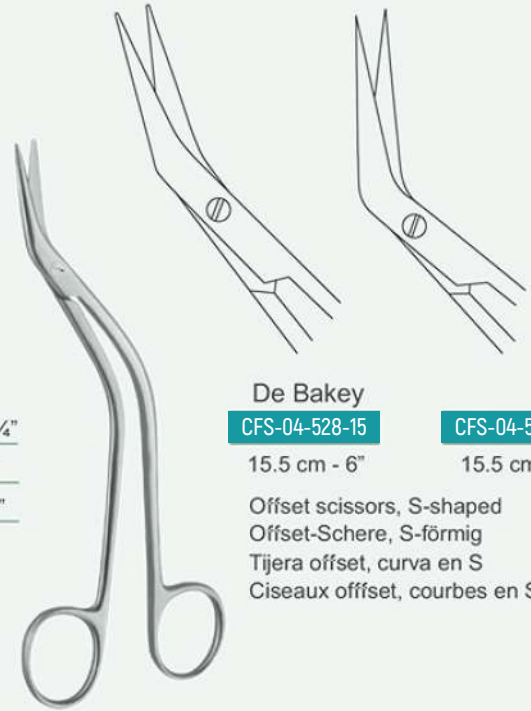

De Bakey

CFS-04-528-15	CFS-04-529-15
15.5 cm - 6"	15.5 cm - 6"

Offset scissors, S-shaped
 Offset-Schere, S-förmig
 Tijera offset, curva en S
 Ciseaux offset, courbes en S



De Bakey

CFS-04-530-16T	CFS-04-531-16T	CFS-04-532-16T	16 cm - 6 ¼"
CFS-04-530-23T	CFS-04-531-23T	CFS-04-532-23T	23 cm - 9"
CFS-04-530-28T	CFS-04-531-28T	CFS-04-532-28T	28 cm - 11"



Mills

CFS-04-533-22
22.5 cm - 8 ¾"



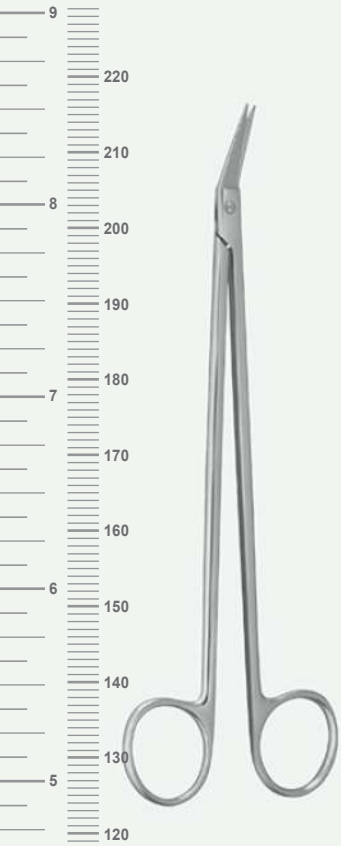

Potts-de Martel

CFS-04-534-19



45°

CFS-04-535-19

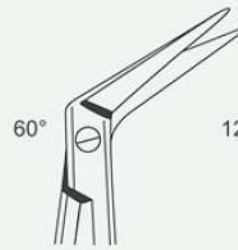

60°

CFS-04-536-19



125°

CFS-04-537-19 19 cm - 7 1/2"

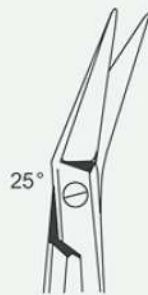
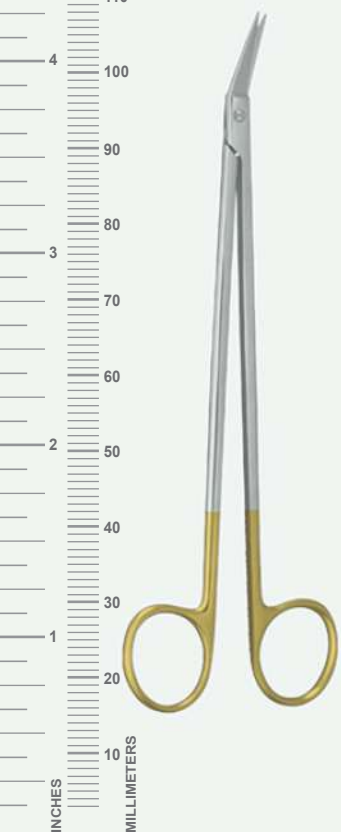

25°

Potts- de Martel

CFS-04-538-19T

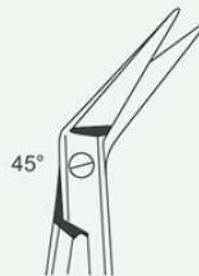

45°

CFS-04-539-19T



60°

CFS-04-540-19T 19 cm - 7 1/2 "

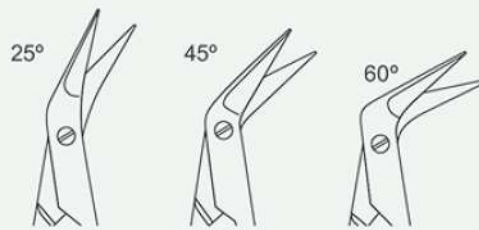
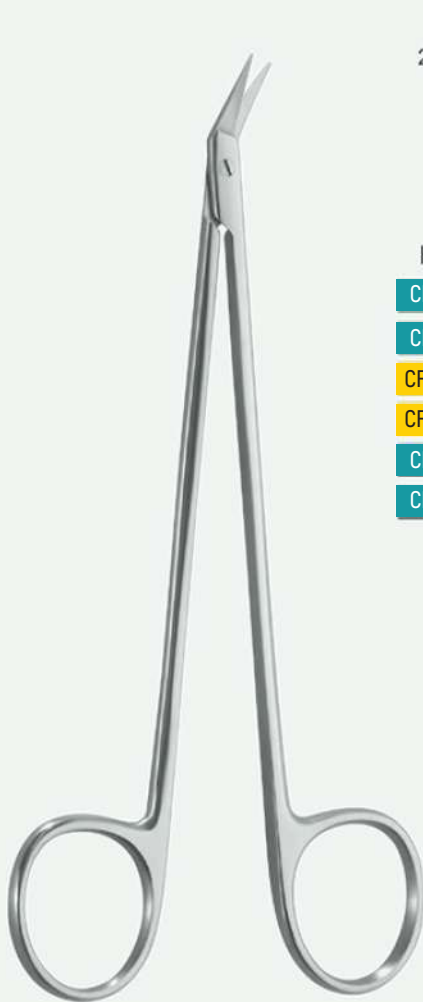

Hegemann - Diethrich

CFS-04-541-12	CFS-04-542-12	CFS-04-543-12	12 cm - 4 ¾"	12 mm
CFS-04-541-14	CFS-04-542-14	CFS-04-543-14	14 cm - 5 ½"	14 mm
CFS-04-544-12T	CFS-04-545-12T	CFS-04-546-12T	12 cm - 4 ¾"	12 mm
CFS-04-544-14T	CFS-04-545-14T	CFS-04-546-14T	14 cm - 5 ½"	14 mm
CFS-04-547-12S	CFS-04-548-12S	CFS-04-549-12S	12 cm - 4 ¾"	12 mm
CFS-04-547-14S	CFS-04-548-14S	CFS-04-549-14S	14 cm - 5 ½"	14 mm

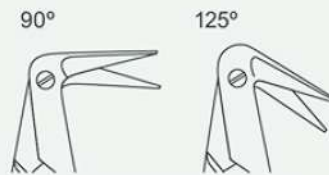

CFS-04-550-12	CFS-04-551-12	12 cm - 4 ¾"	12 mm
CFS-04-550-14	CFS-04-551-14	14 cm - 5 ½"	14 mm
CFS-04-552-12T	CFS-04-553-12T	12 cm - 4 ¾"	12 mm
CFS-04-552-14T	CFS-04-553-14T	14 cm - 5 ½"	14 mm
CFS-04-554-12S	CFS-04-553-12S	12 cm - 4 ¾"	12 mm
CFS-04-554-14S	CFS-04-553-14S	14 cm - 5 ½"	14 mm



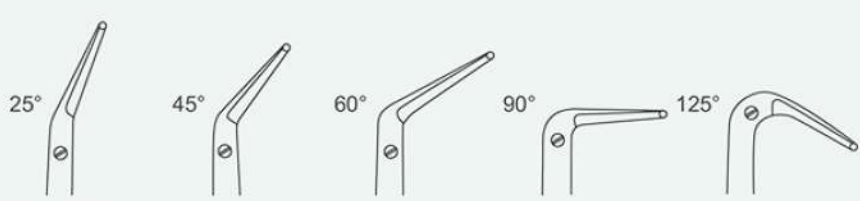
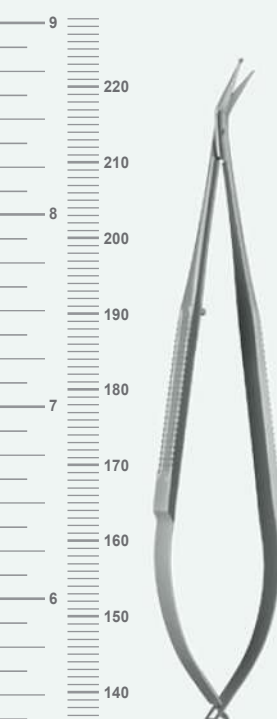

Potts - De Martel
 CFS-04-560-18 CFS-04-561-18 CFS-04-562-18 CFS-04-563-18 CFS-04-564-18 18 cm - 7"



CFS-04-565-18 CFS-04-566-18 CFS-04-567-18 CFS-04-568-18 CFS-04-569-18 18 cm - 7"

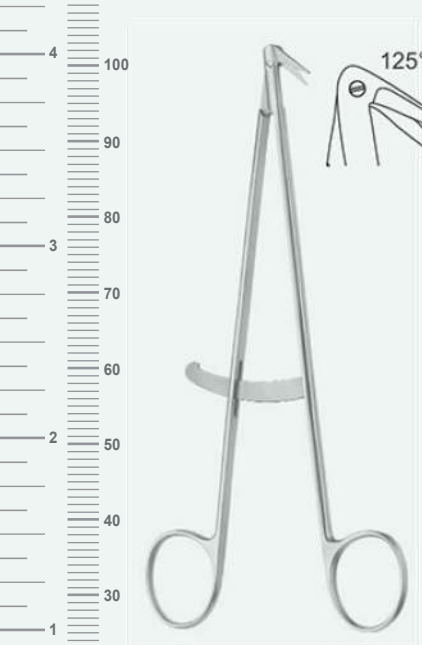

Hegemann-Diethrich
 CFS-04-570-18
 18 cm - 7"



Mattox-Potts
 CFS-04-571-14
 14 cm - 5 1/2"

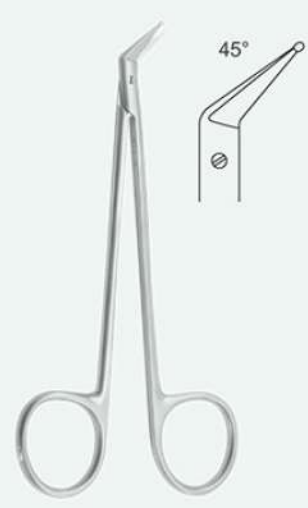

Hegemann
 CFS-04-572-13
 13 cm - 5"

INCHES
 MILLIMETERS

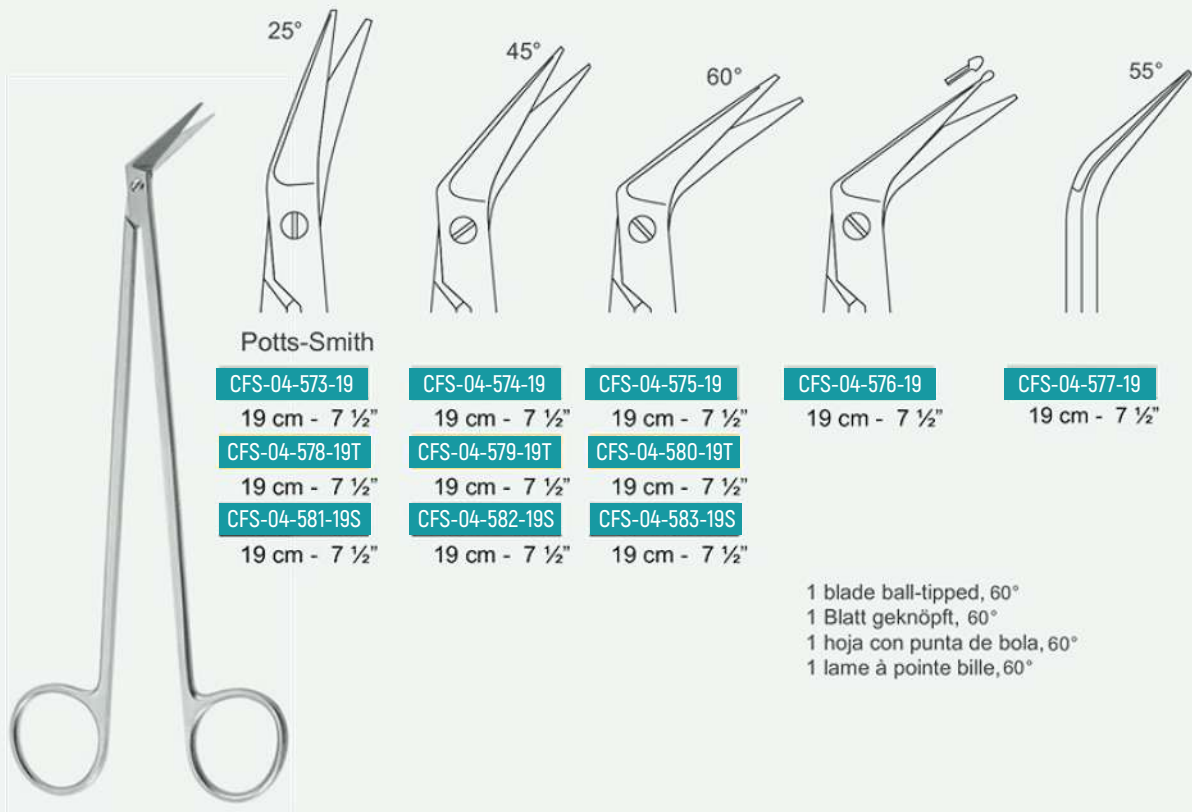



Alar
CFS-04-584-12
 12 cm / 4 3/4"
 Knorpelschere
 Cartilage Scissors
 Tijera de cartilago



Martin-Cartilage
CFS-04-589-19
 19 cm - 7 1/2"
 curved, sawedge
 gebogen, gezahnt
 curva, dentada
 courbes, dentelés

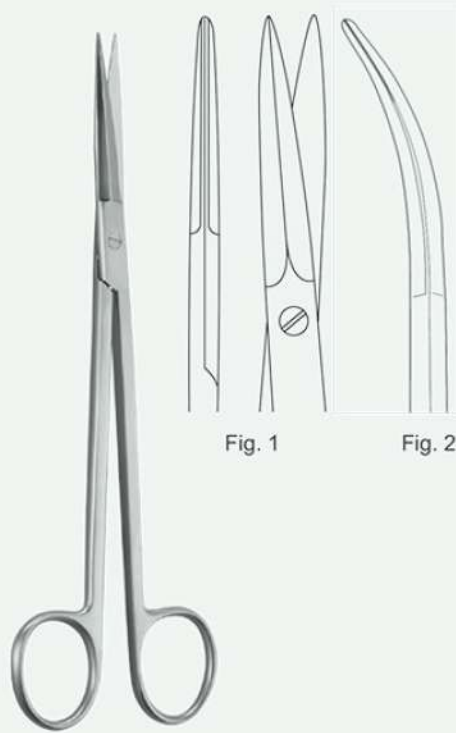

Mc Indoe
CFS-04-590-01 Fig. 1
CFS-04-590-02 Fig. 2
 19 cm - 7 1/2"



Potts-Smith
CFS-04-591-19
 19 cm - 7 1/2"



Boettcher
CFS-04-592-18
 18 cm - 7"



Prince
CFS-04-593-18
 18 cm - 7"



Toennis
CFS-04-594-18
 18 mm - 7"
 fine
 fein
 multa
 amende



CFS-04-595-18
 18 mm - 7"
 fine
 fein
 multa
 amende



CFS-04-596-18
 18 mm - 7"
 very fine
 sehr fein
 muy fino
 très bien



Toennis-Adson
CFS-04-597-17
 17.5 cm - 7 3/4"
 fine
 fein
 multa
 amende



CFS-04-598-17
 17.5 cm - 7 3/4"
 very fine
 sehr fein
 muy fino
 très bien



Toennis-Adson
CFS-04-599-17T
 17.5 cm - 7 3/4"
CFS-04-601-17S
 17.5 cm - 7 3/4"
 fine
 fein
 multa
 amende



CFS-04-600-17T
 17.5 cm - 7 3/4"
CFS-04-602-17S
 17.5 cm - 7 3/4"
 very fine
 sehr fein
 muy fino
 très bien





Wertheim
CFS-04-603-20
 20 cm - 8"



Friedland
CFS-04-604-20T
 18 cm - 7"
CFS-04-604-23T
 23 cm - 9"



Good
CFS-04-605-19
 19 cm - 7 1/2"

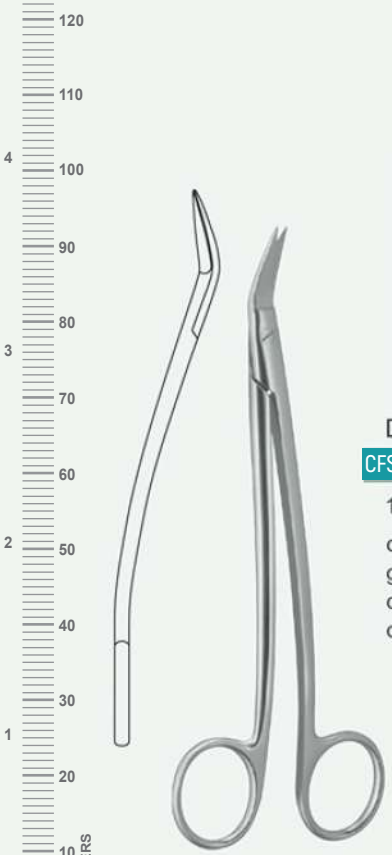

Dean
CFS-04-606-17
 17 cm - 6 3/4"
 curved
 gebogen
 curva
 courbes

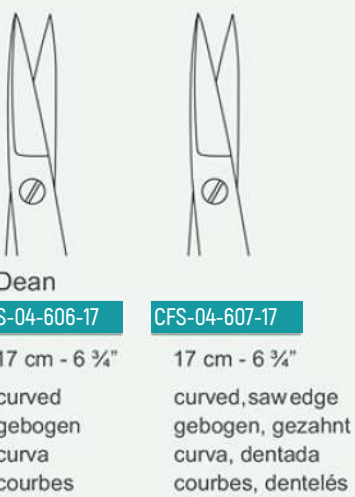

CFS-04-607-17
 17 cm - 6 3/4"
 curved, saw edge
 gebogen, gezahnt
 curva, dentada
 courbes, dentelés

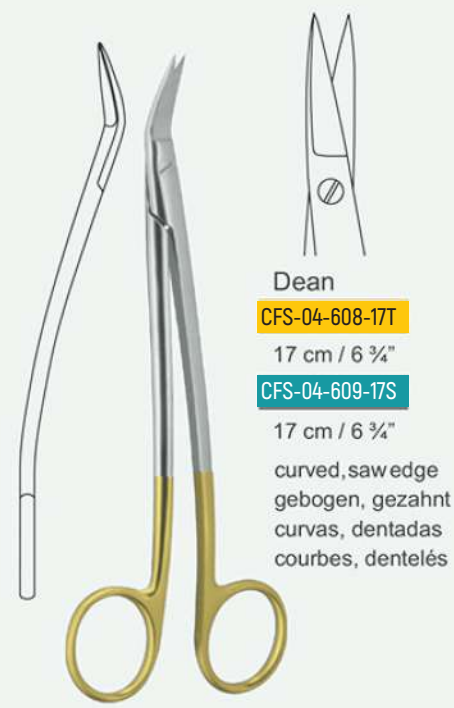

Dean
CFS-04-608-17T
 17 cm / 6 3/4"
CFS-04-609-17S
 17 cm / 6 3/4"
 curved, saw edge
 gebogen, gezahnt
 curvas, dentadas
 courbes, dentelés

INCHES
 MILLIMETERS



Crafoord
CFS-04-610-30
 30 cm - 12"



Willauer
CFS-04-611-25
CFS-04-611-28

straight
 gerade
 recta
 droits



CFS-04-612-25 25 cm - 9 3/4"
CFS-04-612-28 28 cm - 11"

curved
 gebogen
 curva
 courbes

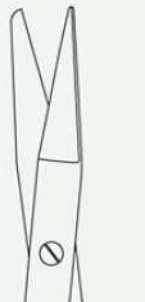

Resano
CFS-04-613-25
 25 cm - 10"



CFS-04-614-25S
 25 cm - 10"



Finochietto
CFS-04-615-27
 27 cm - 10 1/2"





Satinsky
CFS-04-616-18
 18 cm - 7 1/8"

Satinsky
CFS-04-617-24
 24.5 cm - 9 3/4"

Klinkenberg-Loth
CFS-04-618-23
 23 cm - 9"

Jorgenson
CFS-04-619-23
 23 cm - 9"

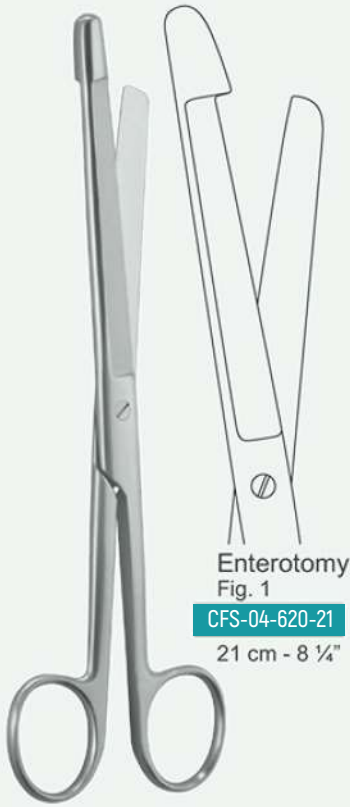

Enterotomy
 Fig. 1
CFS-04-620-21
 21 cm - 8 1/4"



Fig. 2
CFS-04-621-21
 21 cm - 8 1/4"

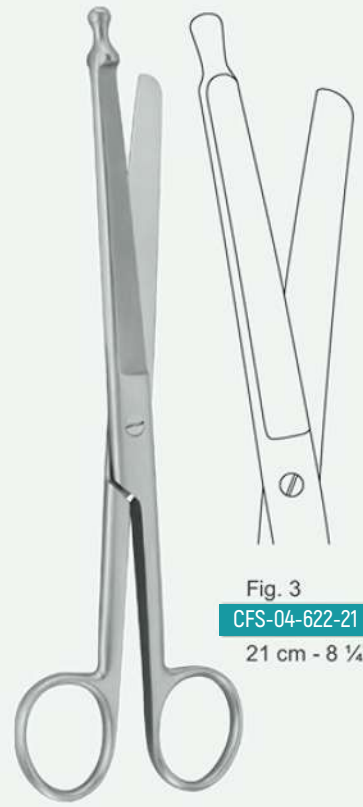

Fig. 3
CFS-04-622-21
 21 cm - 8 1/4"



Stelzner
CFS-04-623-31
 31 cm - 12 1/4"



Stelzner
CFS-04-624-32
 32.5 cm - 12 3/4"
 Heavy curve



Lloyd-Davies
 (Goligher's)
CFS-04-625-27
 27 cm - 10 1/2"



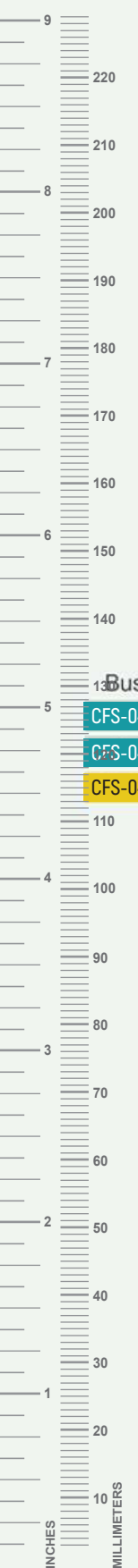

Busch

CFS-04-626-13	CFS-04-627-13	13 cm - 5"
CFS-04-626-16	CFS-04-627-16	16 cm - 6 ¼"
CFS-04-628-16T	CFS-04-629-16T	16 cm - 6 ¼"

saw edge
 gezahnt
 dentada
 dentelés



Schumacher
 CFS-04-629-16
 16 cm - 6 ¼"



USA Model
 CFS-04-630-10
 10.5 cm - 4 ¼"

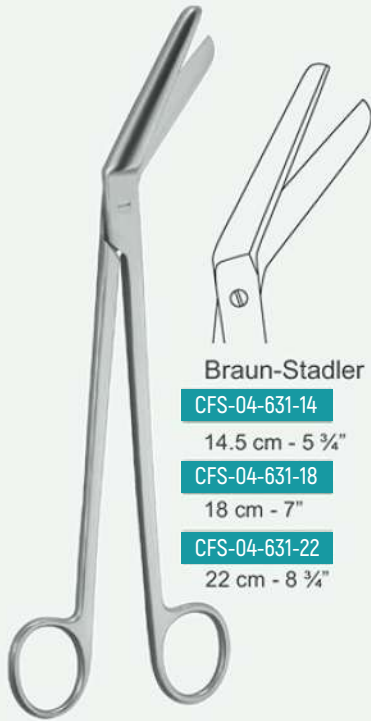

Braun-Stadler

CFS-04-631-14

14.5 cm - 5 3/4"

CFS-04-631-18

18 cm - 7"

CFS-04-631-22

22 cm - 8 3/4"



Waldmann

CFS-04-632-20

20 cm - 8"



Waldmann - Modified

CFS-04-634-20

20 cm - 8"

CFS-04-635-20T

20 cm - 8"

CFS-04-636-20S

20 cm - 8"



Tim

CFS-04-637-20

23 cm - 9"

CFS-04-638-23S

23 cm - 9"



9
220
210
200
190
180
170
160
150
140
130
120
110
100
90
80
70
60
50
40
30
20
10
INCHES
MILLIMETERS



Heymann
CFS-04-639-17
 17 cm - 7"



CFS-04-640-17
 17 cm - 7"



CFS-04-641-18S
 18 cm - 7 1/8"

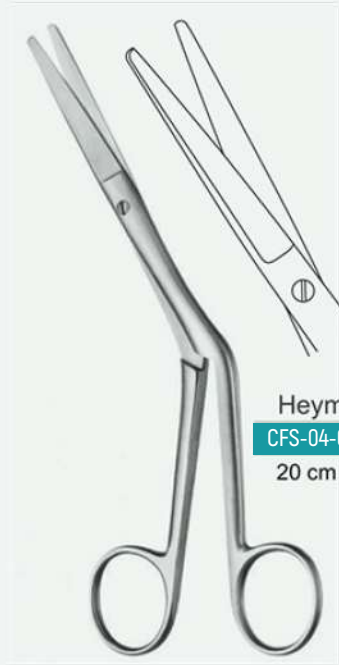

Heymann
CFS-04-642-20
 20 cm - 8"



Knight
CFS-04-643-17
 17 cm - 6 3/4"

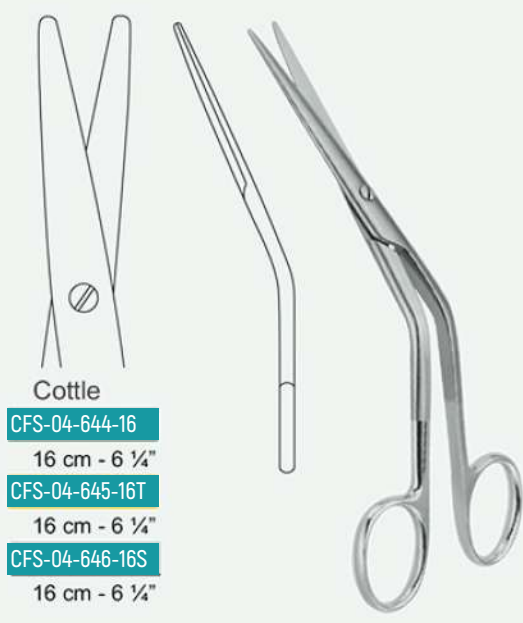

Cottle
CFS-04-644-16
 16 cm - 6 1/4"
CFS-04-645-16T
 16 cm - 6 1/4"
CFS-04-646-16S
 16 cm - 6 1/4"

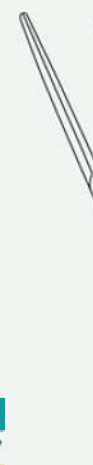



Fomon

CFS-04-647-15

15 cm - 6"

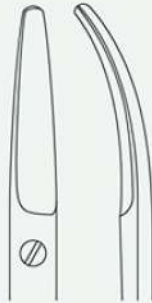

CFS-04-648-13

13 cm - 5"

CFS-04-649-13T

13 cm - 5"

CFS-04-650-13S

13 cm - 5"



CFS-04-651-14

14.5 cm - 5 3/4"

serrated
 gezahnt
 serrado
 denté



CFS-04-652-13

13.5 cm - 5 1/4"

light curved
 leicht gebogen
 ligeramente curvada
 légèrement incurvé



Olivecrona

CFS-04-652-23

23 cm - 9"

Trigeminal scissors
 Trigeminsusschere
 Tijera para nervio trigémino
 Ciseaux pour le trigéminis

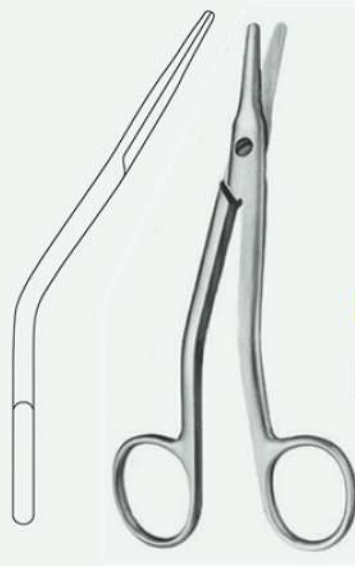

Walter-Cottle

CFS-04-653-16T

16 cm - 6 1/4"

CFS-04-654-16S

16 cm - 6 1/4"





Halle
 CFS-04-655-19
 19 cm - 7 1/2"



Sailer
 CFS-04-656-17
 17 cm - 6 3/4"

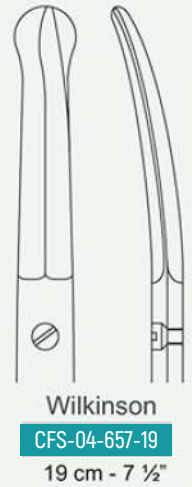

Wilkinson
 CFS-04-657-19
 19 cm - 7 1/2"

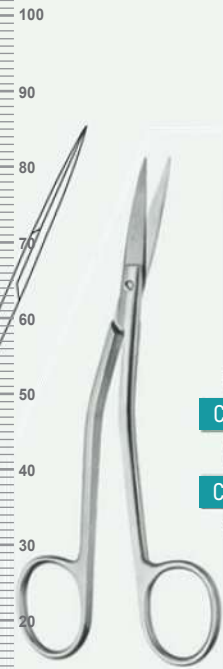

Fanous
 CFS-04-658-14
 14 cm - 5 1/2"
 CFS-04-659-14S
 14 cm - 5 1/2"



Obwegeser
 CFS-04-660-18
 18.5 cm - 7 1/4"
 CFS-04-660-20
 20 cm - 8"
 Undermining scissors
 Unterminierscheren
 Ciseaux à tunnelisation
 Tijeras para tunelización

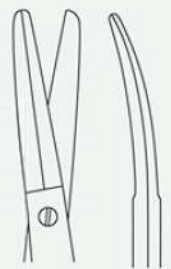

Fomon
 CFS-04-661-12
 12.5 cm - 5"
 both sides sharp
 beidseitig schneidend
 coupant des deux côtés
 cortantes por ambos lados

Hough
CFS-04-662-13
 13 cm - 5 1/8"

Giunta
CFS-04-663-13T
 13.5 cm - 5 3/8"

Aufrecht
CFS-04-664-14
 14 cm - 5 1/2"
CFS-04-665-14T
 14 cm - 5 1/2"
CFS-04-666-14S
 14 cm - 5 1/2"

Kahn
CFS-04-667-14
 14.5 cm - 5 3/4"

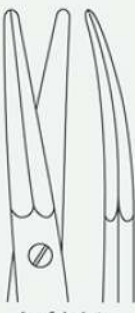
Walter
CFS-04-668-14
 14 cm - 5 1/2"



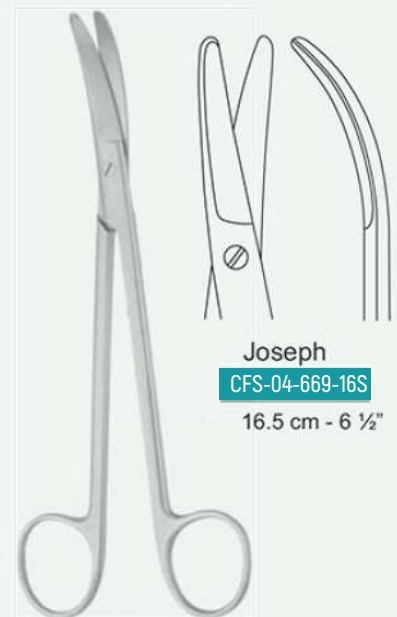

Joseph
CFS-04-669-16S
 16.5 cm - 6 1/2"

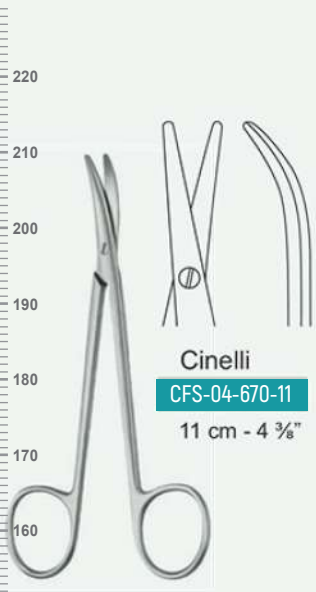

9
220
210
8
200
190
7
180
170
160
6
150
140
130
5
120
110
4
100
90
3
80
70
60
2
50
40
1
30
20
10
INCHES
MILLIMETERS

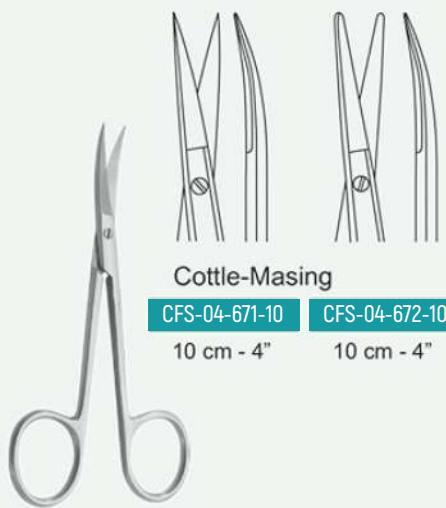

Cinelli
CFS-04-670-11
 11 cm - 4 3/8"



Cottle-Masing
CFS-04-671-10 **CFS-04-672-10**
 10 cm - 4" 10 cm - 4"



Converse
CFS-04-673-13
 13.5 cm - 5 3/8"
 Outer edges semisharp
 Außenkanten halbscharf
 Bords extérieurs semicortantes
 Bords extérieurs semi-tranchants



Cottle
CFS-04-674-11
 11.5 cm - 4 1/2"
 Bulldog scissors
 Bulldogschere
 Tijera Bulldog
 Ciseaux Bulldog

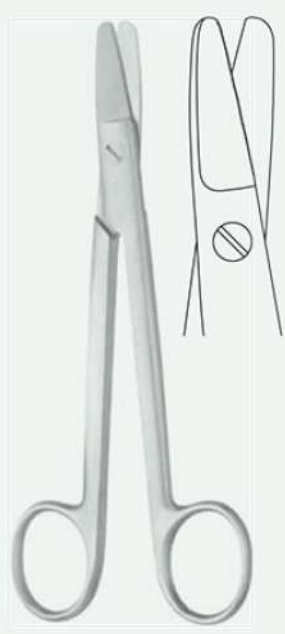

Castanares
CFS-04-675-16
 16 cm - 6 1/4"

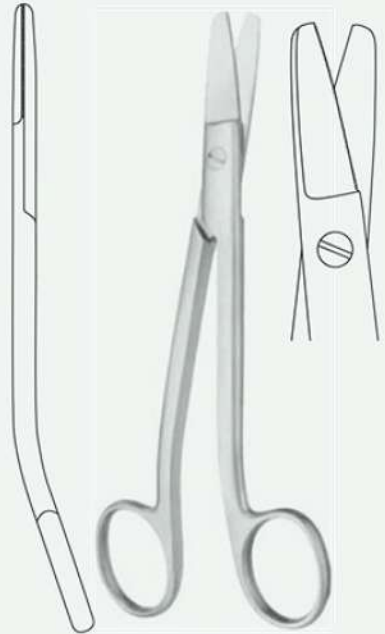

**Walter-Castanares
 Facelift**
CFS-04-676-16
 16 cm - 6 1/4"

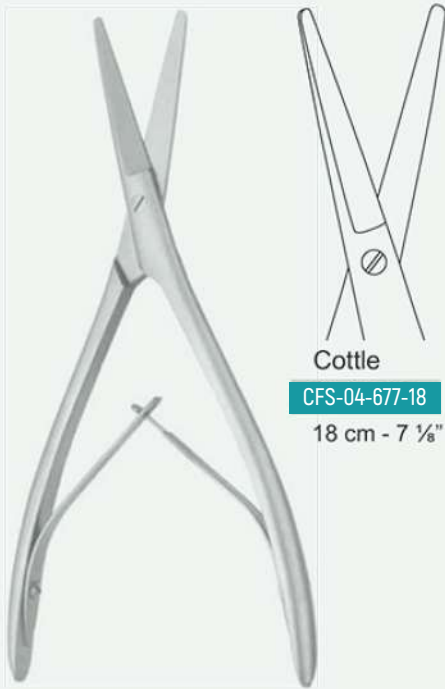

Cottle

CFS-04-677-18

18 cm - 7 1/8"

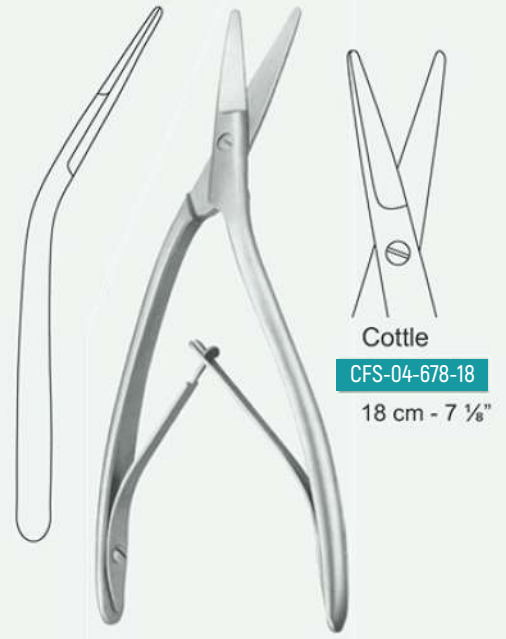

Cottle

CFS-04-678-18

18 cm - 7 1/8"

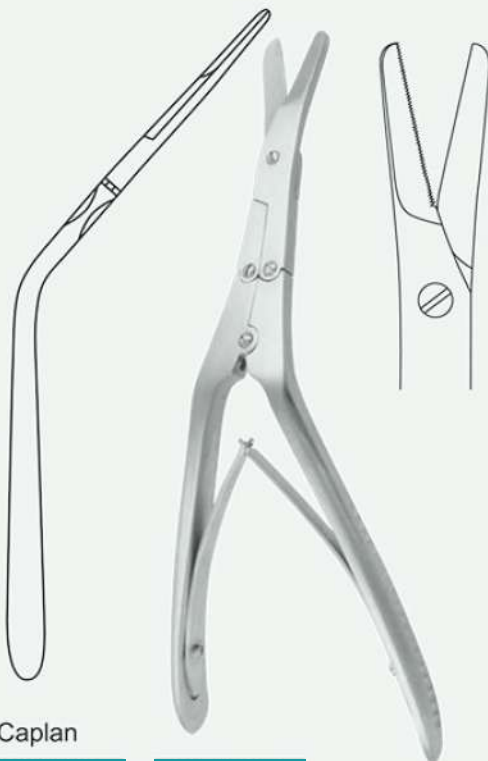

Caplan

CFS-04-679-22

22 cm - 8 5/8"

CFS-04-681-22T

22 cm - 8 5/8"

straight
 gerade
 recta
 droits

CFS-04-680-22

22 cm - 8 5/8"

CFS-04-682-22T

22 cm - 8 5/8"

curved
 gebogen
 curva
 courbes

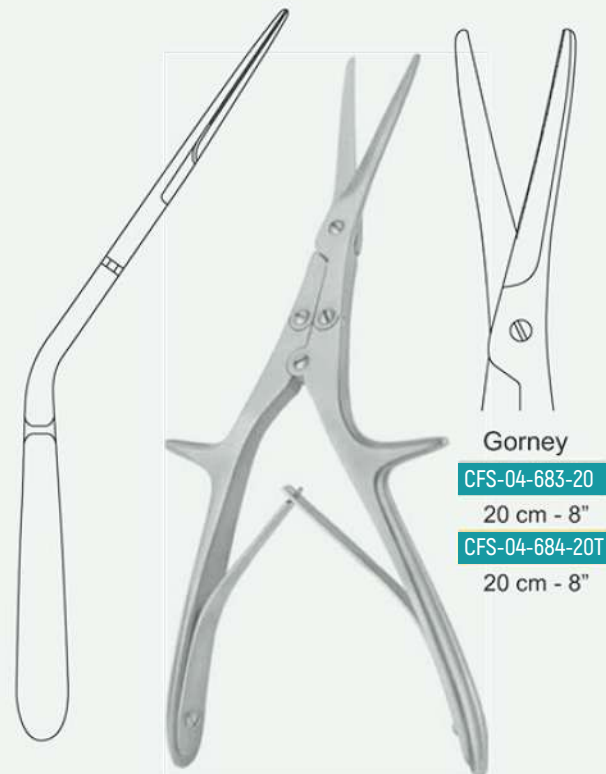

Gorney

CFS-04-683-20

20 cm - 8"

CFS-04-684-20T

20 cm - 8"





Geiger
 CFS-04-685-13
 13.5 cm - 5 3/8"

CFS-04-686-13
 13.5 cm - 5 3/8"

CFS-04-687-13
 13.5 cm - 5 3/8"

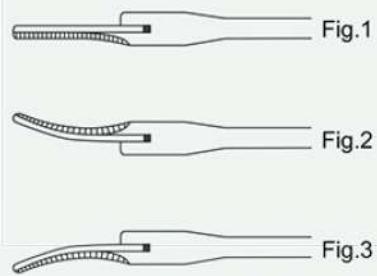

Obwegeser
 CFS-04-685-21
 CFS-04-686-21
 CFS-04-687-21
 21 cm - 8 1/4"

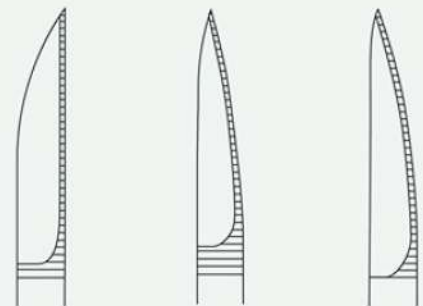

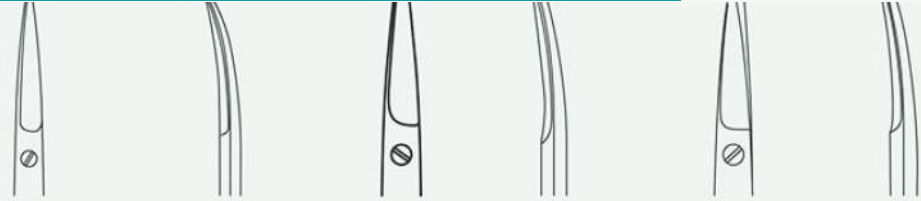

Iris

CFS-04-688-09	CFS-04-689-09	CFS-04-690-11	CFS-04-691-11	CFS-04-692-11	CFS-04-693-11
9 cm - 3 1/2"	9 cm - 3 1/2"	11.5 cm - 4 1/2"	11.5 cm - 4 1/2"	11.5 cm - 4 1/2"	11.5 cm - 4 1/2"
CFS-04-688-10	CFS-04-689-10				
10.5 cm - 4 1/8"	10.5 cm - 4 1/8"				
CFS-04-688-11	CFS-04-689-11				
11.5 cm - 4 1/2"	11.5 cm - 4 1/2"				
CFS-04-688-12	CFS-04-689-12				
12 cm - 4 3/4"	12 cm - 4 3/4"				



Iris

CFS-04-694-11T	CFS-04-695-11T	CFS-04-696-11T	11.5 cm - 4 1/2"
CFS-04-697-10S	CFS-04-698-10S	CFS-04-699-10S	10.5 cm - 4 1/8"
CFS-04-697-11S	CFS-04-698-11S	CFS-04-699-11S	11.5 cm - 4 1/2"
CFS-04-697-13S	CFS-04-698-13S	CFS-04-699-13S	13 cm - 5 1/8"

straight	curved	angular
gerade	gebogen	kniegebogen
recta	curva	acodada
droits	courbes	coudés

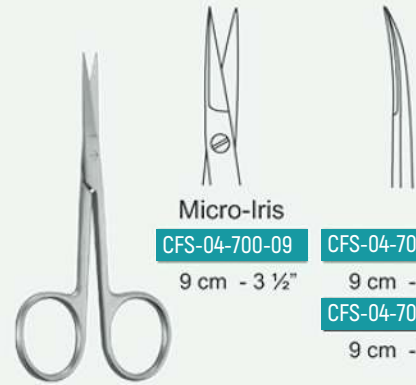

Micro-Iris

CFS-04-700-09	CFS-04-701-09
9 cm - 3 1/2"	9 cm - 3 1/2"
	CFS-04-702-09S
	9 cm - 3 1/2"

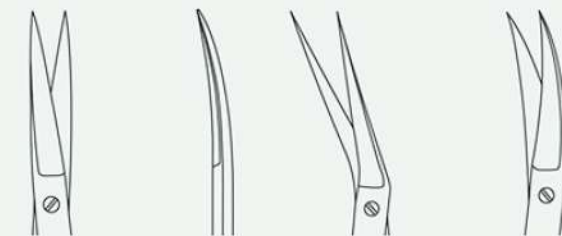

Iris

CFS-04-703-11	CFS-04-704-11	CFS-04-705-11	CFS-04-706-11	11.5 cm / 4 1/2"
CFS-04-707-10	CFS-04-708-10	CFS-04-709-10	CFS-04-710-10S	10.5 cm / 4 1/8"
CFS-04-707-11	CFS-04-708-11	CFS-04-709-11	CFS-04-710-11S	11.5 cm / 4 1/2"

straight	curved	angular	laterally curved
gerade	gebogen	kniegebogen	seitwärts gebogen
recta	curva	acodada	curva lateral
droits	courbes	coudés	courbes laterale



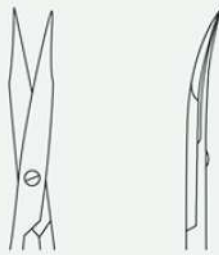

Stevens

CFS-04-711-10	CFS-04-712-10	10 cm - 4"
CFS-04-711-11	CFS-04-712-11	11 cm - 4 1/4"
CFS-04-713-11T	CFS-04-714-11T	11 cm - 4 1/4"
CFS-04-715-10S	CFS-04-716-10S	10 cm - 4"
CFS-04-715-11S	CFS-04-716-11S	11 cm - 4 1/4"
CFS-04-715-13S	CFS-04-716-13S	13.5 cm - 5 1/4"

sharp, sharp
 spitz, spitz
 aguda, aguda
 pointue, pointue

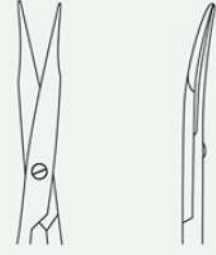
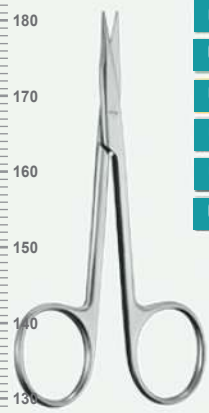

Stevens

CFS-04-717-10	CFS-04-718-10	10 cm - 4"
CFS-04-717-11	CFS-04-718-11	11 cm - 4 1/4"
CFS-04-719-11T	CFS-04-720-11T	11 cm - 4 1/4"
CFS-04-721-10S	CFS-04-722-10S	10 cm - 4"
CFS-04-721-11S	CFS-04-722-11S	11 cm - 4 1/4"
CFS-04-721-13S	CFS-04-722-13S	13.5 cm - 5 1/4"

blunt, blunt
 stumpf, stumpf
 roma, roma
 mousse, mousse



Stevens

CFS-04-723-18	18 cm - 7"
CFS-04-723-18S	18 cm - 7"



Stevens

CFS-04-724-11	11 cm - 4 1/2"
---------------	----------------

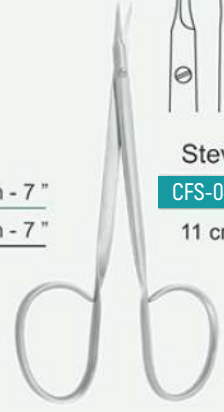

Walton

CFS-04-725-10	10 cm - 4"
---------------	------------



Graefe

CFS-04-726-10	10.5 cm - 4 1/4"
---------------	------------------

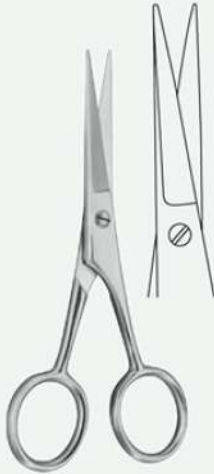

Carlos - Modified

CFS-04-727-11

CFS-04-727-13

CFS-04-727-14

Fig. 1



CFS-04-728-11 11.5 cm - 4 1/2"

CFS-04-728-13 13 cm - 5"

CFS-04-728-14 14 cm - 5 1/2"

Fig. 2

Nail splitting scissors
 Nagelspaltscheren
 Tijeras para uñas
 Ciseaux à ongles
 Forbici chiodo scissione



Split

CFS-04-826-13

13 cm - 5"

CFS-04-826-13

15 cm - 6"



Systrunk

CFS-04-827-13

13 cm - 5"

straight

gerade

recta

droits

CFS-04-827-15

13 cm - 5"

curved

gebogen

curva

courbes





Schmieden (Taylor)
CFS-04-729-14
 14.5 cm - 5 ¾"

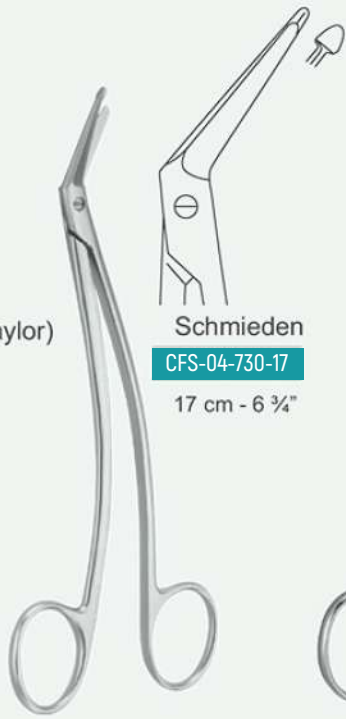

Schmieden
CFS-04-730-17
 17 cm - 6 ¾"

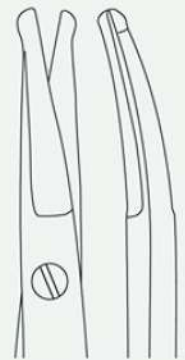

Stully
CFS-04-731-20
 20 cm - 8"



CFS-04-732-20
 20 cm - 8"

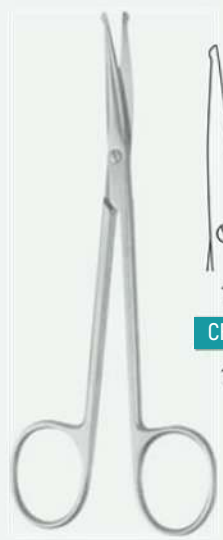

Taylor
CFS-04-733-14
 14 cm - 5 ½"

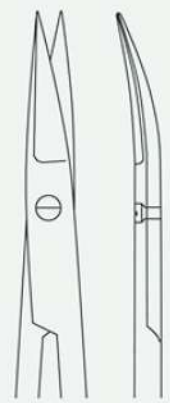

Dandy
CFS-04-734-17
 17 cm - 6 ¾"
CFS-04-734-19
 19 cm - 7 ½"

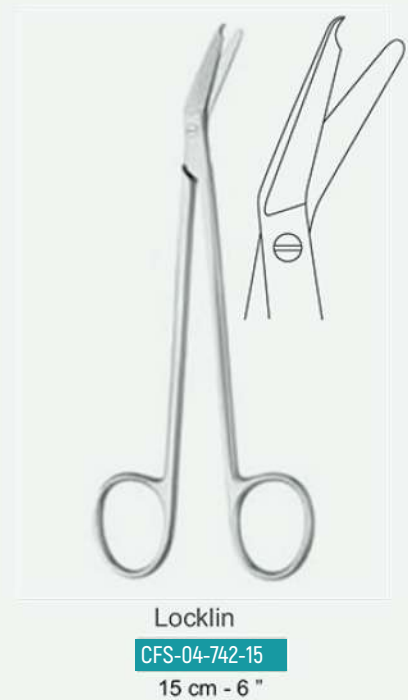
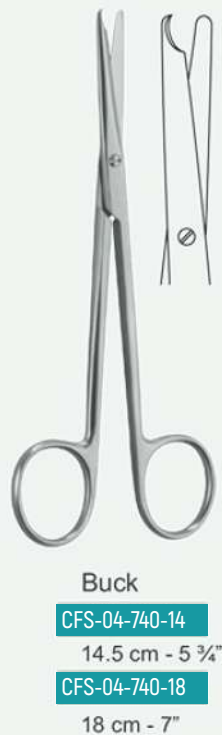
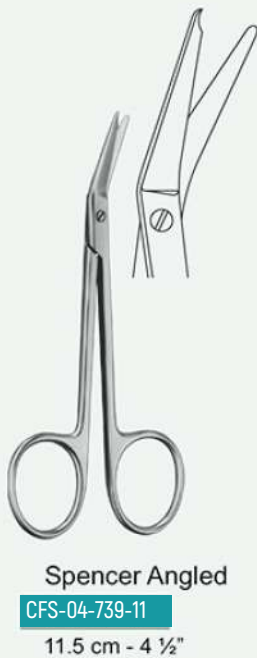
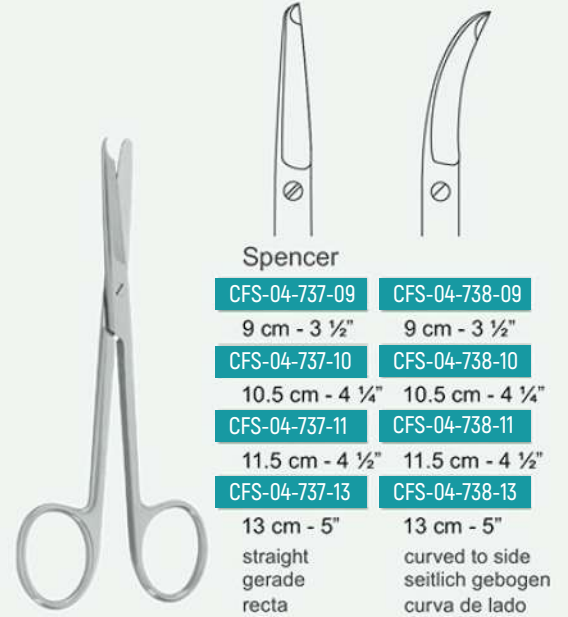
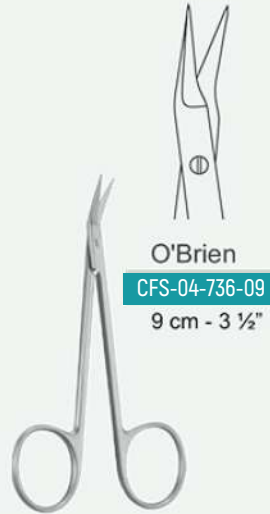

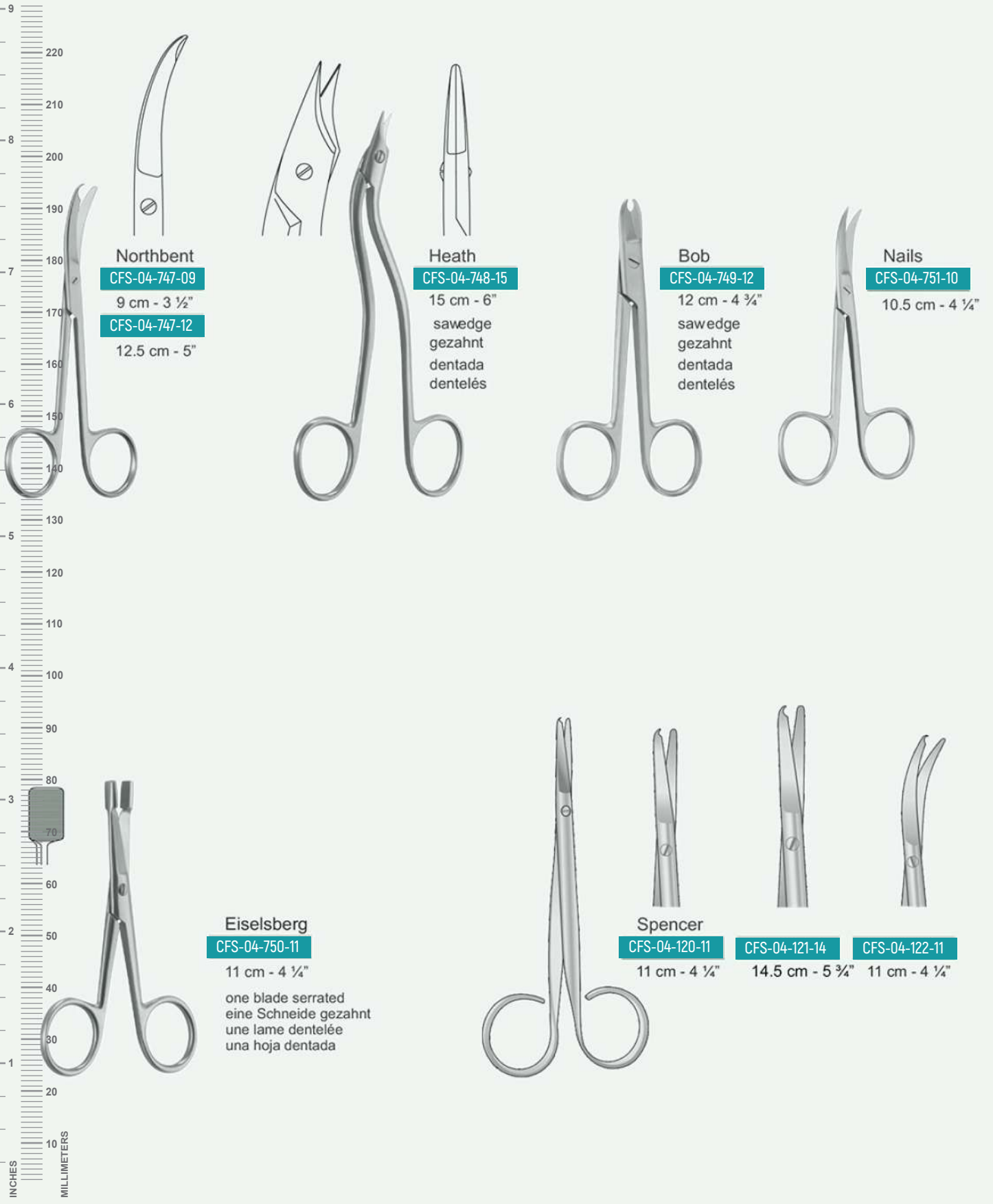

Northbent
CFS-04-747-09
 9 cm - 3 1/2"
CFS-04-747-12
 12.5 cm - 5"

Heath
CFS-04-748-15
 15 cm - 6"
 sawedge
 gezahnt
 dentada
 dentelés

Bob
CFS-04-749-12
 12 cm - 4 3/4"
 sawedge
 gezahnt
 dentada
 dentelés

Nails
CFS-04-751-10
 10.5 cm - 4 1/4"

Eiselsberg
CFS-04-750-11
 11 cm - 4 1/4"
 one blade serrated
 eine Schneide gezahnt
 une lame dentelée
 una hoja dentada

Spencer
CFS-04-120-11
 11 cm - 4 1/4"
CFS-04-121-14
 14.5 cm - 5 3/4"
CFS-04-122-11
 11 cm - 4 1/4"

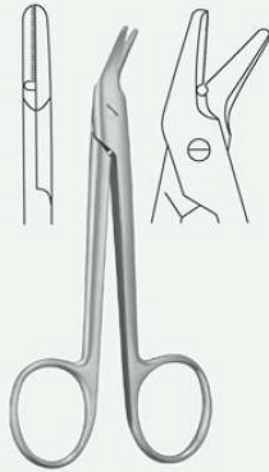

Universal
CFS-04-753-12

12 cm / 4 3/4"

sawedge
gezahnt
dentada
dentalés



Universal
CFS-04-754-12T

12 cm / 4 3/4"

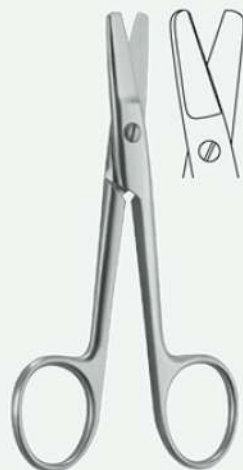

Harvey
CFS-04-756-12

12.5 cm / 5"

sawedge
gezahnt
dentada
dentalés



Schuhknecht
CFS-04-757-12

12.5 cm / 5"

sawedge
gezahnt
dentada
dentalés



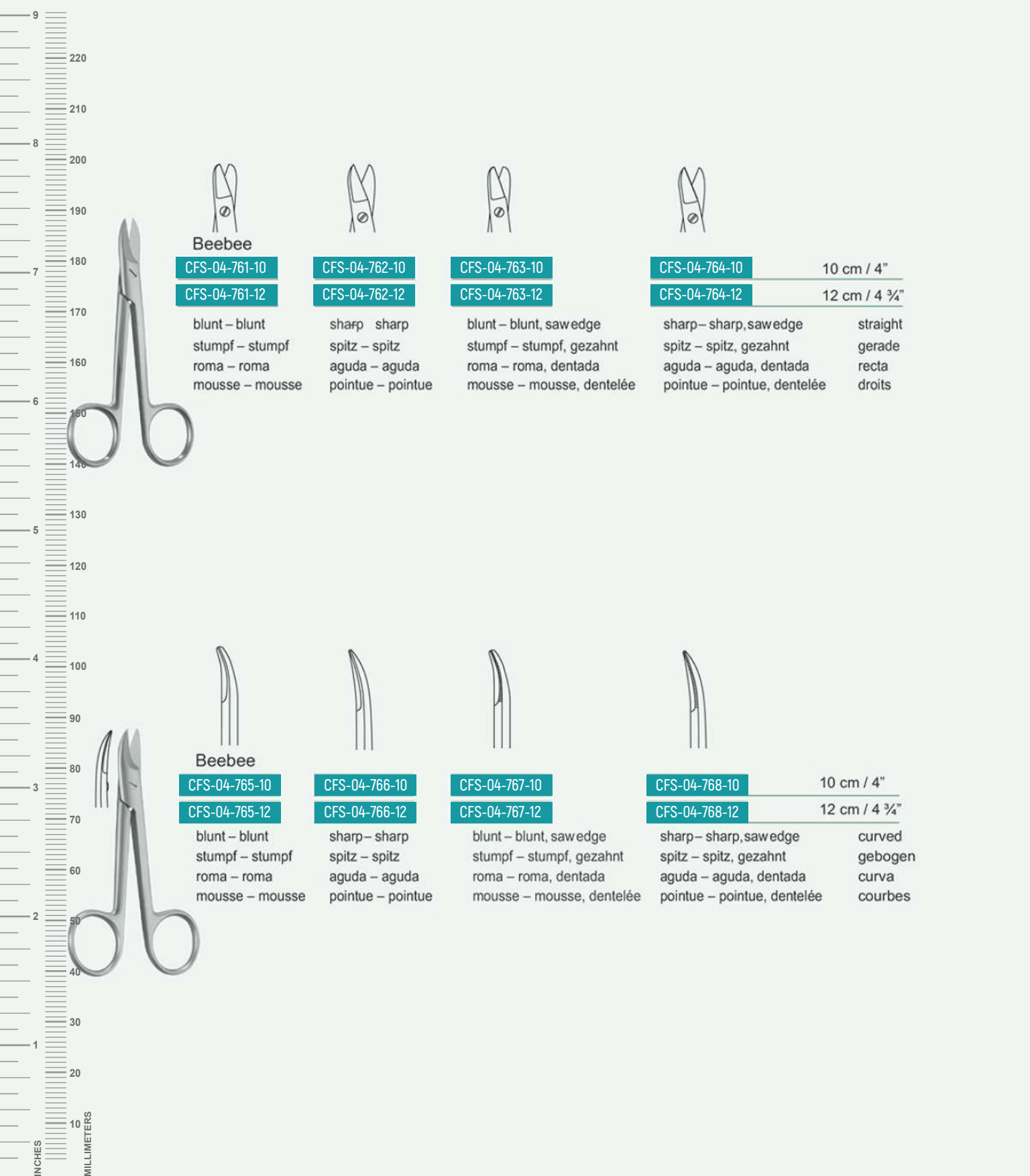

Beebee

CFS-04-761-10

CFS-04-761-12

blunt – blunt
 stumpf – stumpf
 roma – roma
 mousse – mousse



CFS-04-762-10

CFS-04-762-12

sharp sharp
 spitz – spitz
 aguda – aguda
 pointue – pointue



CFS-04-763-10

CFS-04-763-12

blunt – blunt, sawedge
 stumpf – stumpf, gezahnt
 roma – roma, dentada
 mousse – mousse, dentelée



CFS-04-764-10

CFS-04-764-12

sharp – sharp, sawedge
 spitz – spitz, gezahnt
 aguda – aguda, dentada
 pointue – pointue, dentelée

10 cm / 4"

12 cm / 4 ¾"

straight
 gerade
 recta
 droits

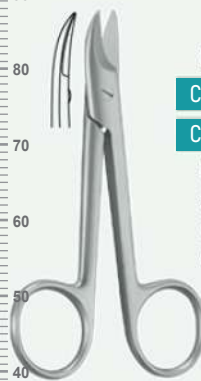

Beebee

CFS-04-765-10

CFS-04-765-12

blunt – blunt
 stumpf – stumpf
 roma – roma
 mousse – mousse



CFS-04-766-10

CFS-04-766-12

sharp – sharp
 spitz – spitz
 aguda – aguda
 pointue – pointue



CFS-04-767-10

CFS-04-767-12

blunt – blunt, sawedge
 stumpf – stumpf, gezahnt
 roma – roma, dentada
 mousse – mousse, dentelée



CFS-04-768-10

CFS-04-768-12

sharp – sharp, sawedge
 spitz – spitz, gezahnt
 aguda – aguda, dentada
 pointue – pointue, dentelée

10 cm / 4"

12 cm / 4 ¾"

curved
 gebogen
 curva
 courbes



Universal

Black	CFS-04-494-01	CFS-04-769-01	CFS-04-770-01
Blue	CFS-04-494-02	CFS-04-769-02	CFS-04-770-02
Green	CFS-04-494-03	CFS-04-769-03	CFS-04-770-03
Red	CFS-04-494-04	CFS-04-769-04	CFS-04-770-04
White	CFS-04-494-05	CFS-04-769-05	CFS-04-770-05
Orange	CFS-04-494-06	CFS-04-769-06	CFS-04-770-06
Pink	CFS-04-494-07	CFS-04-769-07	CFS-04-770-07
Yellow	CFS-04-494-08	CFS-04-769-08	CFS-04-770-08
Brown	CFS-04-494-09	CFS-04-769-09	CFS-04-770-09
Dark Red	CFS-04-494-10	CFS-04-769-10	CFS-04-770-10
Light Blue	CFS-04-494-11	CFS-04-769-11	CFS-04-770-11
Purple	CFS-04-494-12	CFS-04-769-12	CFS-04-770-12

11 cm - 4 1/4"
 Autoclavable
 Fig. 1

16 cm - 6 1/4"

18 cm - 7"



Universal

Black	CFS-04-116-01	CFS-04-117-01	CFS-04-118-01
Blue	CFS-04-116-02	CFS-04-117-02	CFS-04-118-02
Green	CFS-04-116-03	CFS-04-117-03	CFS-04-118-03
Purple	CFS-04-116-04	CFS-04-117-04	CFS-04-118-04
Orange	CFS-04-116-05	CFS-04-117-05	CFS-04-118-05
Red	CFS-04-116-06	CFS-04-117-06	CFS-04-118-06
Yellow	CFS-04-116-07	CFS-04-117-07	CFS-04-118-07

11 cm - 4 1/4"
 With plastic tip
 Autoclavable
 Fig. 2

16 cm - 6 1/4"

18 cm - 7"



Snip

Blue	CFS-04-112-01	CFS-04-113-01	CFS-04-114-01
Yellow	CFS-04-112-02	CFS-04-113-02	CFS-04-114-02
Green	CFS-04-112-03	CFS-04-113-03	CFS-04-114-03
Pink	CFS-04-112-04	CFS-04-113-04	CFS-04-114-04
Orange	CFS-04-112-05	CFS-04-113-05	CFS-04-114-05
Red	CFS-04-112-06	CFS-04-113-06	CFS-04-114-06

12 cm - 4 3/4"
 Sharp / sharp
 Autoclavable

12 cm - 4 3/4"
 Sharp / blunt

12 cm - 4 3/4"
 Blunt / blunt



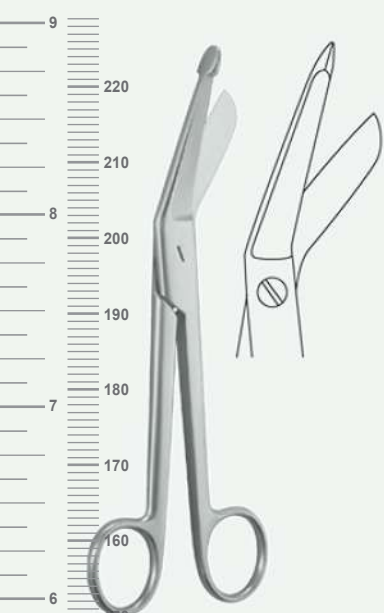

Lister

- CFS-04-771-09 9 cm - 3 1/2"
- CFS-04-771-11 11 cm - 4 1/4"
- CFS-04-771-14 14 cm - 5 1/2"
- CFS-04-771-18 18 cm - 7"
- CFS-04-771-20 20 cm - 8"
- CFS-04-771-25 25 cm - 10"
- CFS-04-771-30 30 cm - 11 3/4"



Lister

- CFS-04-772-14T 14 cm - 5 1/2"
- CFS-04-772-18T 18 cm - 7"
- CFS-04-772-20T 20 cm - 8"
- CFS-04-773-14S 14 cm - 5 1/2"
- CFS-04-773-18S 18 cm - 7"
- CFS-04-773-20S 20 cm - 8"



Lister - Modified

- CFS-04-774-18 18 cm - 7"
- CFS-04-774-20 20 cm - 8"
- CFS-04-775-20S 20 cm - 8"

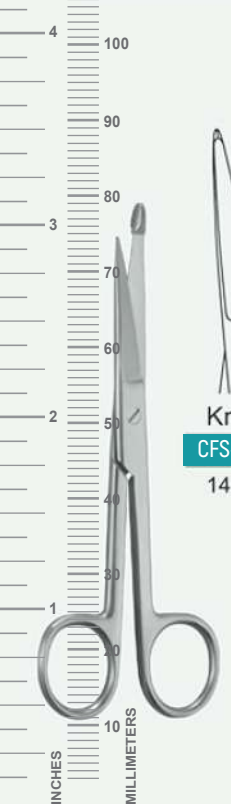

Knowles

- CFS-04-777-14 14 cm / 5 1/2"

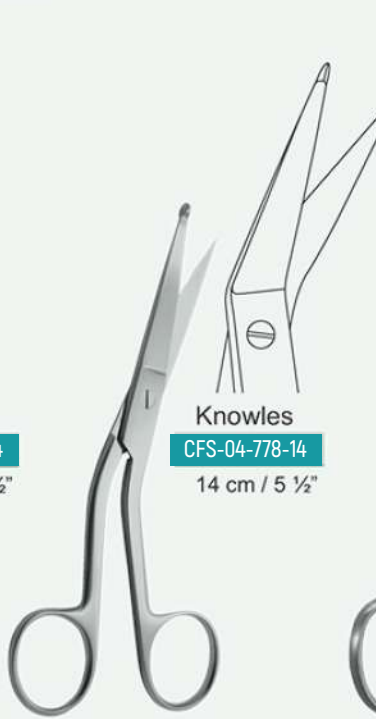

Knowles

- CFS-04-778-14 14 cm / 5 1/2"



Sharp - Modified

- CFS-04-779-16 16 cm / 6 1/4"



Smith (Mod. USA)

- CFS-04-780-16 16 cm / 6 1/4"
- CFS-04-780-18 18 cm / 7"
- CFS-04-780-20 20 cm / 8"
- CFS-04-780-23 23 cm / 9"

INCHES
MILLIMETERS



Lange
CFS-04-776-18
 18 cm / 7"

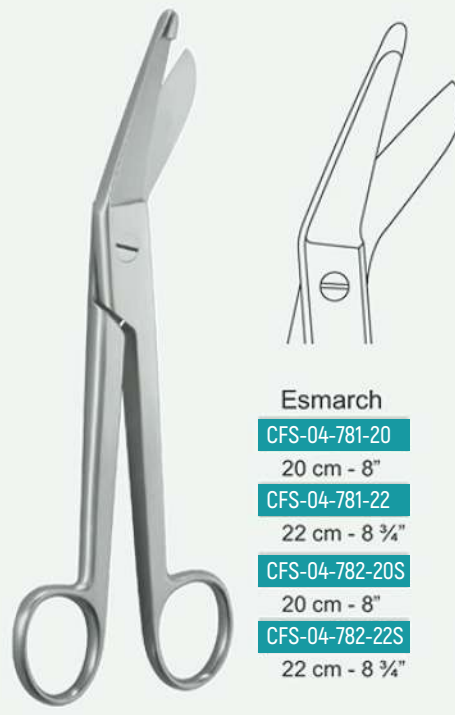

Esmarch
CFS-04-781-20
 20 cm - 8"
CFS-04-781-22
 22 cm - 8 3/4"
CFS-04-782-20S
 20 cm - 8"
CFS-04-782-22S
 22 cm - 8 3/4"

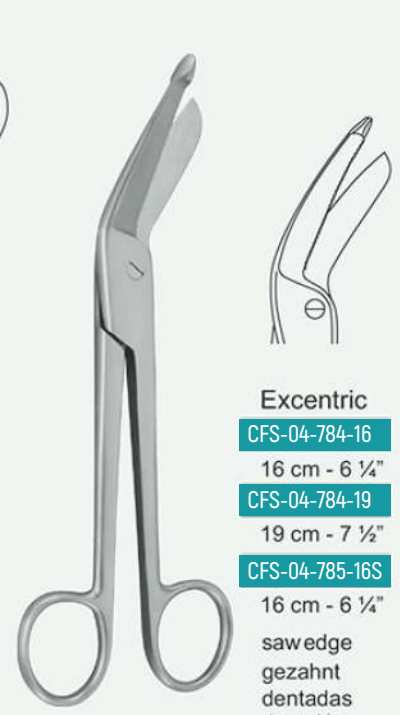

Excentric
CFS-04-784-16
 16 cm - 6 1/4"
CFS-04-784-19
 19 cm - 7 1/2"
CFS-04-785-16S
 16 cm - 6 1/4"
 sawedge
 gezahnt
 dentadas
 dentelés



Cremer
CFS-04-786-18
 18 cm - 7"



Bergmann
CFS-04-787-23
 23 cm - 9"

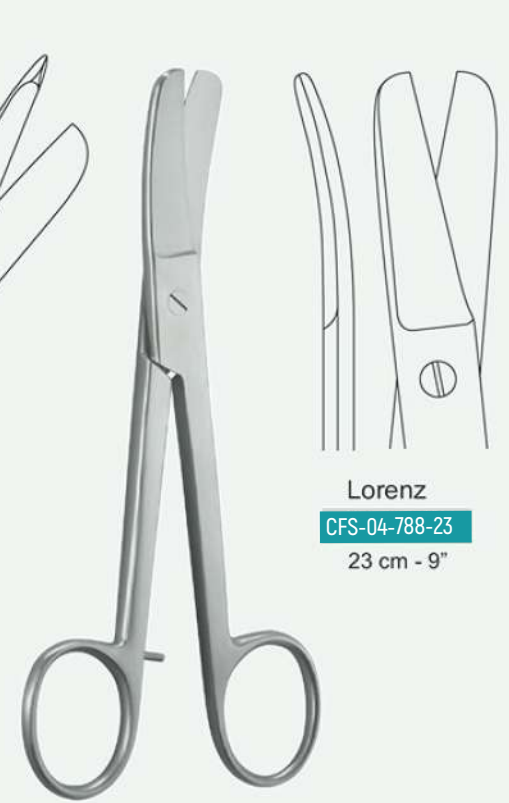

Lorenz
CFS-04-788-23
 23 cm - 9"



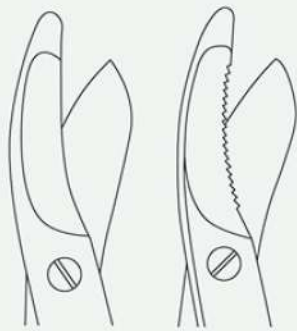

Brun's
CFS-04-789-24 24 cm - 9 1/2"
CFS-04-790-24 24 cm - 9 1/2"
 saw edge
 gezahnt
 dentadas
 dentelés

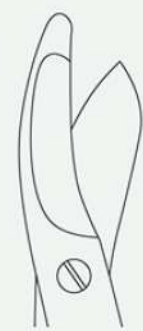
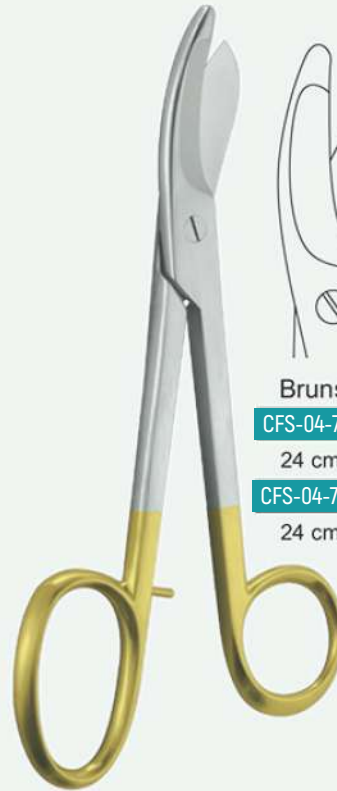

Brun's
CFS-04-791-24 24 cm - 9 1/2"
CFS-04-792-24S 24 cm - 9 1/2"

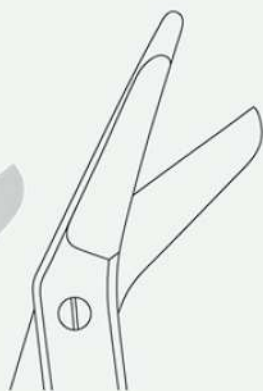

Western
CFS-04-793-20
 20 cm - 8"

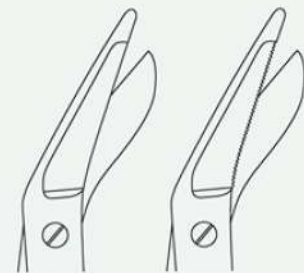

Seutin
CFS-04-794-23 23 cm - 9"
CFS-04-795-23 23 cm - 9"
 saw edge
 gezahnt
 dentadas
 dentelés



Plaster

CFS-04-796-23

23 cm - 9"



Wendy

CFS-04-797-22

22 cm - 8 ¾"



Collin

CFS-04-798-19

19 cm - 7 ½"



Gluck

CFS-04-799-19

19 cm - 7 ½"

CFS-04-800-22

22 cm - 8 ¾"



Stille

CFS-04-801-21

21 cm - 8 ¼"



Noyes

CFS-04-802-12

sharp – sharp
 spitz – spitz
 roma – roma
 pointue – pointue



CFS-04-803-12

sharp – blunt
 spitz – stumpf
 roma – aguda
 pointue – mousse



CFS-04-804-12

blunt – blunt
 stumpf – stumpf
 aguda – aguda
 mousse – mousse

12 cm - 4 3/4"

straight
 gerade
 recta
 droits



Noyes

CFS-04-805-12

sharp – sharp
 spitz – spitz
 roma – roma
 pointue – pointue



CFS-04-806-12

sharp – blunt
 spitz – stumpf
 roma – aguda
 pointue – mousse



CFS-04-807-12

blunt – blunt
 stumpf – stumpf
 aguda – aguda
 mousse – mousse

12 cm / 4 3/4"

angulated
 abgewinkelt
 angulado
 coudé





Vannas

CFS-04-808-12

12 cm - 4 ¾"



Wecker

CFS-04-809-12

sharp – blunt
 spitz – stumpf
 roma – aguda
 pointue – mousse



CFS-04-810-12

blunt – blunt
 stumpf – stumpf
 aguda – aguda
 mousse – mousse



CFS-04-811-12

sharp – sharp
 spitz – spitz
 roma – roma
 pointue – pointue



Barraquer

CFS-04-812-05

5.5 cm - 2 ¼"
 x = 0.7 cm

CFS-04-813-05

5.5 cm - 2 ¼"
 x = 1 cm



Westcott

CFS-04-814-11

11.5 cm - 4 ½"



CFS-04-815-11

11.5 cm - 4 ½"



Castroviejo

CFS-04-816-09

9 cm - 3 ½"

