

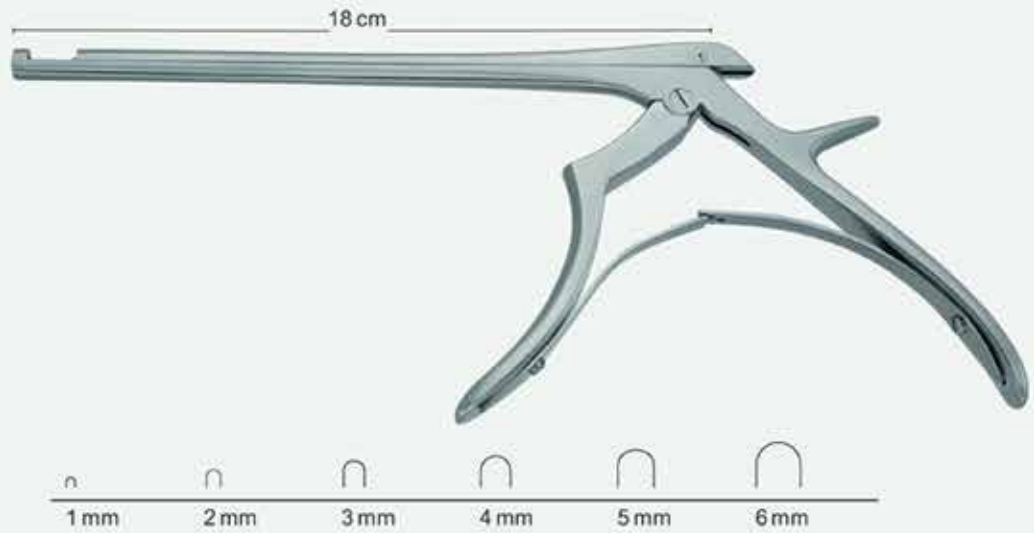

02

Micro Neurosurgery
Mikro Neurochirurgie
Micro Neurocirugia
Micro Neurochirurgie
Micro Neurochirurgia



Ferris- Smith-Kerrison



CFS-13-358-01	CFS-13-359-01	CFS-13-360-01	CFS-13-361-01	1 mm
CFS-13-358-02	CFS-13-359-02	CFS-13-360-02	CFS-13-361-02	2 mm
CFS-13-358-03	CFS-13-359-03	CFS-13-360-03	CFS-13-361-03	3 mm
CFS-13-358-04	CFS-13-359-04	CFS-13-360-04	CFS-13-361-04	4 mm
CFS-13-358-05	CFS-13-359-05	CFS-13-360-05	CFS-13-361-05	5 mm
CFS-13-358-06	CFS-13-359-06	CFS-13-360-06	CFS-13-361-06	6 mm
CFS-13-362-01	CFS-13-363-01	CFS-13-364-01	CFS-13-365-01	1 mm
CFS-13-362-02	CFS-13-363-02	CFS-13-364-02	CFS-13-365-02	2 mm
CFS-13-362-03	CFS-13-363-03	CFS-13-364-03	CFS-13-365-03	3 mm
CFS-13-362-04	CFS-13-363-04	CFS-13-364-04	CFS-13-365-04	4 mm
CFS-13-362-05	CFS-13-363-05	CFS-13-364-05	CFS-13-365-05	5 mm
CFS-13-362-06	CFS-13-363-06	CFS-13-364-06	CFS-13-365-06	6 mm
CFS-13-366-01	CFS-13-367-01	CFS-13-368-01	CFS-13-369-01	1 mm
CFS-13-366-02	CFS-13-367-02	CFS-13-368-02	CFS-13-369-02	2 mm
CFS-13-366-03	CFS-13-367-03	CFS-13-368-03	CFS-13-369-03	3 mm
CFS-13-366-04	CFS-13-367-04	CFS-13-368-04	CFS-13-369-04	4 mm
CFS-13-366-05	CFS-13-367-05	CFS-13-368-05	CFS-13-369-05	5 mm
CFS-13-366-06	CFS-13-367-06	CFS-13-368-06	CFS-13-369-06	6 mm
CFS-13-369-20	CFS-13-370-19	CFS-13-371-11	CFS-13-371-01	1 mm
CFS-13-369-21	CFS-13-370-20	CFS-13-371-22	CFS-13-371-02	2 mm
CFS-13-369-22	CFS-13-370-21	CFS-13-371-33	CFS-13-371-03	3 mm
CFS-13-369-23	CFS-13-370-22	CFS-13-371-44	CFS-13-371-04	4 mm
CFS-13-369-24	CFS-13-370-23	CFS-13-371-55	CFS-13-371-05	5 mm
CFS-13-369-25	CFS-13-370-24	CFS-13-371-66	CFS-13-371-06	6 mm

x = 15 cm - 6" x = 18 cm - 7" x = 20 cm - 8" x = 23 cm - 9"



add "B" with catalogue part number if required in black TIN coating
add "E" with catalogue part number if required with ejector

INCHES
MILLIMETERS



Ferris- Smith-Kerrison (Detachable)



Thin footplate
Dünne Fußplatte
Lámina de punzonar estrecha
Plaque de coupe étroite
Battente sottile

CFS-13-372-01	CFS-13-372-07	CFS-13-373-01	1 mm
CFS-13-372-02	CFS-13-372-08	CFS-13-373-02	2 mm
CFS-13-372-03	CFS-13-372-09	CFS-13-373-03	3 mm
CFS-13-372-04	CFS-13-372-10	CFS-13-373-04	4 mm
CFS-13-372-05	CFS-13-372-11	CFS-13-373-05	5 mm
CFS-13-372-06	CFS-13-372-12	CFS-13-373-06	6 mm
CFS-13-374-01	CFS-13-374-07	CFS-13-375-01	1 mm
CFS-13-374-02	CFS-13-374-08	CFS-13-375-02	2 mm
CFS-13-374-03	CFS-13-374-09	CFS-13-375-03	3 mm
CFS-13-374-04	CFS-13-374-10	CFS-13-375-04	4 mm
CFS-13-374-05	CFS-13-374-11	CFS-13-375-05	5 mm
CFS-13-374-06	CFS-13-374-12	CFS-13-375-06	6 mm
CFS-13-376-01	CFS-13-376-13	CFS-13-377-01	1 mm
CFS-13-376-02	CFS-13-376-14	CFS-13-377-02	2 mm
CFS-13-376-03	CFS-13-376-15	CFS-13-377-03	3 mm
CFS-13-376-04	CFS-13-376-16	CFS-13-377-04	4 mm
CFS-13-376-05	CFS-13-376-17	CFS-13-377-05	5 mm
CFS-13-376-06	CFS-13-376-18	CFS-13-377-06	6 mm
CFS-13-376-07	CFS-13-376-19	CFS-13-377-11	1 mm
CFS-13-376-08	CFS-13-376-20	CFS-13-377-12	2 mm
CFS-13-376-09	CFS-13-376-21	CFS-13-377-07	3 mm
CFS-13-376-10	CFS-13-376-22	CFS-13-377-08	4 mm
CFS-13-376-11	CFS-13-376-23	CFS-13-377-09	5 mm
CFS-13-376-12	CFS-13-376-24	CFS-13-377-10	6 mm

x = 18 cm - 7"

x = 20 cm - 8"

x = 23 cm - 9"



add "B" with catalogue part number if required in black TiN coating
add "E" with catalogue part number if required with ejector



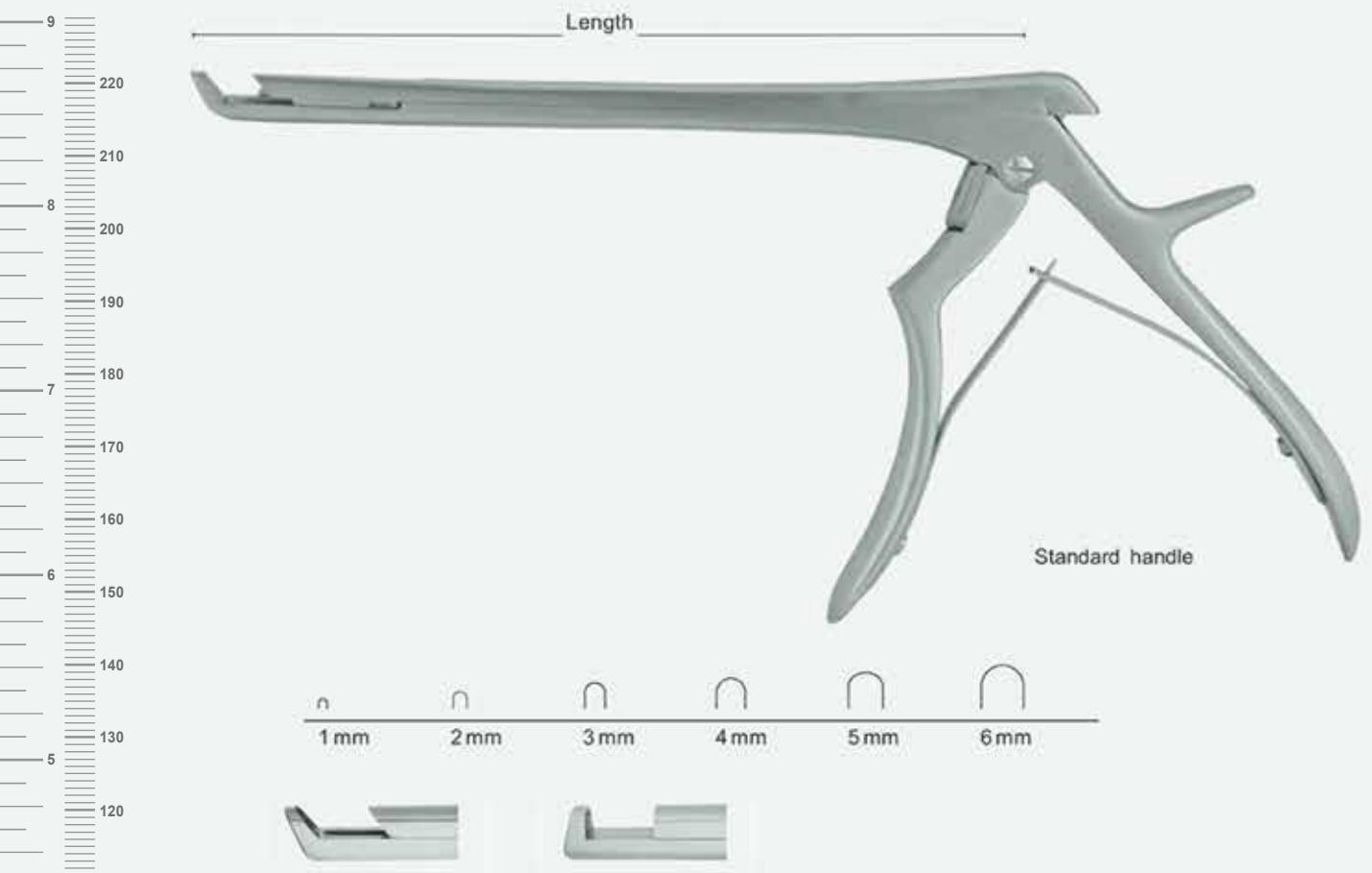

Ferris- Smith-Kerrison

Fig. 1

CFS-13-677-01
CFS-13-678-01
CFS-13-677-02
CFS-13-678-02
CFS-13-677-03
CFS-13-678-03
CFS-13-677-04
CFS-13-678-04
CFS-13-677-05
CFS-13-678-05
CFS-13-677-06
CFS-13-678-06

Upwards cutting 40°

Fig. 2

	Length
CFS-13-679-01	1 mm 18 cm / 7"
CFS-13-680-01	1 mm 23 cm / 9"
CFS-13-679-02	2 mm 18 cm / 7"
CFS-13-680-02	2 mm 23 cm / 9"
CFS-13-679-03	3 mm 18 cm / 7"
CFS-13-680-03	3 mm 23 cm / 9"
CFS-13-679-04	4 mm 18 cm / 7"
CFS-13-680-04	4 mm 23 cm / 9"
CFS-13-679-05	5 mm 18 cm / 7"
CFS-13-680-05	5 mm 23 cm / 9"
CFS-13-679-06	6 mm 18 cm / 7"
CFS-13-680-06	6 mm 23 cm / 9"

Upwards cutting 90°



add "B" with catalogue part number if required in black TIN coating
add "E" with catalogue part number if required with ejector

INCHES
MILLIMETERS

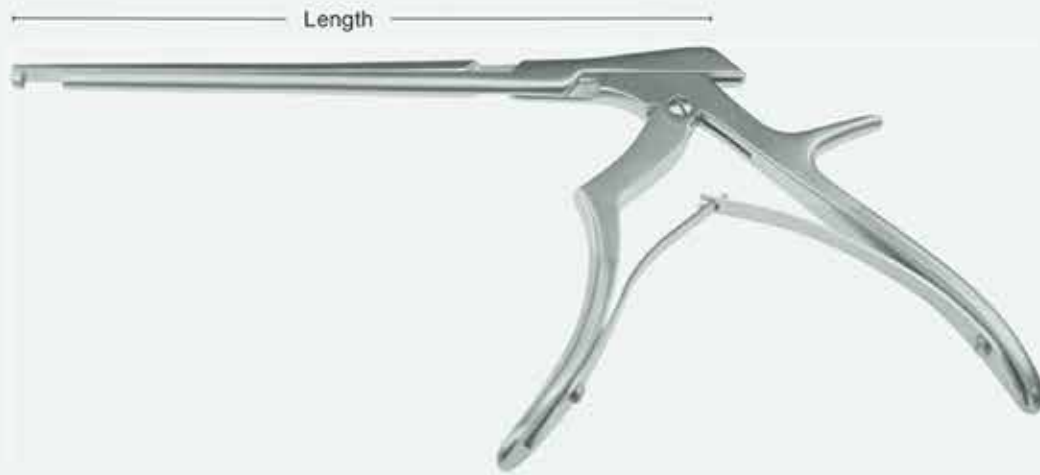

Standard handle

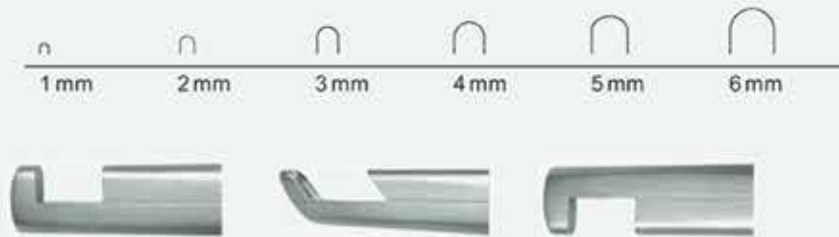

Love - Kerrison

Fig. 1

CFS-13-681-01
CFS-13-681-02
CFS-13-681-03
CFS-13-681-04
CFS-13-681-05
CFS-13-681-06
CFS-13-682-01
CFS-13-682-02
CFS-13-682-03
CFS-13-682-04
CFS-13-682-05
CFS-13-682-06

Upwards cutting 90°

Fig. 2

CFS-13-683-01
CFS-13-683-02
CFS-13-683-03
CFS-13-683-04
CFS-13-683-05
CFS-13-683-06
CFS-13-684-01
CFS-13-684-02
CFS-13-684-03
CFS-13-684-04
CFS-13-684-05
CFS-13-684-06

Upwards cutting 40°

Fig. 3

	Length
CFS-13-685-01	1 mm 18 cm / 7"
CFS-13-685-02	2 mm 18 cm / 7"
CFS-13-685-03	3 mm 18 cm / 7"
CFS-13-685-04	4 mm 18 cm / 7"
CFS-13-685-05	5 mm 18 cm / 7"
CFS-13-685-06	6 mm 18 cm / 7"
CFS-13-686-01	1 mm 20 cm / 8"
CFS-13-686-02	2 mm 20 cm / 8"
CFS-13-686-03	3 mm 20 cm / 8"
CFS-13-686-04	4 mm 20 cm / 8"
CFS-13-686-05	5 mm 20 cm / 8"
CFS-13-686-06	6 mm 20 cm / 8"

Upwards cutting 90°

add "B" with catalogue part number if required in black TiN coating
add "E" with catalogue part number if required with ejector



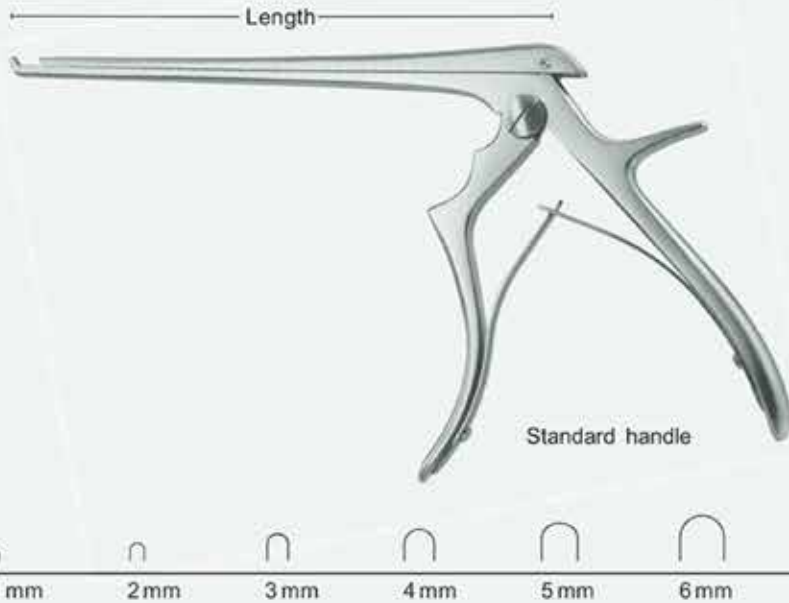

Kerrison
Fig. 1

Fig. 2

Fig. 3

Fig. 4

Length

CFS-13-723-02	CFS-13-727-02	CFS-13-731-02	CFS-13-002-02	2 mm	15 cm / 6"
CFS-13-723-03	CFS-13-727-03	CFS-13-731-03	CFS-13-002-03	3 mm	15 cm / 6"
CFS-13-723-04	CFS-13-727-04	CFS-13-731-04	CFS-13-002-04	4 mm	15 cm / 6"
CFS-13-723-05	CFS-13-727-05	CFS-13-731-05	CFS-13-002-05	5 mm	15 cm / 6"
CFS-13-724-01	CFS-13-728-01	CFS-13-732-01	CFS-13-003-01	1 mm	18 cm / 7"
CFS-13-724-02	CFS-13-728-02	CFS-13-732-02	CFS-13-003-02	2 mm	18 cm / 7"
CFS-13-724-03	CFS-13-728-03	CFS-13-732-03	CFS-13-003-03	3 mm	18 cm / 7"
CFS-13-724-04	CFS-13-728-04	CFS-13-732-04	CFS-13-003-04	4 mm	18 cm / 7"
CFS-13-724-05	CFS-13-728-05	CFS-13-732-05	CFS-13-003-05	5 mm	18 cm / 7"
CFS-13-725-02	CFS-13-729-02	CFS-13-733-02	CFS-13-004-02	2 mm	20 cm / 8"
CFS-13-725-03	CFS-13-729-03	CFS-13-733-03	CFS-13-004-03	3 mm	20 cm / 8"
CFS-13-725-04	CFS-13-729-04	CFS-13-733-04	CFS-13-004-04	4 mm	20 cm / 8"
CFS-13-725-05	CFS-13-729-05	CFS-13-733-05	CFS-13-004-05	5 mm	20 cm / 8"
CFS-13-726-02	CFS-13-730-02	CFS-13-001-02	CFS-13-005-02	2 mm	23 cm / 9"
CFS-13-726-03	CFS-13-730-03	CFS-13-001-03	CFS-13-005-03	3 mm	23 cm / 9"
CFS-13-726-04	CFS-13-730-04	CFS-13-001-04	CFS-13-005-04	4 mm	23 cm / 9"
CFS-13-726-05	CFS-13-730-05	CFS-13-001-05	CFS-13-005-05	5 mm	23 cm / 9"

Upwards cutting 90°
Thin footplate

Upwards cutting 40°
Thin footplate

Downwards cutting 90°
Thin footplate

Downwards cutting 40°
Thin footplate



add "B" with catalogue part number if required in black TIN coating
add "E" with catalogue part number if required with ejector

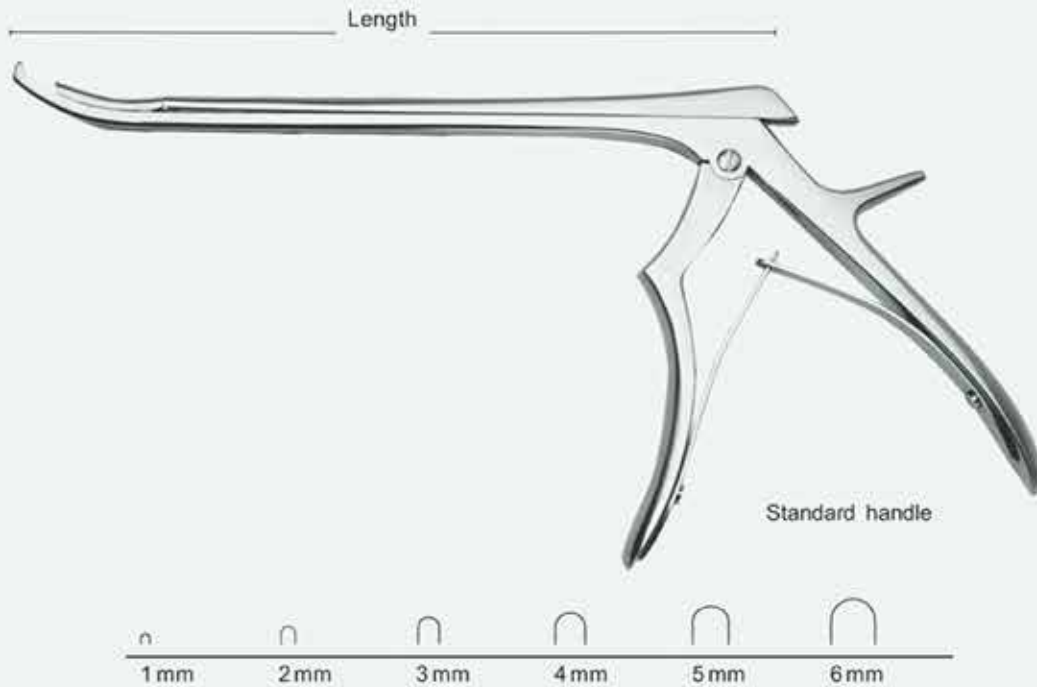

Fig. 1

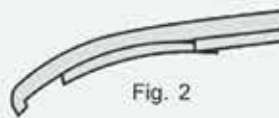

Fig. 2

Kerrison
Fig. 1

	Fig. 2	Length
CFS-13-735-01	CFS-13-738-01	1 mm 18 cm / 7"
CFS-13-736-01	CFS-13-739-01	1 mm 20 cm / 8"
CFS-13-737-01	CFS-13-740-01	1 mm 23 cm / 9"
CFS-13-735-02	CFS-13-738-02	2 mm 18 cm / 7"
CFS-13-736-02	CFS-13-739-02	2 mm 20 cm / 8"
CFS-13-737-02	CFS-13-740-02	2 mm 23 cm / 9"
CFS-13-735-03	CFS-13-738-03	3 mm 18 cm / 7"
CFS-13-736-03	CFS-13-739-03	3 mm 20 cm / 8"
CFS-13-737-03	CFS-13-740-03	3 mm 23 cm / 9"
CFS-13-735-04	CFS-13-738-04	4 mm 18 cm / 7"
CFS-13-736-04	CFS-13-739-04	4 mm 20 cm / 8"
CFS-13-737-04	CFS-13-740-04	4 mm 23 cm / 9"
CFS-13-735-05	CFS-13-738-05	5 mm 18 cm / 7"
CFS-13-736-05	CFS-13-739-05	5 mm 20 cm / 8"
CFS-13-737-05	CFS-13-740-05	5 mm 23 cm / 9"
CFS-13-735-06	CFS-13-738-06	6 mm 18 cm / 7"
CFS-13-736-06	CFS-13-739-06	6 mm 20 cm / 8"
CFS-13-737-06	CFS-13-740-06	6 mm 23 cm / 9"

Upwards cutting 40°

Downwards cutting 40°

Kerrison
Fig. 1

	Fig. 2	Length
CFS-13-741-01	CFS-13-744-01	1 mm 18 cm / 7"
CFS-13-742-01	CFS-13-745-01	1 mm 20 cm / 8"
CFS-13-743-01	CFS-13-746-01	1 mm 23 cm / 9"
CFS-13-741-02	CFS-13-744-02	2 mm 18 cm / 7"
CFS-13-742-02	CFS-13-745-02	2 mm 20 cm / 8"
CFS-13-743-02	CFS-13-746-02	2 mm 23 cm / 9"
CFS-13-741-03	CFS-13-744-03	3 mm 18 cm / 7"
CFS-13-742-03	CFS-13-745-03	3 mm 20 cm / 8"
CFS-13-743-03	CFS-13-746-03	3 mm 23 cm / 9"
CFS-13-741-04	CFS-13-744-04	4 mm 18 cm / 7"
CFS-13-742-04	CFS-13-745-04	4 mm 20 cm / 8"
CFS-13-743-04	CFS-13-746-04	4 mm 23 cm / 9"
CFS-13-741-05	CFS-13-744-05	5 mm 18 cm / 7"
CFS-13-742-05	CFS-13-745-05	5 mm 20 cm / 8"
CFS-13-743-05	CFS-13-746-05	5 mm 23 cm / 9"
CFS-13-741-06	CFS-13-744-06	6 mm 18 cm / 7"
CFS-13-742-06	CFS-13-745-06	6 mm 20 cm / 8"
CFS-13-743-06	CFS-13-746-06	6 mm 23 cm / 9"

Upwards cutting 40°
Bayonet

Downwards cutting 40°
Bayonet

i add "B" with catalogue part number if required in black TiN coating
add "E" with catalogue part number if required with ejector



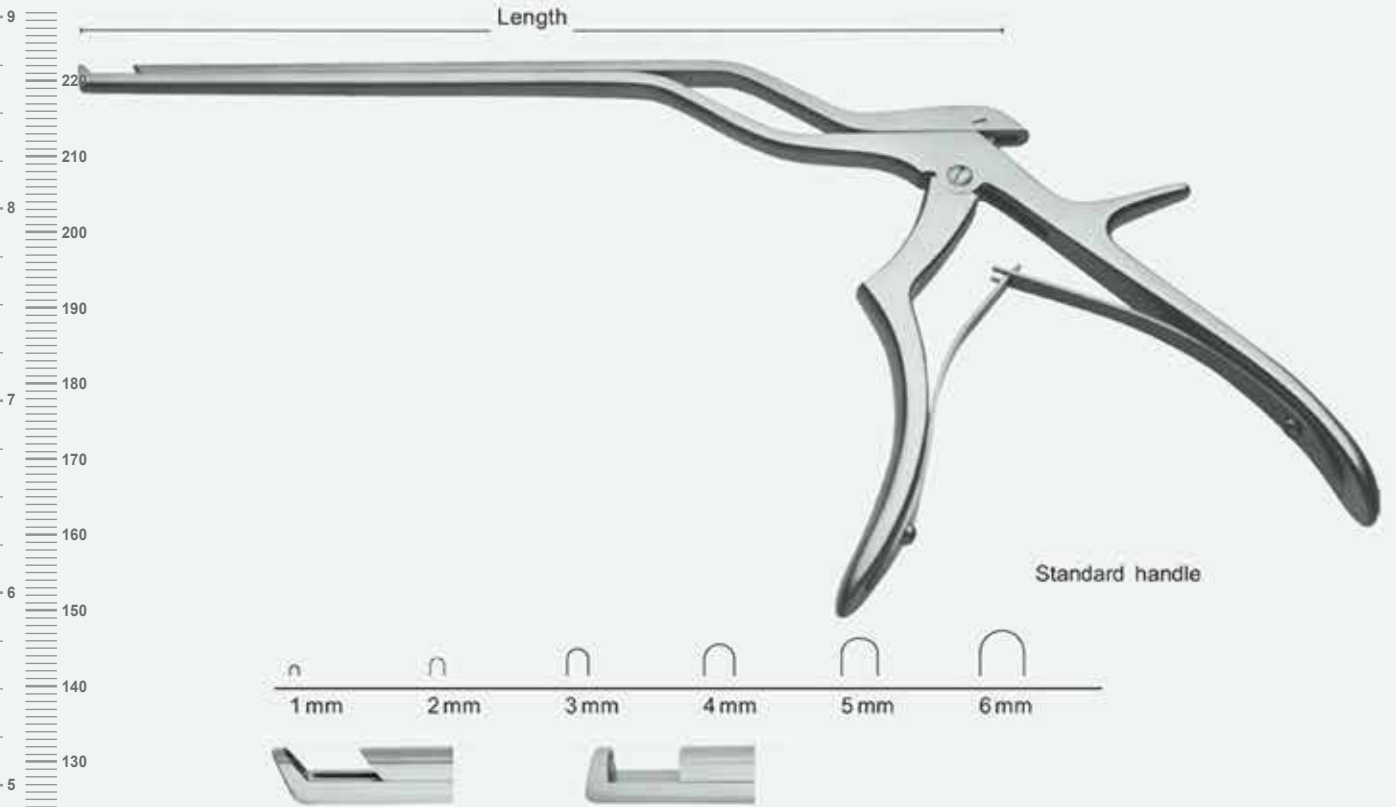

Kerrison
Fig. 1

CFS-13-447-01
CFS-13-448-01
CFS-13-449-01
CFS-13-447-02
CFS-13-448-02
CFS-13-449-02
CFS-13-447-03
CFS-13-448-03
CFS-13-449-03
CFS-13-447-04
CFS-13-448-04
CFS-13-449-04
CFS-13-447-05
CFS-13-448-05
CFS-13-449-05
CFS-13-447-06
CFS-13-448-06
CFS-13-449-06

Upwards cutting 40°

Fig. 2

	Length
CFS-13-450-01	1 mm 11 cm / 4 1/4"
CFS-13-451-01	1 mm 15 cm / 6"
CFS-13-452-01	1 mm 18 cm / 7"
CFS-13-450-02	2 mm 11 cm / 4 1/4"
CFS-13-451-02	2 mm 15 cm / 6"
CFS-13-452-02	2 mm 18 cm / 7"
CFS-13-450-03	3 mm 11 cm / 4 1/4"
CFS-13-451-03	3 mm 15 cm / 6"
CFS-13-452-03	3 mm 18 cm / 7"
CFS-13-450-04	4 mm 11 cm / 4 1/4"
CFS-13-451-04	4 mm 15 cm / 6"
CFS-13-452-04	4 mm 18 cm / 7"
CFS-13-450-05	5 mm 11 cm / 4 1/4"
CFS-13-451-05	5 mm 15 cm / 6"
CFS-13-452-05	5 mm 18 cm / 7"
CFS-13-450-06	6 mm 11 cm / 4 1/4"
CFS-13-451-06	6 mm 15 cm / 6"
CFS-13-452-06	6 mm 18 cm / 7"

Upwards cutting 90°



add "B" with catalogue part number if required in black TIN coating
add "E" with catalogue part number if required with ejector



Kerrison
Fig. 1

CFS-13-453-01
CFS-13-454-01
CFS-13-455-01
CFS-13-453-02
CFS-13-454-02
CFS-13-454-02
CFS-13-453-03
CFS-13-454-03
CFS-13-455-03
CFS-13-453-04
CFS-13-454-04
CFS-13-455-04
CFS-13-453-05
CFS-13-454-05
CFS-13-455-05
CFS-13-453-06
CFS-13-454-06
CFS-13-455-06

Upwards cutting 40°
Bayonet left

Fig. 2

CFS-13-456-01
CFS-13-457-01
CFS-13-458-01
CFS-13-456-02
CFS-13-457-02
CFS-13-458-02
CFS-13-456-03
CFS-13-457-03
CFS-13-458-03
CFS-13-456-04
CFS-13-457-04
CFS-13-458-04
CFS-13-456-05
CFS-13-457-05
CFS-13-458-05
CFS-13-456-06
CFS-13-457-06
CFS-13-458-06

Upwards cutting 90°
Bayonet left

Fig. 3

CFS-13-459-01
CFS-13-460-01
CFS-13-461-01
CFS-13-459-02
CFS-13-460-02
CFS-13-461-02
CFS-13-459-03
CFS-13-460-03
CFS-13-461-03
CFS-13-459-04
CFS-13-460-04
CFS-13-461-04
CFS-13-459-05
CFS-13-460-05
CFS-13-461-05
CFS-13-459-06
CFS-13-460-06
CFS-13-461-06

Upwards cutting 40°
Bayonet right

Fig. 4

		Length
CFS-13-462-01	1 mm	11 cm / 4 1/4"
CFS-13-463-01	1 mm	15 cm / 6"
CFS-13-464-01	1 mm	18 cm / 7"
CFS-13-462-02	2 mm	11 cm / 4 1/4"
CFS-13-463-02	2 mm	15 cm / 6"
CFS-13-464-02	2 mm	18 cm / 7"
CFS-13-462-03	3 mm	11 cm / 4 1/4"
CFS-13-463-03	3 mm	15 cm / 6"
CFS-13-464-03	3 mm	18 cm / 7"
CFS-13-462-04	4 mm	11 cm / 4 1/4"
CFS-13-463-04	4 mm	15 cm / 6"
CFS-13-464-04	4 mm	18 cm / 7"
CFS-13-462-05	5 mm	11 cm / 4 1/4"
CFS-13-463-05	5 mm	15 cm / 6"
CFS-13-464-05	5 mm	18 cm / 7"
CFS-13-462-06	6 mm	11 cm / 4 1/4"
CFS-13-463-06	6 mm	15 cm / 6"
CFS-13-464-06	6 mm	18 cm / 7"

Upwards cutting 90°
Bayonet right



add "B" with catalogue part number if required in black TIN coating
add "E" with catalogue part number if required with ejector



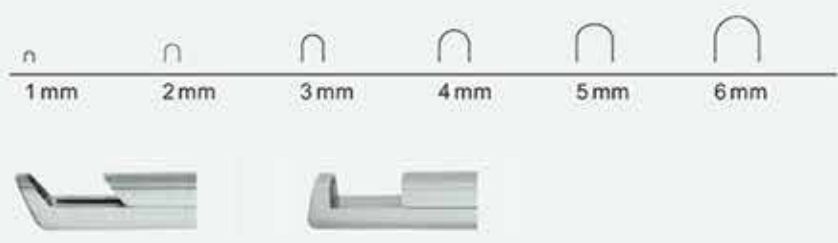
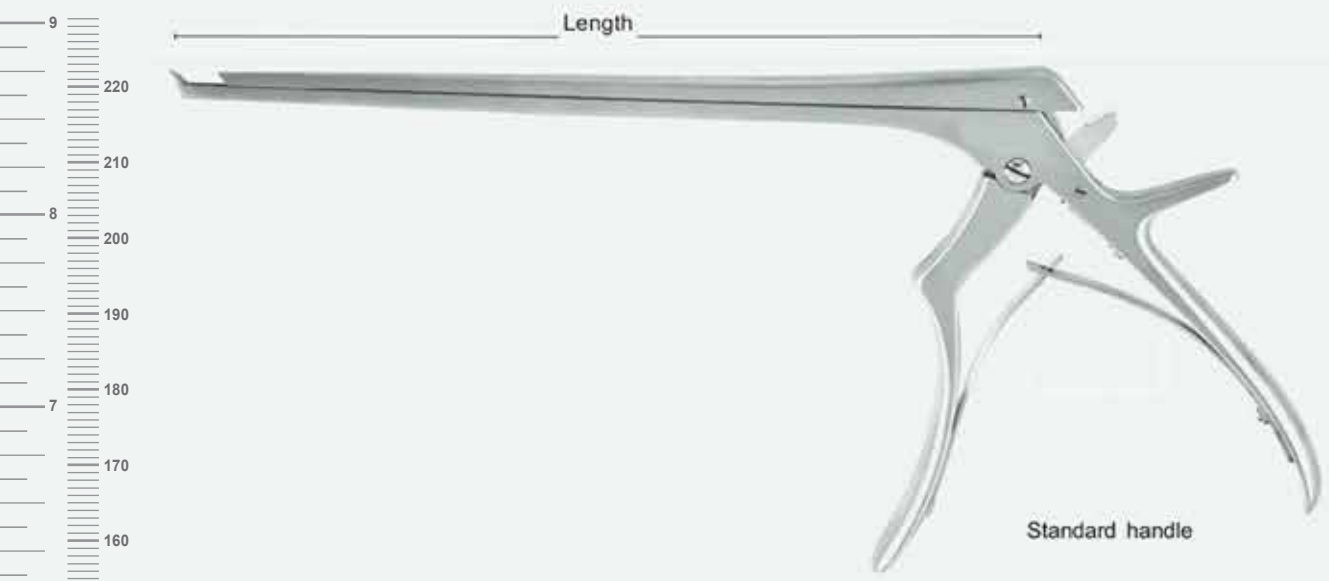

Kerrison Detachable

Fig. 1

CFS-13-765-01
CFS-13-766-01
CFS-13-765-02
CFS-13-766-02
CFS-13-765-03
CFS-13-766-03
CFS-13-765-04
CFS-13-766-04
CFS-13-765-05
CFS-13-766-05
CFS-13-765-06
CFS-13-766-06

Upwards cutting 40°

Fig. 2

	Length
CFS-13-767-01	1 mm 18 cm / 7"
CFS-13-768-01	1 mm 23 cm / 9"
CFS-13-767-02	2 mm 18 cm / 7"
CFS-13-768-02	2 mm 23 cm / 9"
CFS-13-767-03	3 mm 18 cm / 7"
CFS-13-768-03	3 mm 23 cm / 9"
CFS-13-767-04	4 mm 18 cm / 7"
CFS-13-768-04	4 mm 23 cm / 9"
CFS-13-767-05	5 mm 18 cm / 7"
CFS-13-768-05	5 mm 23 cm / 9"
CFS-13-767-06	6 mm 18 cm / 7"
CFS-13-768-06	6 mm 23 cm / 9"

Upwards cutting 90°



add "B" with catalogue part number if required in black TIN coating
add "E" with catalogue part number if required with ejector

INCHES
MILLIMETERS

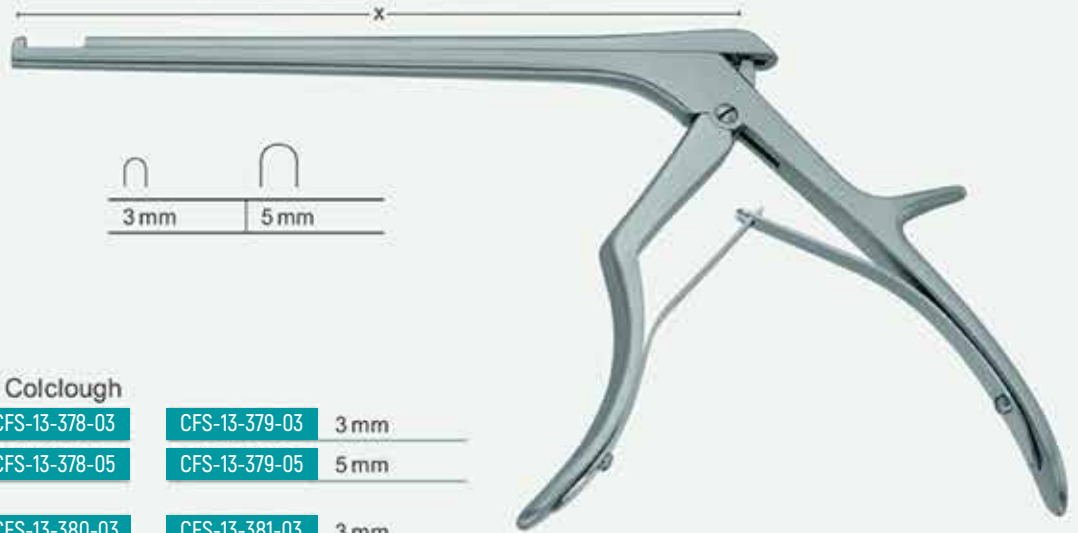

Colclough

	CFS-13-378-03	CFS-13-379-03	3 mm
	CFS-13-378-05	CFS-13-379-05	5 mm
	CFS-13-380-03	CFS-13-381-03	3 mm
	CFS-13-380-05	CFS-13-381-05	5 mm
	CFS-13-382-03	CFS-13-383-03	3 mm
	CFS-13-382-05	CFS-13-383-05	5 mm
	x = 15 cm - 6"		x = 20 cm - 8"

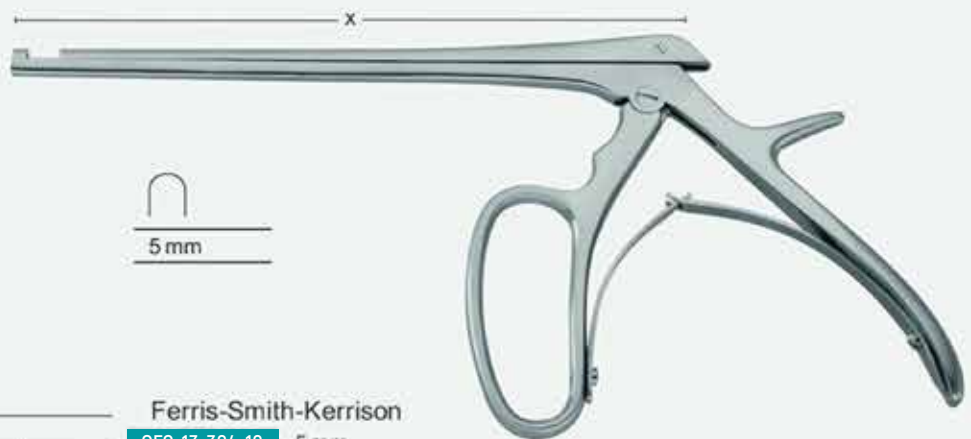

	Ferris-Smith-Kerrison	
	CFS-13-384-18	5 mm
	CFS-13-385-18	5 mm
	x = 18 cm - 7"	

i add "B" with catalogue part number if required in black TiN coating
 add "E" with catalogue part number if required with ejector







Tip Type	Model	Tip Size	Length (x)		
Cushing	CFS-13-386-13	2 mm x 10 mm	x = 13 cm - 5"		
	CFS-13-386-18		x = 18 cm - 7"		
	CFS-13-386-22		x = 22 cm - 8 3/4"		
	Love-Gruenwald	CFS-13-387-13	2 mm x 10 mm	x = 13 cm - 5"	
		CFS-13-387-18		x = 18 cm - 7"	
		CFS-13-387-22		x = 22 cm - 8 3/4"	
		Spurling	CFS-13-388-13	2 mm x 10 mm	x = 13 cm - 5"
			CFS-13-388-18		x = 18 cm - 7"
			CFS-13-388-22		x = 22 cm - 8 3/4"
Love-Gruenwald			CFS-13-389-13	3 mm x 10 mm	x = 13 cm - 5"
			CFS-13-389-18		x = 18 cm - 7"
			CFS-13-389-22		x = 22 cm - 8 3/4"
	Spurling		CFS-13-390-13	3 mm x 10 mm	x = 13 cm - 5"
			CFS-13-390-18		x = 18 cm - 7"
			CFS-13-390-22		x = 22 cm - 8 3/4"
		Spurling	CFS-13-391-13	3 mm x 10 mm	x = 13 cm - 5"
			CFS-13-391-18		x = 18 cm - 7"
			CFS-13-391-22		x = 22 cm - 8 3/4"
Spurling			CFS-13-392-13	4 mm x 10 mm	x = 13 cm - 5"
			CFS-13-392-18		x = 18 cm - 7"
			CFS-13-392-22		x = 22 cm - 8 3/4"
	Cloward		CFS-13-393-13	4 mm x 10 mm	x = 13 cm - 5"
			CFS-13-393-18		x = 18 cm - 7"
	Cloward		CFS-13-394-13	4 mm x 10 mm	x = 13 cm - 5"
		CFS-13-394-18	x = 18 cm - 7"		
	Cloward	CFS-13-394-22	4 mm x 10 mm	x = 22 cm - 8 3/4"	
		CFS-13-395-18		6 mm x 10 mm	x = 18 cm - 7"





Ferris-Smith

	CFS-13-396-02	CFS-13-397-02	CFS-13-398-02 2 mm x 10 mm
	CFS-13-396-03	CFS-13-397-03	CFS-13-398-03 3 mm x 10 mm
	CFS-13-396-04	CFS-13-397-04	CFS-13-398-04 4 mm x 10 mm
	CFS-13-396-06	CFS-13-397-06	CFS-13-398-06 6 mm x 10 mm
	x = 18 cm - 7"	x = 18 cm - 7"	x = 18 cm - 7"

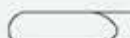

Caspar

	CFS-13-399-02	CFS-13-400-02	CFS-13-401-02 2 mm
	CFS-13-399-03	CFS-13-400-03	CFS-13-401-03 3 mm
	CFS-13-399-04	CFS-13-400-04	CFS-13-401-04 4 mm
	CFS-13-399-05	CFS-13-400-05	CFS-13-401-05 5 mm
	x = 15.5 cm - 6"	x = 15.5 cm - 6"	x = 15.5 cm - 6"





Oldenberg

CFS-13-402-17 **CFS-13-403-17** **17 cm - 6 3/4"**

3.5 mm Ø 6.0 mm Ø
x = 180 mm - 7" x = 180 mm - 7"



Schlesinger

CFS-13-404-19 **19 cm - 7 1/2"**

CFS-13-404-21 **21.5 cm - 8 1/2"**

3 mm x 10 mm
x = 125 mm - 5"

saw edge
gezahnt
dentada
dentelé
dentata





Caspar

CFS-13-405-02
CFS-13-405-03
CFS-13-405-04
CFS-13-405-05
CFS-13-405-06

x = 14 cm - 5 1/2"

CFS-13-406-02
CFS-13-406-03
CFS-13-405-04
CFS-13-406-05
CFS-13-406-06

x = 16 cm - 6 1/4"

CFS-13-407-02	2 mm x 12 mm
CFS-13-407-03	3 mm x 12 mm
CFS-13-407-04	4 mm x 14 mm
CFS-13-407-05	5 mm x 14 mm
CFS-13-407-06	6 mm x 16 mm

x = 18.5 cm - 7 1/4"



CFS-13-408-02
CFS-13-408-04
CFS-13-408-05
CFS-13-408-06

x = 14 cm - 5 1/2"

CFS-13-409-02
CFS-13-409-04
CFS-13-409-05
CFS-13-409-06

x = 16 cm - 6 1/4"

CFS-13-410-02	2 mm x 12 mm
CFS-13-410-04	4 mm x 14 mm
CFS-13-410-05	5 mm x 14 mm
CFS-13-410-06	6 mm x 16 mm

x = 18.5 cm - 7 1/4"



CFS-13-411-05
CFS-13-411-06

x = 14 cm - 5 1/2"

CFS-13-412-05
CFS-13-412-06

x = 16 cm - 6 1/4"

CFS-13-413-05	5 mm x 14 mm
CFS-13-413-06	6 mm x 16 mm

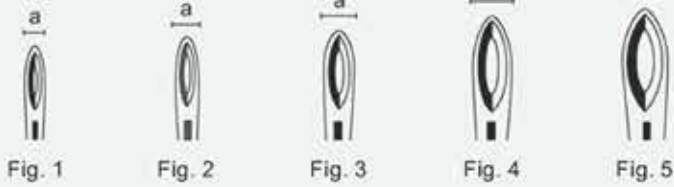

x = 18.5 cm - 7 1/4"

Jaw fenestrated and serrated
Maul gefenstert und gezahnt
Boca con orificio y dentada
Mors fenêtré et dentelé
Morso finestrato e dentellato



Weil-Blakesley

	CFS-18-288-12 a = 3.0mm	CFS-18-289-12 a = 3.5mm	CFS-18-290-12 a = 4.5mm	CFS-18-291-12 a = 5.0mm	CFS-18-292-12 a = 5.5mm	x = 12 cm - 4 3/4"
	CFS-18-293-12 a = 3.0mm	CFS-18-294-12 a = 3.5mm	CFS-18-295-12 a = 4.5mm	CFS-18-296-12 a = 5.0mm		
	CFS-18-297-12 a = 3.0mm	CFS-18-298-12 a = 3.5mm	CFS-18-299-12 a = 4.5mm			

	Fig. 1 CFS-18-300-18 a = 3.0mm	Fig. 2 CFS-18-301-18 a = 3.5mm	Fig. 3 CFS-18-302-18 a = 4.5mm	Fig. 4 CFS-18-303-18 a = 5.0mm	Fig. 5 CFS-18-304-18 a = 5.5mm	x = 18 cm - 7"
	CFS-18-305-18 a = 3.0mm	CFS-18-306-18 a = 3.5mm	CFS-18-307-18 a = 4.5mm	CFS-18-308-18 a = 5.0mm		x = 18 cm - 7"



Cloward

CFS-08-160-16	Retractor only	16 cm - 6 1/4"
CFS-08-160-00	Complete set consisting of:	
	1 Retractor	
	1 pair of blades 08-164-01 to 08-164-05	



CFS-08-161-25	Retractor only	25 cm - 9 3/4"
CFS-08-161-00	Complete set consisting of:	
	1 Retractor	
	1 pair of blades 08-164-01 to 08-164-05	



CFS-08-164-01	Fig.1	x = 60 mm
CFS-08-164-02	Fig.2	x = 55 mm
CFS-08-164-03	Fig.3	x = 50 mm
CFS-08-164-04	Fig.4	x = 45 mm
CFS-08-164-05	Fig.5	x = 40 mm

Non toothed
Nicht gezahnt
No dentada
Non denté
Non dentato



CFS-08-165-01	Fig.1	x = 60 mm
CFS-08-165-02	Fig.2	x = 55 mm
CFS-08-165-03	Fig.3	x = 50 mm
CFS-08-165-04	Fig.4	x = 45 mm
CFS-08-165-05	Fig.5	x = 40 mm

Toothed
Gezahnt
Dentada
Dentelée
Dentata



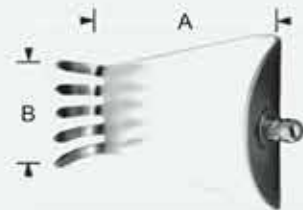

Cloward - Hoen

CFS-13-867-25	Retractor only	25 cm - 10"
CFS-13-867-00	Complete set consisting of:	
CFS-13-867-25	1 Retractor	
	1 pair of blades 13-858-50 to 13-868-64	

Cloward - Hoen	A	B
CFS-13-868-50		50x31mm
CFS-13-868-64		64x31mm



Caspar
 Fig. 1

CFS-13-878-01	Retractor only
CFS-13-878-00	Complete set consisting of:
CFS-13-878-01	1 Retractor
	1 pair of blades 13-888-45 to 13-888-65



Caspar
 Fig. 2

CFS-13-879-01	Retractor only
CFS-13-879-00	Complete set consisting of:
CFS-13-879-01	1 Retractor
	1 pair of blades 13-888-45 to 13-888-65



Caspar
 Fig. 3

CFS-13-880-03	Retractor only
CFS-13-880-00	Complete set consisting of:
CFS-13-880-03	1 Retractor
	1 pair of blades 13-884-40 to 13-884-60
	1 pair of blades 13-885-40 to 13-885-60





Blade Opener

CFS-13-881-11

11.5 cm - 4 1/2"
Forceps for changing
the blades

Blade Inserter

CFS-13-882-20

20 cm - 8"
Ferrozell handle

CFS-13-883-20

20 cm - 8"
Propylux handle

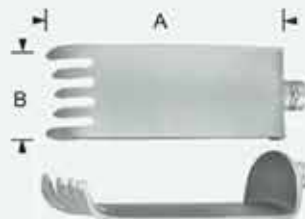

5 Prongs Blade A B

CFS-13-884-40	40 x 23 mm
CFS-13-884-45	45 x 23 mm
CFS-13-884-50	50 x 23 mm
CFS-13-884-55	55 x 23 mm
CFS-13-884-60	60 x 23 mm
CFS-13-884-65	65 x 23 mm
CFS-13-884-75	75 x 23 mm

Medial

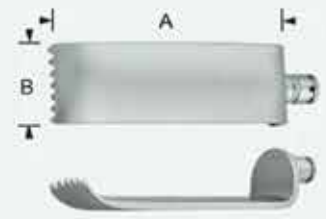

Toothed Blade A B

CFS-13-885-40	40 x 23 mm
CFS-13-885-45	45 x 23 mm
CFS-13-885-50	50 x 23 mm
CFS-13-885-55	55 x 23 mm
CFS-13-885-60	60 x 23 mm
CFS-13-885-65	65 x 23 mm
CFS-13-885-75	75 x 23 mm

Lateral



4 Prongs Blade A B

CFS-13-886-40	40 x 23 mm
CFS-13-886-45	45 x 23 mm
CFS-13-886-50	50 x 23 mm
CFS-13-886-55	55 x 23 mm
CFS-13-886-60	60 x 23 mm
CFS-13-886-65	65 x 23 mm



Toothed Blade A B

CFS-13-887-40	40 x 23 mm
CFS-13-887-45	45 x 23 mm
CFS-13-887-50	50 x 23 mm
CFS-13-887-55	55 x 23 mm
CFS-13-887-60	60 x 23 mm
CFS-13-887-65	65 x 23 mm

9
220
210
8
200
190
7
180
170
160
6
150
140
130
5
120
110
4
100
90
80
3
70
60
2
50
40
1
30
20
10
INCHES
MILLIMETERS



Concave Blade	A	B
CFS-13-888-40	40 x 23 mm	
CFS-13-888-45	45 x 23 mm	
CFS-13-888-50	50 x 23 mm	
CFS-13-888-55	55 x 23 mm	
CFS-13-888-60	60 x 23 mm	
CFS-13-888-65	65 x 23 mm	
CFS-13-888-70	70 x 23 mm	
CFS-13-888-75	75 x 23 mm	

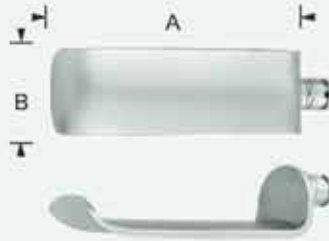

Blunt Blade	A	B
CFS-13-889-40	40 x 23 mm	
CFS-13-889-45	45 x 23 mm	
CFS-13-889-50	50 x 23 mm	
CFS-13-889-55	55 x 23 mm	
CFS-13-889-60	60 x 23 mm	
CFS-13-889-65	65 x 23 mm	

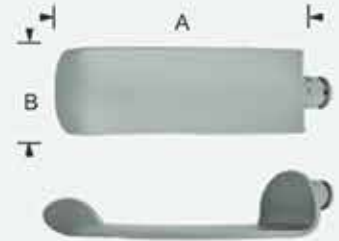

Blunt Blade	A	B
CFS-13-890-30	30 x 20 mm	
CFS-13-890-35	35 x 20 mm	
CFS-13-890-40	40 x 20 mm	
CFS-13-890-45	45 x 20 mm	
CFS-13-890-50	50 x 20 mm	
CFS-13-890-55	55 x 20 mm	
CFS-13-890-60	60 x 20 mm	
CFS-13-890-65	65 x 20 mm	
CFS-13-890-70	70 x 20 mm	
CFS-13-890-75	75 x 20 mm	

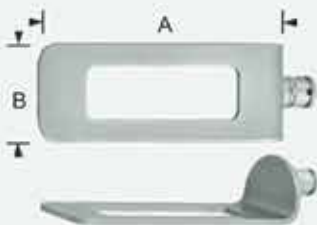

Blunt Blade	A	B
CFS-13-891-50	50 x 25 mm	
CFS-13-891-60	60 x 25 mm	

Blades for harvesting of the fusion graft from the iliac crest, blunt

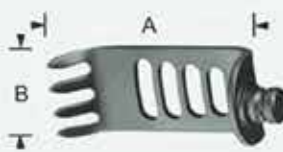

Fenestrated Blade Fig. 1	A	B
CFS-13-892-25	25 x 20 mm	
CFS-13-892-30	30 x 20 mm	
CFS-13-892-35	35 x 20 mm	
CFS-13-892-40	40 x 20 mm	
CFS-13-892-45	45 x 20 mm	
CFS-13-892-50	50 x 20 mm	
CFS-13-892-55	55 x 20 mm	
CFS-13-892-60	60 x 20 mm	
CFS-13-892-65	65 x 20 mm	
CFS-13-892-70	70 x 20 mm	

Medial



Fenestrated Blade Fig. 2	A	B
CFS-13-893-25	25 x 20 mm	
CFS-13-893-30	30 x 20 mm	
CFS-13-893-35	35 x 20 mm	
CFS-13-893-40	40 x 20 mm	
CFS-13-893-45	45 x 20 mm	
CFS-13-893-50	50 x 20 mm	
CFS-13-893-55	55 x 20 mm	
CFS-13-893-60	60 x 20 mm	
CFS-13-893-65	65 x 20 mm	
CFS-13-893-70	70 x 20 mm	

Lateral





Cervical Spin
Fig. 1

CFS-13-894-13	Retractor only	13.5 cm - 5 1/4"
CFS-13-894-00	Complete set consisting of:	
CFS-13-894-13	1 Retractor	
	1 pair of blades 13-884-40 to 13-884-60	
	1 pair of blades 13-885-40 to 13-885-60	

Transverse retractor, double hinged



Cervical Spin
Fig. 2

CFS-13-895-20	Retractor only	20 cm - 8"
CFS-13-895-00	Complete set consisting of:	
CFS-13-895-20	1 Retractor	
	1 pair of blades 13-884-40 to 13-884-60	
	1 pair of blades 13-885-40 to 13-885-60	

Transverse retractor, double hinged

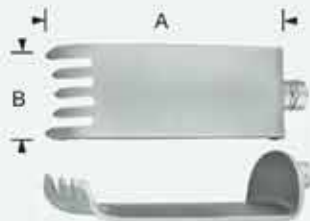

5 Prongs Blade	A	B
CFS-13-884-40	40 x 23 mm	
CFS-13-884-45	45 x 23 mm	
CFS-13-884-50	50 x 23 mm	
CFS-13-884-55	55 x 23 mm	
CFS-13-884-60	60 x 23 mm	
CFS-13-884-65	65 x 23 mm	
CFS-13-884-75	75 x 23 mm	

Medial

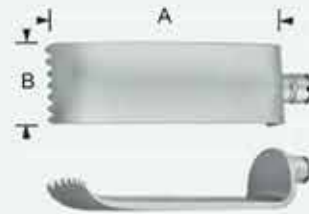

Toothed Blade	A	B
CFS-13-885-40	40 x 23 mm	
CFS-13-885-45	45 x 23 mm	
CFS-13-885-50	50 x 23 mm	
CFS-13-885-55	55 x 23 mm	
CFS-13-885-60	60 x 23 mm	
CFS-13-885-65	65 x 23 mm	
CFS-13-885-75	75 x 23 mm	

Lateral



Cervical Spin
Fig. 3

		A	
CFS-13-896-17	Retractor only	90mm	17 cm - 6 3/4"
CFS-13-896-00	Complete set consisting of:		
CFS-13-896-17	1 Retractor		
	1 pair of blades	13-884-40 to 13-884-60	
	1 pair of blades	13-885-40 to 13-885-60	

Retractor, double hinged, open blade reception



Cervical Spin
Fig. 4

		A	B	C	
CFS-13-897-11	Retractor only	90mm	115mm	130mm	11.5 cm - 4 1/2"
CFS-13-897-00	Complete set consisting of:				
CFS-13-897-11	1 Retractor				
	1 pair of blades	13-884-40 to 13-884-60			
	1 pair of blades	13-885-40 to 13-885-60			

Retractor, double hinged, open blade reception

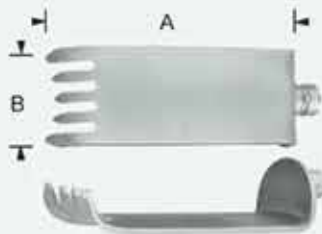

	A	B
CFS-13-884-40	40x23 mm	
CFS-13-884-45	45x23 mm	
CFS-13-884-50	50x23 mm	
CFS-13-884-55	55x23 mm	
CFS-13-884-60	60x23 mm	
CFS-13-884-65	65x23 mm	
CFS-13-884-75	75x23 mm	

Medial

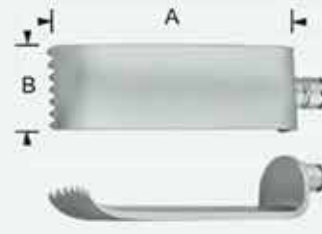

	A	B
CFS-13-885-40	40x23 mm	
CFS-13-885-45	45x23 mm	
CFS-13-885-50	50x23 mm	
CFS-13-885-55	55x23 mm	
CFS-13-885-60	60x23 mm	
CFS-13-885-65	65x23 mm	
CFS-13-885-75	75x23 mm	

Lateral





Cervical Spin
Fig. 5

CFS-13-898-13	Retractor only	13.5 cm - 5 1/4"
CFS-13-898-00	Complete set consisting of:	
CFS-13-898-13	1 Retractor	
	1 pair of blades 13-900-40 to 13-900-60	
	1 pair of blades 13-901-40 to 13-901-60	
	1 pair of blades 13-902-40 to 13-902-60	

Transverse retractor, double hinged



Cervical Spin
Fig. 6

CFS-13-899-20	Retractor only	20 cm - 8"
CFS-13-899-00	Complete set consisting of:	
CFS-13-899-20	1 Retractor	
	1 pair of blades 13-900-40 to 13-900-60	
	1 pair of blades 13-901-40 to 13-901-60	
	1 pair of blades 13-902-40 to 13-902-60	

Transverse retractor, double hinged



	A	B
CFS-13-900-40	40 x 23 mm	
CFS-13-900-45	45 x 23 mm	
CFS-13-900-50	50 x 23 mm	
CFS-13-900-55	55 x 23 mm	
CFS-13-900-60	60 x 23 mm	
CFS-13-900-65	65 x 23 mm	
CFS-13-900-70	70 x 23 mm	
CFS-13-900-75	75 x 23 mm	

Blades, medial



	A	B
CFS-13-901-40	40 x 23 mm	
CFS-13-901-45	45 x 23 mm	
CFS-13-901-50	50 x 23 mm	
CFS-13-901-55	55 x 23 mm	
CFS-13-901-60	60 x 23 mm	
CFS-13-901-65	65 x 23 mm	
CFS-13-901-70	70 x 23 mm	
CFS-13-901-75	75 x 23 mm	

Blades, lateral



	A	B
CFS-13-902-40	40 x 23 mm	
CFS-13-902-45	45 x 23 mm	
CFS-13-902-50	50 x 23 mm	
CFS-13-902-55	55 x 23 mm	
CFS-13-902-60	60 x 23 mm	
CFS-13-902-65	65 x 23 mm	
CFS-13-902-70	70 x 23 mm	
CFS-13-902-75	75 x 23 mm	

Blades, blunt





Mc Culloch
CFS-13-903-01
Rigid



Mc Culloch
CFS-13-904-01 Retractor only
CFS-13-904-00 Complete set consisting of:
CFS-13-904-01 1 Retractor
1 pair of blades 13-905-40 to 13-905-60
1 pair of blades 13-906-40 to 13-906-60
1 pair of blades 13-907-40 to 13-907-60
CFS-21-454-03 1 Wire basket 540 x 255 x 70mm
CFS-21-627-04 2 Silicone mats 380 x 230 mm
Hinged

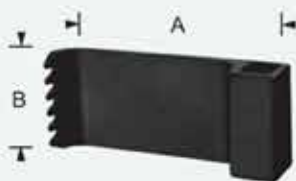

	A	B	
CFS-13-905-30	30 x 23 mm		1 piece
CFS-13-905-40	40 x 23 mm		1 piece
CFS-13-905-50	50 x 23 mm		1 piece
CFS-13-905-60	60 x 23 mm		1 piece
CFS-13-905-70	70 x 23 mm		1 piece
CFS-13-905-80	80 x 23 mm		1 piece
CFS-13-905-00	Set		1 pair each

Muscle blades, wide



	A	B	
CFS-13-906-30	30 x 20 mm		1 piece
CFS-13-906-40	40 x 20 mm		1 piece
CFS-13-906-50	50 x 20 mm		1 piece
CFS-13-906-60	60 x 20 mm		1 piece
CFS-13-906-70	70 x 20 mm		1 piece
CFS-13-906-80	80 x 20 mm		1 piece
CFS-13-906-00	Set		1 pair each

Muscle blades, narrow

 add "C" with catalogue part number if required in black ceramic coating



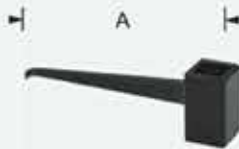

	A	
CFS-13-907-20	20 mm	1 piece
CFS-13-907-30	30 mm	1 piece
CFS-13-907-40	40 mm	1 piece
CFS-13-907-50	50 mm	1 piece
CFS-13-907-60	60 mm	1 piece
CFS-13-907-70	70 mm	1 piece
CFS-13-907-00	Set	1 pair each

Hook blades



	A	
CFS-13-908-20	20 mm	1 piece
CFS-13-908-30	30 mm	1 piece
CFS-13-908-40	40 mm	1 piece
CFS-13-908-50	50 mm	1 piece
CFS-13-908-60	60 mm	1 piece
CFS-13-908-70	70 mm	1 piece
CFS-13-908-00	Set	1 pair each

Hook blades



	A	B	
CFS-13-909-30	30 x 17 mm		1 piece
CFS-13-909-40	40 x 17 mm		1 piece
CFS-13-909-50	50 x 17 mm		1 piece
CFS-13-909-60	60 x 17 mm		1 piece
CFS-13-909-70	70 x 17 mm		1 piece
CFS-13-909-80	80 x 17 mm		1 piece
CFS-13-909-00	Set		1 pair each

Thin muscle blades



	A	B	
CFS-13-910-50	50 x 20 mm		1 piece
CFS-13-910-60	60 x 20 mm		1 piece
CFS-13-910-70	70 x 20 mm		1 piece
CFS-13-910-00	Set		1 pair each

Cervical blades

 add "C" with catalogue part number if required in black ceramic coating

9
220
210
8
200
190
7
180
170
160
6
150
140
130
5
120
110
4
100
90
3
80
70
60
2
50
40
30
1
20
10
INCHES
MILLIMETERS



Caspar	Blade length
CFS-13-911-40	40 mm
CFS-13-911-45	45 mm
CFS-13-911-50	50 mm
CFS-13-911-55	55 mm
CFS-13-911-60	60 mm
CFS-13-911-65	65 mm
CFS-13-911-70	70 mm
CFS-13-911-75	75 mm
CFS-13-911-85	85 mm

Specula



Caspar
CFS-13-912-00
Counter retractor frame



	A B
CFS-13-913-35	35 x 15 mm
CFS-13-913-40	40 x 15 mm
CFS-13-913-45	45 x 15 mm
CFS-13-913-50	50 x 15 mm
CFS-13-913-55	55 x 15 mm
CFS-13-913-60	60 x 15 mm
CFS-13-913-65	65 x 15 mm
CFS-13-913-70	70 x 15 mm
CFS-13-913-75	75 x 15 mm
CFS-13-913-85	85 x 15 mm

Blades, lateral



	A B
CFS-13-914-40	40 x 15 mm
CFS-13-914-45	45 x 15 mm
CFS-13-914-50	50 x 15 mm
CFS-13-914-55	55 x 15 mm
CFS-13-914-60	60 x 15 mm
CFS-13-914-65	65 x 15 mm
CFS-13-914-70	70 x 15 mm

Blades, medial

add "C" with catalogue part number if required in black ceramic coating





i Vertebral body distractor, for use in surgical procedures from the left approach for C5 through T1/2 and from the right approach for the upper cervical spine.



Cervical Body Distractor, Left
CFS-13-915-00

Vertebral body distractor left only with standard prolonged toothed bar (length 113 mm)



Drill Guide, Left
CFS-13-916-00

Drill guide, for parallel positioning of the distraction screws, to be used with distractor 13-915-00

i Vertebral body distractor, for use in surgical procedures from the right approach for C5 through T1/2 and from the left approach for the upper cervical spine.



Cervical Body Distractor, Right
CFS-13-917-00

Vertebral body distractor right only with standard prolonged toothed bar (length 113 mm)



Drill Guide, Right
CFS-13-918-00

Drill guide, for parallel positioning of the distraction screws, to be used with distractor 13-917-00



Cervical Body Distractor, Left
CFS-13-919-00

Spreading right, 110 mm wide,
total opening 70 mm,
depths of shank 60 mm



Cervical Body Distractor, Right
CFS-13-920-00

Spreading left, 110 mm wide,
total opening 70 mm,
depths of shank 60 mm



Distraction Screw

CFS-13-921-12	12 mm
CFS-13-921-14	14 mm
CFS-13-921-16	16 mm
CFS-13-921-18	18 mm

7 cm - 2 3/4"

Distraction screws
to be used with distractors
13-915-00 and 13-917-00
at least 2 each are required
Packing unit of 2 pieces



Distraction Screw Modified A

CFS-13-922-12	90 mm	12 mm
CFS-13-922-14	92 mm	14 mm
CFS-13-922-16	94 mm	16 mm



Twist Drill

CFS-13-923-14

14.5 cm - 5 3/4"
Ø 1.7 mm,
for pre-drilling holes for
distraction screws,
Drilling depth: 8 mm,
sheath Ø 2.35 mm





Screw Driver

CFS-13-924-01 20 cm - 8"

For distraction screws
Ferozell handle

CFS-13-924-02 20 cm - 8"

For distraction screws
Propylux handle



Bone Graft Holder

CFS-13-925-01 22 cm - 8 3/4"

Insertion instrument
Ferozell handle

CFS-13-925-02 22 cm - 8 3/4"

Insertion instrument
Propylux handle



Fig. 1













Fig. 2

Dissector

CFS-13-926-01 Fig. 1

CFS-13-926-02 Fig. 2

20.5 cm - 8"
Vertebral body dissectors
Ferozell handle

	Item No.	Description
	<p>Cervical Retractor Set</p> <p>CFS-13-927-00</p>	<p>Set consisting of:</p>
	<p>CFS-13-878-01</p>	<p>1 Caspar Retractor Fig. 1</p>
	<p>CFS-13-879-02</p>	<p>1 Caspar Retractor Fig. 3</p>
	<p>CFS-13-880-03</p>	<p>2 Micro forceps straight 18 cm - 7"</p>
	<p>CFS-13-179-18</p>	<p>1 Micro forceps straight 18 cm - 7"</p>
	<p>CFS-13-892-25 CFS-13-892-70</p>	<p>1 pair of blades</p>
	<p>CFS-13-893-40 CFS-13-893-70</p>	<p>1 pair of blades</p>
	<p>CFS-13-890-30 CFS-13-890-75</p>	<p>1 pair of blades</p>
	<p>CFS-13-881-00</p>	<p>1 Forceps for changing the blades with ball snap closure</p>
	<p>CFS-21-545-03</p>	<p>1 Wire basket 540 x 255 x 70 mm</p>
	<p>CFS-21-627-04</p>	<p>2 Silicone mats 380 x 230 mm</p>













Item No.	Description
Micro Disectomy Set Fig. 1 CFS-13-928-00	Set consisting of:
① CFS-13-911-40 CFS-13-911-85	1 pair of blades
② CFS-13-912-00	1 Caspar Counter Retractor Frame
③ CFS-13-913-35 CFS-13-913-85	2 Micro forceps straight 18 cm - 7"
④ CFS-13-881-00	1 Forceps for changing the blades with ball snap closure
⑤ CFS-13-227-06 CFS-13-227-10	Caspar nerve root retractors
⑥ CFS-21-515-03	1 Wire basket 540 x 255 x 70 mm
⑦ CFS-21-627-04	2 Silicone mats 380 x 230 mm

Item No.	Description
Micro Disectomy Set Fig. 2 CFS-13-929-00	Set consisting of:
① CFS-13-911-40 CFS-13-911-85	1 pair of blades
② CFS-13-912-00	1 Caspar Counter Retractor Frame
③ CFS-13-913-35 CFS-13-913-85	2 Micro forceps straight 18 cm - 7"
④ CFS-13-881-00	1 Forceps for changing the blades with ball snap closure
⑥ CFS-21-515-03	1 Wire basket 540 x 255 x 70 mm
⑦ CFS-21-627-04	2 Silicone mats 380 x 230 mm



	Item No.	Description
	Micro Disectomy Set Fig. 3 CFS-13-930-00	Set consisting of:
	CFS-13-917-00	1 Caspar Retractor Fig. 1
	CFS-13-918-00	1 Drill guide, right
	CFS-13-924-01	1 Screw driver
	CFS-13-923-14	1 Twist drill
	CFS-13-921-14	10 pcs Distraction screws

	Item No.	Description
	Micro Disectomy Set Fig. 4 CFS-13-931-00	Set consisting of:
	CFS-13-912-00	1 Caspar counter retractor frame
	CFS-13-911-40 CFS-13-911-85	1 pair of blades
	CFS-13-913-40 CFS-13-913-85	1 pair of blades
	CFS-13-881-00	1 Forceps for changing the blades with ball snap closure



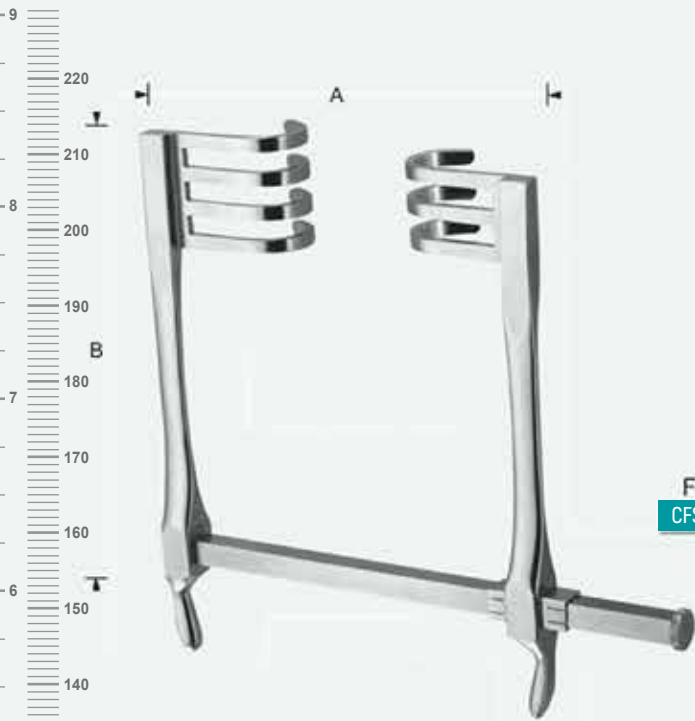

Frazier
CFS-13-932-50 A B
16.5 cm - 6 1/2" 13 cm - 5"

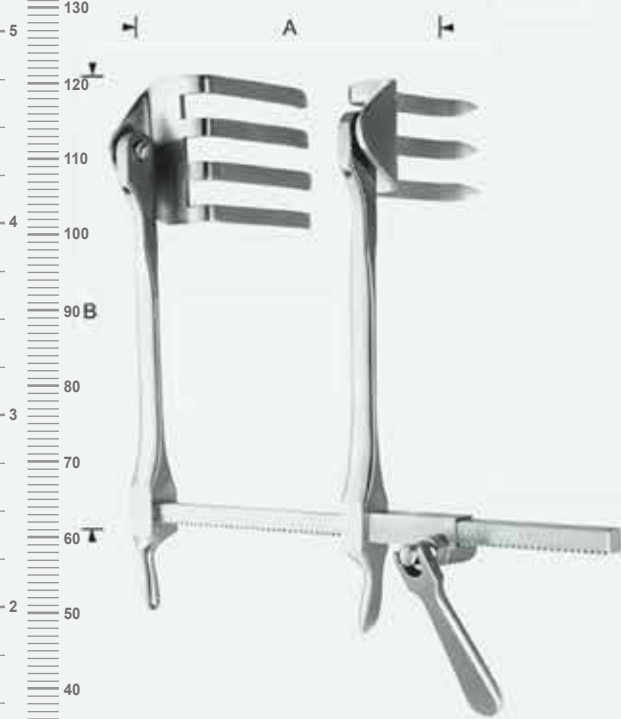

Scoville - Richter		A	B
CFS-13-933-01		14 cm - 5 1/2"	17 cm - 6 3/4"
CFS-13-933-00	Complete set consisting of:		
CFS-13-933-01	1 Retractor	17 cm - 6 3/4"	
		13-934-01 to 13-934-02	
		1 pair of each	

Scoville - Richter			
CFS-13-934-01	Fig. 1	60 x 37 mm	
CFS-13-934-02	Fig. 2	60 x 50 mm	
		1 pair of blades	

Scoville - Richter			
CFS-13-935-03	Fig. 3	48 x 50 mm	
CFS-13-935-04	Fig. 4	28 x 40 mm	
CFS-13-935-05	Fig. 5	38 x 62 mm	
		1 pair of blades	

INCHES
MILLIMETERS

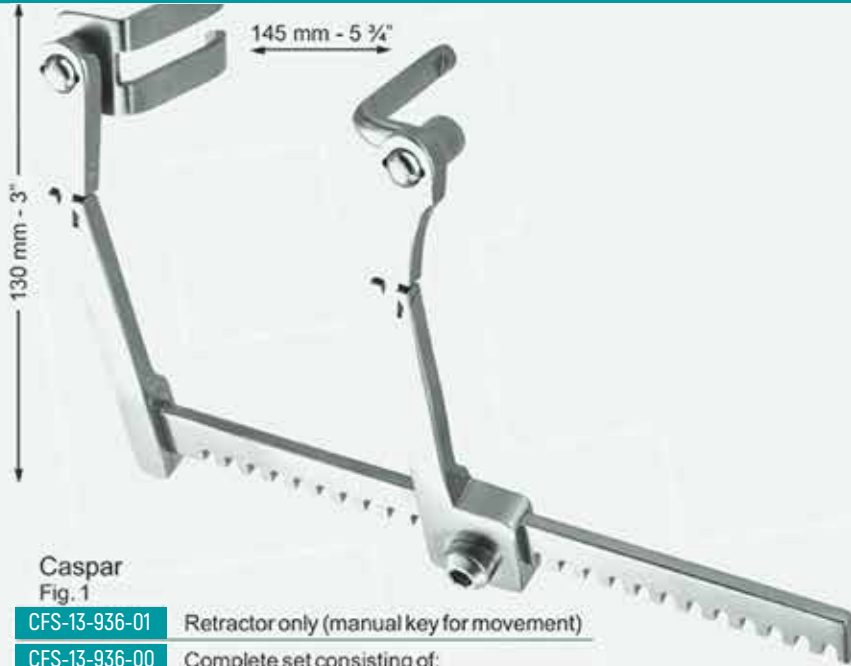

Caspar
Fig. 1

CFS-13-936-01	Retractor only (manual key for movement)
CFS-13-936-00	Complete set consisting of:
CFS-13-936-01	1 Retractor
CFS-13-938-58	1 Hook 58 mm
CFS-13-937-00	Key for retractor movement
	1 pair of each, 13-940-37 and 13-941-41



Key
CFS-13-937-00



Hook
CFS-13-938-38 38 mm
CFS-13-938-58 58 mm

Caspar
Fig. 2

CFS-13-936-02	Retractor only (attached key for movement)
CFS-13-936-00	Complete set consisting of:
CFS-13-936-01	1 Retractor
CFS-13-938-38	1 Hook 38 mm
	1 pair of each, 13-941-37 to 13-941-57

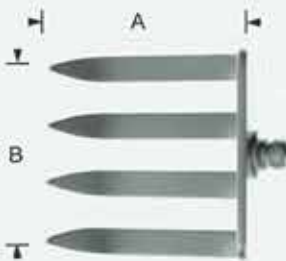

Blade
Fig. 1

	A	B	
CFS-13-939-32	32 x 52 mm		1 piece
CFS-13-939-37	37 x 52 mm		1 piece
CFS-13-939-42	42 x 52 mm		1 piece
CFS-13-939-47	32 x 52 mm		1 piece
CFS-13-939-52	52 x 52 mm		1 piece
CFS-13-939-57	57 x 52 mm		1 piece
CFS-13-939-65	65 x 52 mm		1 piece
CFS-13-939-67	67 x 52 mm		1 piece

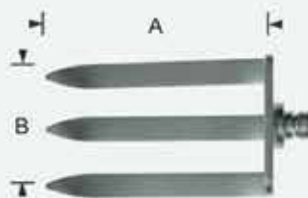

Blade
Fig. 2

	A	B	
CFS-13-940-32	32 x 52 mm		1 piece
CFS-13-940-37	37 x 52 mm		1 piece
CFS-13-940-42	42 x 52 mm		1 piece
CFS-13-940-47	32 x 52 mm		1 piece
CFS-13-940-52	52 x 52 mm		1 piece
CFS-13-940-57	57 x 52 mm		1 piece
CFS-13-940-65	65 x 52 mm		1 piece
CFS-13-940-67	67 x 52 mm		1 piece

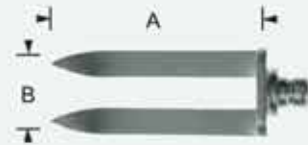

Blade
Fig. 3

	A	B	
CFS-13-941-32	32 x 52 mm		1 piece
CFS-13-941-37	37 x 52 mm		1 piece
CFS-13-941-42	42 x 52 mm		1 piece
CFS-13-941-47	32 x 52 mm		1 piece
CFS-13-941-52	52 x 52 mm		1 piece
CFS-13-941-57	57 x 52 mm		1 piece
CFS-13-941-65	65 x 52 mm		1 piece
CFS-13-941-67	67 x 52 mm		1 piece

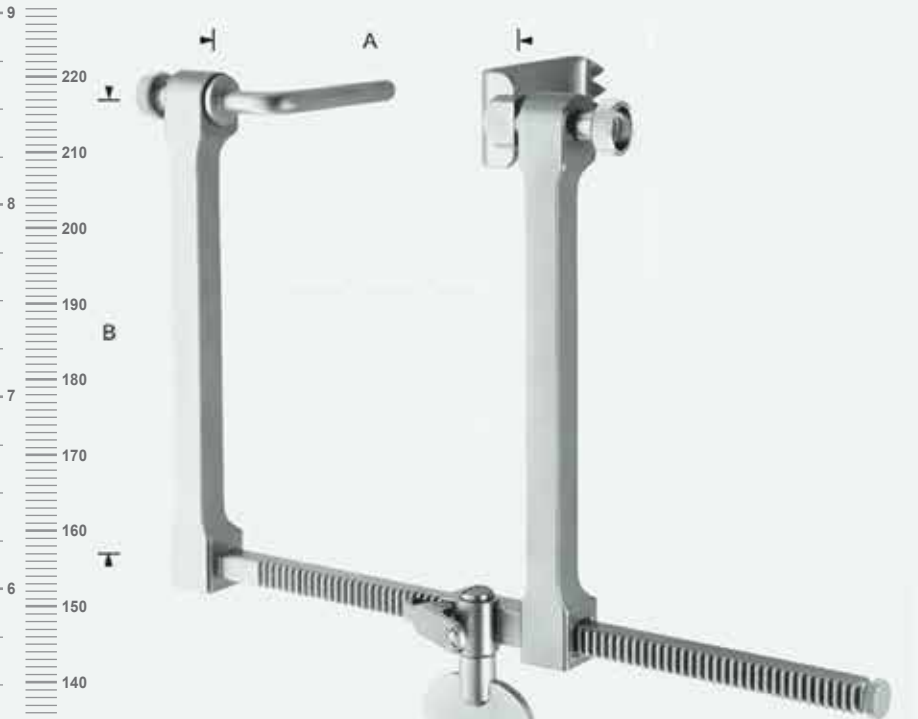

Scoville	A	B	
CFS-13-942-01	22 cm - 8 3/4"	14 cm - 5 1/2"	Retractor only
CFS-13-942-00	Complete set consisting of:		
CFS-13-942-01	1 Retractor		
	1 pair of each, 13-945-47 to 13-945-60		

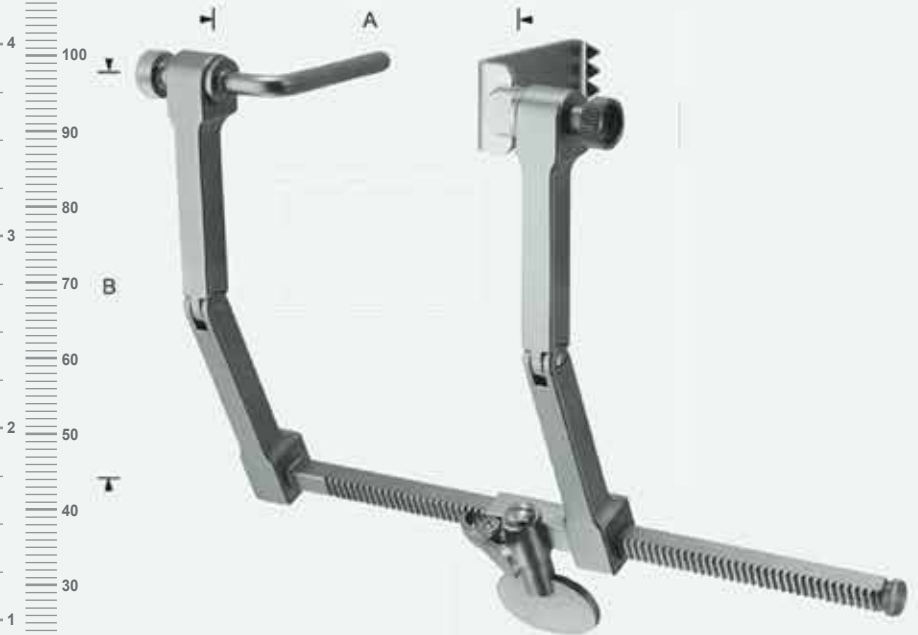

Fig. 1



Fig. 2

Scoville		
CFS-13-945-57	Fig. 1	57 mm
CFS-13-945-60	Fig. 2	60 x 25 mm
	1 pair of blades only	



Scoville - Haverfield A	B	
CFS-13-943-01	22 cm - 8 3/4"	14 cm - 5 1/2"
CFS-13-943-00	Complete set consisting of:	
CFS-13-943-01	1 Retractor	
	1 pair of each, 13-945-57 to 13-945-60	

INCHES
 MILLIMETERS



Scoville	A	B	
CFS-13-944-01	22 cm - 8 3/4"	14 cm - 5 1/2"	Retractor only
CFS-13-944-00	Complete set consisting of:		
CFS-13-944-01	1 Retractor		
	1 pair of each, 13-947-48 to 13-947-78		



Scoville	
CFS-13-947-48	48 mm
CFS-13-947-58	58 mm
CFS-13-947-78	78 mm



Meyerding	
CFS-13-956-48	48 x 25 mm
CFS-13-956-81	81 x 25 mm
CFS-13-956-90	90 x 50 mm





Scoville

CFS-13-945-57	57 mm
CFS-13-945-83	83 mm

Blunt, wide



Scoville

CFS-13-946-57	57 mm
CFS-13-946-71	71 mm

Sharp



Scoville

CFS-13-947-48	48 mm
CFS-13-947-58	58 mm
CFS-13-947-78	78 mm

With crossbar

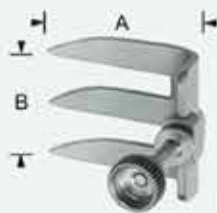

**Taylor/
Scoville**

	A	B
CFS-13-948-45	45 x 39 mm	
CFS-13-948-50	50 x 35 mm	

3 prongs

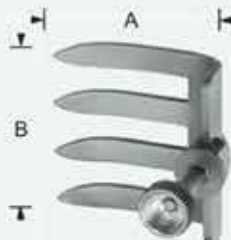

**Taylor/
Scoville**

	A	B
CFS-13-949-70	70 x 46 mm	
CFS-13-949-50	50 x 50 mm	
CFS-13-949-62	62 x 57 mm	
CFS-13-949-80	80 x 57 mm	

4 prongs

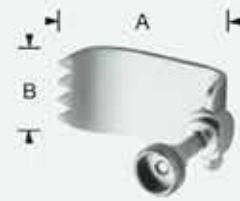

Hibbs

	A	B
CFS-13-950-48	48 x 19 mm	
CFS-13-950-58	58 x 51 mm	
CFS-13-950-51	51 x 26 mm	
CFS-13-950-60	60 x 38 mm	
CFS-13-950-65	65 x 26 mm	
CFS-13-950-74	74 x 38 mm	
CFS-13-950-74	74 x 64 mm	
CFS-13-950-78	78 x 50 mm	
CFS-13-950-80	80 x 26 mm	
CFS-13-950-89	89 x 26 mm	
CFS-13-950-90	92 x 39 mm	
CFS-13-950-10	104 x 51 mm	
CFS-13-950-10	105 x 26 mm	

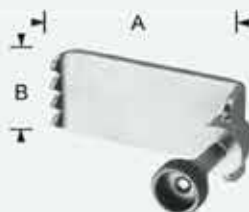

Scoville

	A	B
CFS-13-953-60	60 x 25 mm	
CFS-13-953-78	78 x 51 mm	
CFS-13-953-78	78 x 29 mm	
CFS-13-953-91	91 x 26 mm	

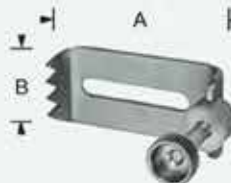

Epstein

	A	B
CFS-13-955-70	57 x 26 mm	

Fenestrated



Meyerding

	A	B
CFS-13-956-48	48 x 25 mm	
CFS-13-956-62	62 x 25 mm	
CFS-13-956-70	70 x 25 mm	
CFS-13-956-78	78 x 25 mm	
CFS-13-956-81	81 x 25 mm	
CFS-13-956-90	90 x 50 mm	



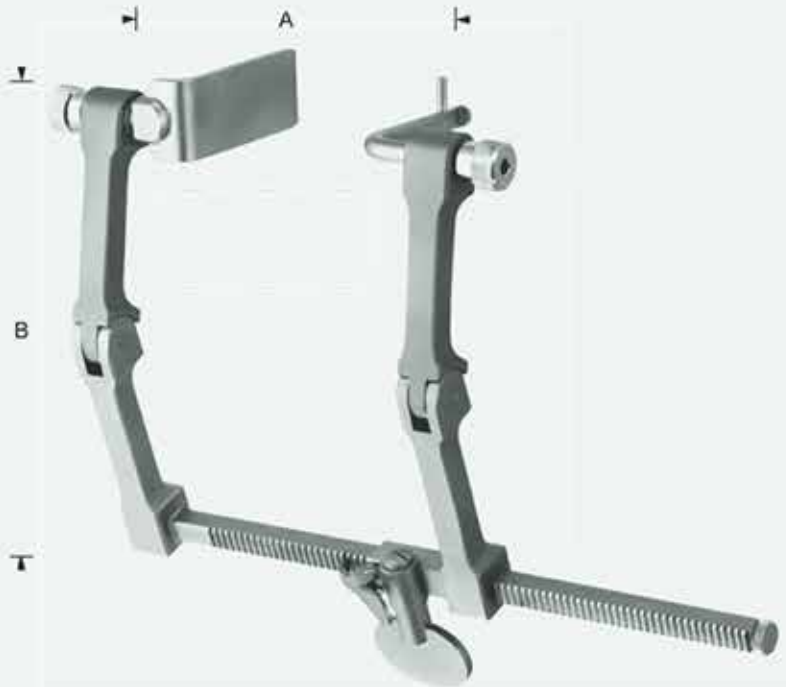

Scoville	A	B	
CFS-13-957-01	22 cm - 8 3/4"	14 cm - 5 1/2"	Retractor only
CFS-13-957-00	Complete set consisting of:		
CFS-13-957-01	1 Retractor		
CFS-13-959-60	1 blade		
CFS-13-959-58	1 blade		



Meyerding	A	B
CFS-13-958-48	48 x 25 mm	
CFS-13-958-62	62 x 25 mm	
CFS-13-958-70	70 x 25 mm	
CFS-13-958-78	78 x 25 mm	
CFS-13-958-81	81 x 25 mm	
CFS-13-958-90	90 x 50 mm	

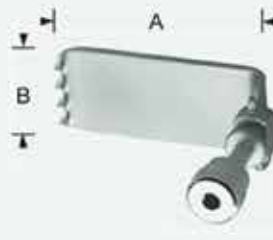

Scoville	A	B
CFS-13-959-60	60 x 25 mm	
CFS-13-959-78	78 x 29 mm	
CFS-13-959-78	78 x 51 mm	
CFS-13-959-91	91 x 26 mm	

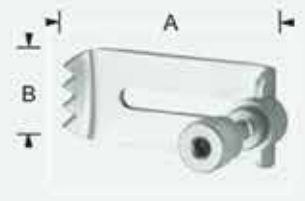

Epstein	A	B
CFS-13-960-48	48 x 26 mm	

Fenestrated



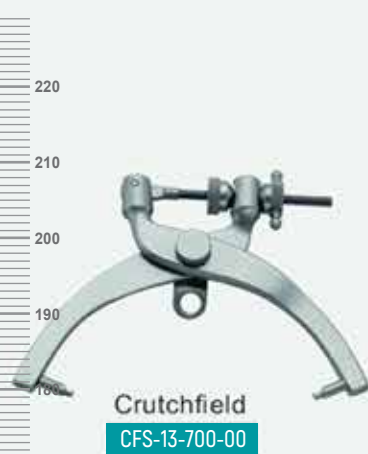

Crutchfield
CFS-13-700-00



CFS-13-701-00
 3.5mmØ



CFS-13-702-00
 5.0 mmØ



Crutchfield
CFS-13-703-00



Cervical Tong
CFS-13-704-00

large type, cervical traction tongs – pins adjustable no drilling to be done
 grosses Modell, für Extension der Halswirbel – kein Vorbohren erforderlich – Dorne verstellbar
 modelo grande, distractor cervical – espigas ajustables sin necesidad de trepanar
 modèle large, distracteur cervicale – poinçons ajustables pas de perçage nécessaire
 modello grande, distrattore cervicale, pin aadjustabili, non necessita di perforare, regolabili

CFS-13-705-00

Spare pin
 Ersatzdorn
 Pivote de cambio
 Goupille de rechange
 Punta di ricambio



Wrench
CFS-13-706-00

Wrench, double-ended
 Gabelschlüssel, doppelendig
 Llave de tuercas
 Clé de fixation,
 Chiave



Extension piece
 Verlängerungsstück
 Pieza de prolongación
 Pièce d'extension
 Pezzo di prolungazione



Hudson

CFS-13-707-01	Complete set consisting:
CFS-13-707-27	Drill handle
	4 twist drills (Fig. 1 to Fig. 4)

Hudson

CFS-13-707-02	Complete set consisting:
CFS-13-707-27	Drill handle
	6 twist drills (Fig. 1 to Fig. 6)
	1 extension piece





Adson

CFS-13-715-15 15 cm - 6"



De Vibiss

CFS-13-716-21 21 cm - 8 1/4"



Olivecrona

- CFS-13-718-30 30 cm - 12"
- CFS-13-718-40 40 cm - 16"
- CFS-13-718-50 50 cm - 20"
- CFS-13-718-60 60 cm - 23 1/2"
- CFS-13-718-70 70 cm - 27 1/2"

6 wires twisted
 6-teilig
 6 alambres torcidos
 6 fils tordus
 6 fili attorcigliati

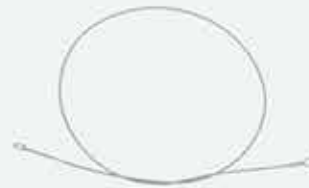

Gigli

- CFS-13-719-30 30 cm - 12"
- CFS-13-719-40 40 cm - 16"
- CFS-13-719-50 50 cm - 20"

6 wires twisted
 6-teilig
 6 alambres torcidos
 6 fils tordus
 6 fili attorcigliati



Gigli

CFS-13-720-00

De Martel

CFS-13-717-33
 33 cm - 13"



Leyla

CFS-13-721-00

Brain retractor self-retaining, with 1 flexible arm, complete, consisting of: fixation base for 1 flexible arm, flexible arm only, support for flat brain spatulas

Selbsthaltender Hirnretraktor, flexibel mit 1 Spannarm, komplett, bestehend aus: Fixierungsvorrichtung für 1 Spannarm, Spannarm und Spatelhalter für flache Spatel

Separador cerebral autostático, 1 brazo flexible con soporte, completo con brazo y soporte para spatulas llanas

Retractor cérébrale autostatique, flexible avec 1 tendeur, complet avec support pour 1 tendeur, tendeur et porte-spatule pour spatules plates

Retrattore cerebrale autostatico, flessibile Completo, contiene: supporto di fissaggio per un braccio, 1 braccio flessibile con supporto di fissaggio per spatole piatte

Leyla

CFS-13-722-00

Brain retractor self-retaining, with 2 flexible arms, complete, consisting of: fixation base for 2 flexible arms, 2 flexible arms, 2 supports for flat brain spatulas

Selbsthaltender Hirnretraktor, flexibel mit 2 Spannarmen, komplett, bestehend aus: Fixierungsvorrichtung für 2 Spannarme, 2 Spannarme und 2 Spatelhalter für flache Spatel

Separador cerebral autostático, 2 brazos flexibles con soporte, completo con brazos y soporte para 2 spatulas llanas

Retractor cérébrale autostatique, flexible avec 2 tendeurs, complet avec supports pour 2 tendeurs, 2 tendeurs et 2 portes-spatule pour spatules plates

Retrattore cerebrale autostatico, flessibile con 2 bracci completi, contiene: supporto di fissaggio per bracci per 2 spatole piatte



Leyla

CFS-13-723-00

Fixation base only, holding 2 flexible arms
 Fixierungsvorrichtung allein, für 2 Spannarme
 Soporte solo para 2 brazos de separador
 Support seul pour 2 tendeurs
 Supporto di fissaggio per 2 bracci, solo

CFS-13-724-00

Fixation base only, holding 1 flexible arm
 Fixierungsvorrichtung allein, für 1 Spannarm
 Soporte solo para 1 brazo de separador
 Support seul pour 1 tendeur
 Supporto di fissaggio per 1 braccio, solo

CFS-13-725-00

Support only, for flat brain spatulas
 Spatelhalter allein, für Flachspatel
 Soporte solo, para spatulas planos
 Porte-spatule seul, pour spatules plates
 Supporto solo, per fissaggio di spatole piatte

CFS-13-726-00

Support only, for brain spatulas with round shaft
 of 4mm and 5mm Ø to fix on the flexible arm
 Spatelhalter allein, für Spatel mit Rundschaft
 von 4mm und 5mm Ø, zum Befestigen am Spannarm
 Soporte solo para la fijación de spatulas
 de 4mm y 5mm Ø al brazo
 Porte-spatule seul pour la fixation des spatules
 de 4mm et 5mm Ø diam
 Supporto solo per spatole con asta tonda
 di Ø 4mm e 5mm

CFS-13-727-00

Flexible arm only – for attaching coupling heads and
 for fixation bases
 Spannarm allein – zum Aufstecken auf Kupplungsköpfe
 und Fixierungsvorrichtungen
 Brazo flejible solo para montar sobre soportes
 Tendeur flexible seul – pour le montage sur supports
 et accouplements
 Braccio flessibile solo – per il montaggio sul supporto
 di fissaggio



Leyla

CFS-13-728-00

Brain Retractor, flexible, for one flat spatula complete, consisting of:

- Fixation Base for one flexible arm
- Flexible Arm
- Support for flat brain spatulas

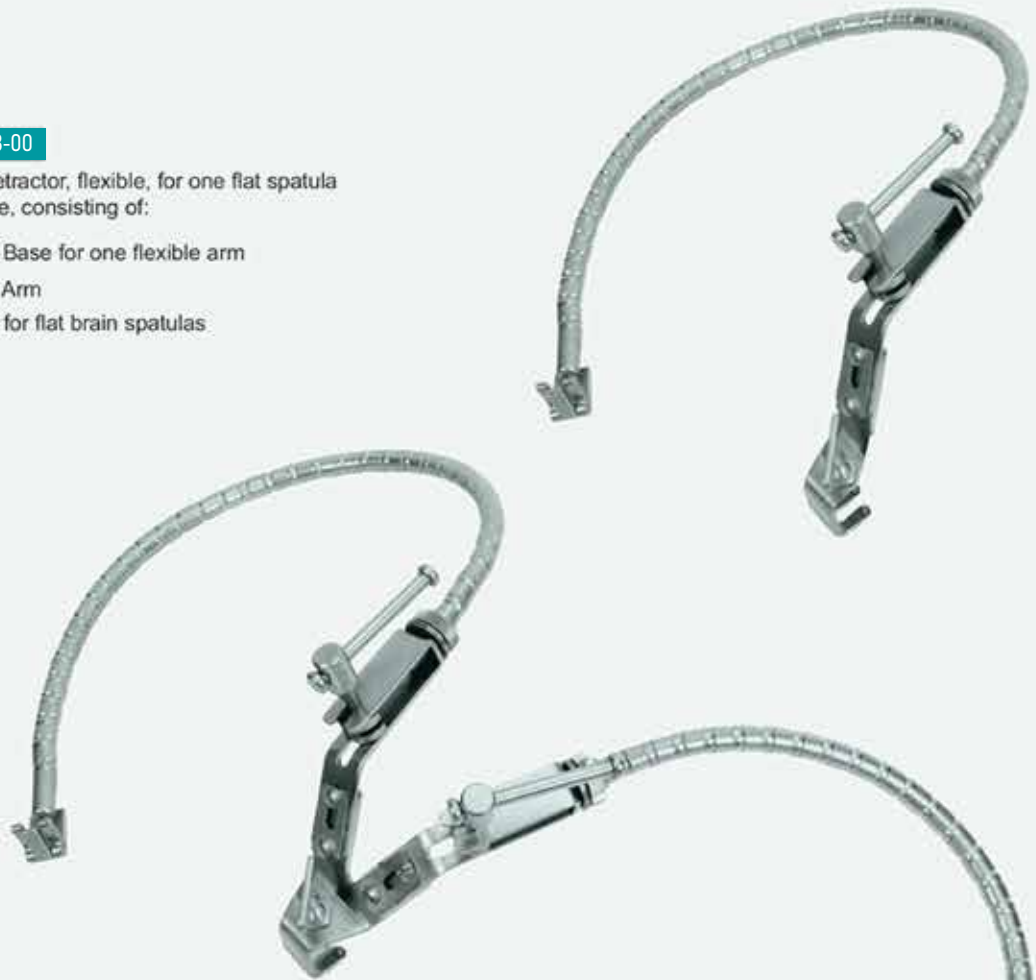

Leyla

CFS-13-729-00

Brain Retractor, flexible, for two flat spatulas complete, consisting of:

- Fixation Base for two flexible arms
- 2 Flexible Arms
- 2 Support for flat brain spatulas



CFS-13-730-00

Flexible Arm

CFS-13-731-00

Spare Part

CFS-13-732-00

Wire Cable, only





Leyla
Fig. 1

CFS-13-433-00

Fixation Base for skull mounting,
holding one flexible arm



Leyla
Fig. 2

CFS-13-434-00

Fixation Base for skull mounting,
holding two flexible arms



Leyla
Fig. 3

CFS-13-435-00

Support, only, for flat brain spatulas,
for fixation at the flexible arm



Leyla
Fig. 4

CFS-13-436-00

Support, only, for brain spatulas with round shaft
up to 5.5 mm diam., for fixation at the flexible arm



Leyla
Fig. 5

CFS-13-437-00

Fixation Base for mounting on bars up to Ø 16 mm
for one flexible arm





Leyla

Fig. 1

CFS-13-438-00

Self-Retaining Retractor for fixation to the operation table, complete, consisting of:

Ball and Socket Joint

Holding Arm

Coupling Head

2 Flexible Arms

2 Supports for flat spatulas

Brain Spatula

Brain Spatula



Leyla

Fig. 2

CFS-13-439-00

Self-Retaining Retractor for fixation to the operation table, without support, consisting of:

Ball and Socket Joint

Holding Arm

Coupling Head, laterally open, to hold one flexible arm

Flexible Arm





CFS-13-440-00

Holding Arm, detachable, for fixation in ball and socket joint for holding one of the coupling heads



CFS-13-441-00

Ball and Socket Joint for fixation at the operating for holding arm table



CFS-13-442-00

Flexible Arm

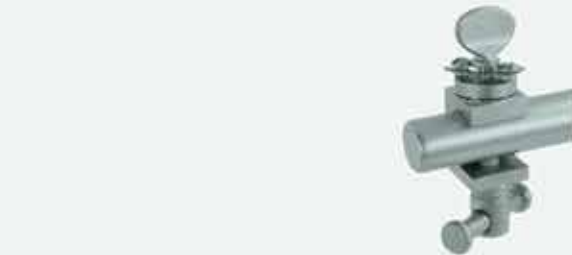

CFS-13-443-00

Spare Part



CFS-13-444-00

Wire Cable, only



CFS-13-445-00

Coupling Head, laterally open, to hold one flexible arm

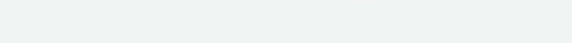

CFS-13-446-00

Coupling Head, rotatable, to hold one flexible arm

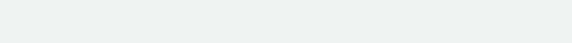

CFS-13-447-00

Coupling Head, to hold max. five flexible arms



Ammy

CFS-13-448-12	20 cm - 8"	12 mm
CFS-13-448-17	20 cm - 8"	17 mm
CFS-13-448-20	20 cm - 8"	20 mm
CFS-13-448-25	20 cm - 8"	25 mm
CFS-13-448-25	25 cm - 10"	25 mm

malleable



Heifetz

CFS-13-452-08	8 mm
CFS-13-452-11	11 mm
CFS-13-452-14	14 mm
CFS-13-452-17	17 mm

15.5 cm - 6"
malleable



Mod. Aachen

CFS-13-457-07	7+8 mm
CFS-13-457-10	10+11mm
CFS-13-457-13	13+14 mm
CFS-13-457-16	16+17 mm
CFS-13-457-19	19+20 mm
CFS-13-457-22	22+25 mm

20 cm - 8"
malleable



Davis

CFS-13-458-06	6 mm
CFS-13-458-10	10 mm
CFS-13-458-14	14 mm
CFS-13-458-16	16 mm
CFS-13-458-19	19 mm
CFS-13-458-25	25 mm
CFS-13-458-32	32 mm
CFS-13-458-38	38 mm

18 cm - 7"
malleable



Scoville

CFS-13-459-10	10+13 mm
CFS-13-459-16	16+17 mm

20 cm - 8"
malleable



Cushing		Olivecrona		Heifetz		Casper		
CFS-13-728-07	7 mm x 9 mm	CFS-13-729-07	CFS-13-730-07	7 mm x 9 mm	CFS-13-730-08	x = 8 mm	CFS-13-227-04	x=4 mm
CFS-13-728-11	11 mm x 13 mm	CFS-13-729-11	CFS-13-730-11	11 mm x 13 mm	CFS-13-730-11	x = 11 mm	CFS-13-227-06	x=6 mm
CFS-13-728-15	15 mm x 18 mm	CFS-13-729-15	CFS-13-730-15	15 mm x 18 mm	CFS-13-730-14	x = 14 mm	CFS-13-227-08	x=8 mm
CFS-13-728-18	18 mm x 22 mm	CFS-13-729-18	CFS-13-730-18	18 mm x 22 mm	CFS-13-730-17	x = 17 mm	CFS-13-227-10	x=10 mm
18 cm - 7"		18 cm - 7"	18 cm - 7"		20 cm - 8"		247 cm - 9½"	
		convex	concave		malleable			
		konvex	konkav		biegsam			
		convexa	côncava		maleable			
		convexe	concave		malléable			
		convessa	concava		flessibile			



McKenzie

CFS-13-732-15 CFS-13-733-15 15 cm - 6"

CFS-13-732-19 CFS-13-733-19 19 cm - 7 1/2"

Clip applying forceps
Zangen zum Anlegen der Klammern
Pinzas para poner grapas
Pinces pour poser des agrafes
Pinze per mettere le agrafes



McKenzie

CFS-13-734-14 14.8 cm x 4 cm x 6 mm - 5 3/4" x 1 1/2" x 1/2"

Brain clip-rack for 20 clips
Klammerblock für 20 Klammern
Porta-grapas para 20 grapas
Porte-agrales pour 20 agrafes
Supporto port'agrafes per 20 agrafes



CFS-13-735-00

100 Brain clips in plastic box
100 Klammern im Plastikbehälter
100 grapas en tubo de plástico
100 agrafes dans un tube de plastique
100 agrafes nella scatola di plastica





Olivecrona-Toennis
(Scoville)

CFS-13-736-14

x = 14 cm - 5 1/2"



Raney

CFS-13-737-15

15 cm - 6"



Clip
Fig. 1

CFS-13-738-15

Scalp clip "Raney"
Kopfhautklammer "Raney"
Grapa para cuero cabelludo "Raney"
Agrafes pour le cuir chevelu «Raney»
Agrafes per il cuoio capelluto „Raney“



Clip
Fig. 2

CFS-13-739-15

Scalp clip "Köln"
Kopfhautklammer „Köln“
Grapa para cuero cabelludo "Köln"
Agrafes pour le cuir chevelu «Köln»
Agrafes per il cuoio capelluto „Köln“

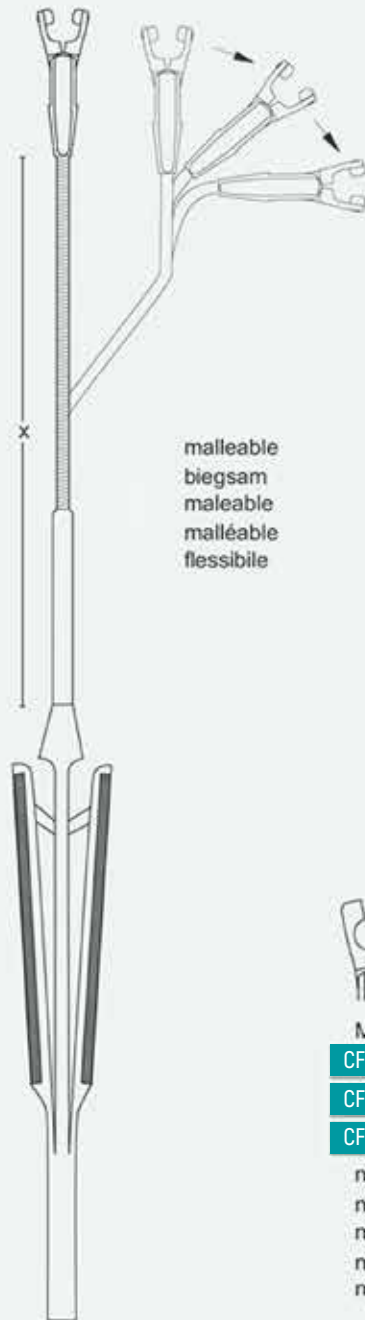

malleable
 biegsam
 maleable
 malléable
 flessibile

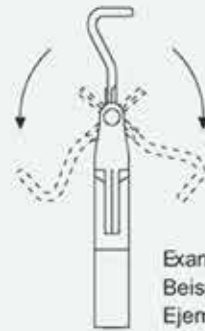

Example for rotation
 Beispiel für Drehmechanismus
 Ejemplo la rotación por
 Exemple pour la rotation
 Esempio per la rotazione



Mini

Standard



Mini

Standard

CFS-13-740-07

CFS-13-741-07

CFS-13-742-07

CFS-13-743-07

x = 7 cm - 2 3/4"

CFS-13-740-09

CFS-13-741-09

CFS-13-742-09

CFS-13-743-09

x = 9 cm - 3 1/2"

CFS-13-740-11

CFS-13-741-11

CFS-13-742-11

CFS-13-743-11

x = 11 cm - 4 1/4"

non rotating
 nicht drehbar
 non rotatorio
 non rotatif
 non rotativo

rotating
 drehbar
 rotatorio
 rotatif
 rotativo



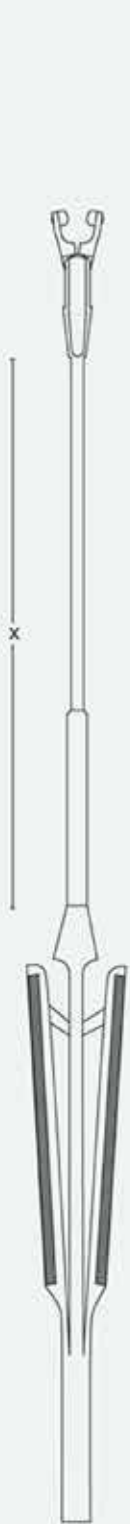

starr
rigid
rigide
rigido
rigido



Example for rotation
Beispiel für Drehmechanismus
Ejemplo la rotación por
Exemple pour la rotation
Esempio per la rotazione



Mini

Standard



Mini

Standard

CFS-13-744-07

CFS-13-745-07

CFS-13-746-07

CFS-13-747-07

x = 7 cm - 2 3/4"

CFS-13-744-09

CFS-13-745-09

CFS-13-746-09

CFS-13-747-09

x = 9 cm - 3 1/2"

CFS-13-744-11

CFS-13-745-11

CFS-13-746-11

CFS-13-747-11

x = 11 cm - 4 1/4"

non rotating
nicht drehbar
non rotatorio
non rotatif
non rotativo

rotating
drehbar
rotatorio
rotatif
rotativo

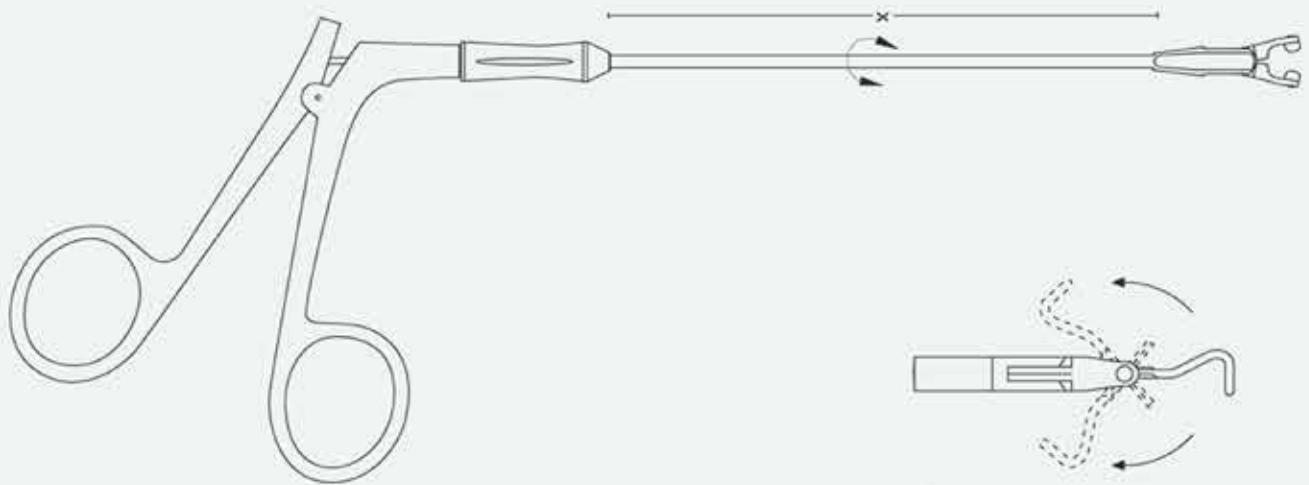

Shank rotatable
 Schaft drehbar
 Vaina giratoria
 Tige rotatif
 Asta girevole

Example for rotation
 Beispiel für Drehmechanismus
 Ejemplo la rotación por
 Exemple pour la rotation
 Esempio per la rotazione

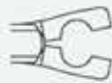

Mini	Standard	Mini	Standard	
CFS-13-748-07	CFS-13-749-07	CFS-13-750-07	CFS-13-751-07	x = 7 cm - 2 3/4"
CFS-13-748-09	CFS-13-749-09	CFS-13-750-09	CFS-13-751-09	x = 9 cm - 3 1/2"
CFS-13-748-11	CFS-13-749-11	CFS-13-750-11	CFS-13-751-11	x = 11 cm - 4 1/4"
CFS-13-748-13	CFS-13-749-13	CFS-13-750-13	CFS-13-751-13	x = 13 cm - 5"
non rotating nicht drehbar non rotatorio non rotatif non rotativo		rotating drehbar rotatorio rotatif rotativo		





Mini		Standard		
CFS-13-752-07	CFS-13-753-07	CFS-13-754-07	CFS-13-755-07	1.7 cm - 6 3/4"
CFS-13-752-08	CFS-13-753-08	CFS-13-754-08	CFS-13-755-08	1.8 cm - 7"
CFS-13-752-09	CFS-13-753-09	CFS-13-754-09	CFS-13-755-09	2.1 cm - 8 1/4"
CFS-13-752-10	CFS-13-756-10	CFS-13-754-10	CFS-13-755-10	2.3 cm - 9"

straight, with ratchet
 gerade, mit Sperre
 recta, con cierre
 droit, avec verrou
 retta, con cremagliera

bayonett shaped, with ratchet
 bayonett-förmig, mit Sperre
 forma bayoneta, con cierre
 en baionette, avec verrou
 forma baionetta, con cremagliera

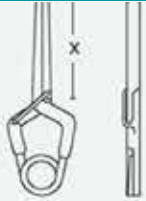

x = Jaw length	y = max. opening	gms = Pressure
x = Maullänge	y = max. Maulöffnung	gms = Schließkraft
x = Longitud de la boca	y = Apertura max. de la boca	gms = Presión
x = Longueur du mors	y = Ouverture max. du mors	gms = Force de fermeture
x = Lunghezza del morso	y = Apertura mass. del morso	gms = Sforza della chiusura

For titanium clips, please add a "T" to the reference number.

Bei Bestellung von Titan Clips, bitte der Artikelnummer ein „T“ hinzufügen.











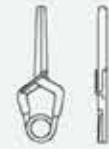







Para clips de titanio, por favor añadir und "T" a la referencia.

Pour des clips en titane, veuillez ajouter un «T» à la référence.

Per clips in titanio, per favore aggiungete al numero d'articolo un "T".

Yasargil-Standard

for permanent closure, in high quality implant steel, antimagnetic
für permanenten Verschluss, aus hochwertigem Implantatstahl, antimagnetisch
para oclusión permanente, acero de alta calidad, antimagnetico
pour fermeture permanente, acier de haute qualité, anti-magnétique
per chiusura permanente, acciaio di alta qualità, antimagnetico

						
CFS-13-756-00	CFS-13-757-00	CFS-13-758-00	CFS-13-759-00	CFS-13-760-00	CFS-13-761-00	CFS-13-762-00
x = 7.0 mm y = 6.2 mm gms = 150	x = 9.0 mm y = 7.0 mm gms = 180	x = 11.0 mm y = 7.8 mm gms = 180	x = 15.0 mm y = 9.2 mm gms = 200	x = 17.0 mm y = 10.6 mm gms = 200	x = 20.0 mm y = 11.4 mm gms = 200	x = 25.0 mm y = 13.3 mm gms = 200
						
CFS-13-763-00	CFS-13-764-00	CFS-13-765-00	CFS-13-766-00	CFS-13-767-00	CFS-13-768-00	CFS-13-769-00
x = 7.0 mm y = 6.0 mm gms = 150	x = 9.0 mm y = 6.8 mm gms = 180	x = 11.0 mm y = 7.5 mm gms = 180	x = 15.0 mm y = 8.7 mm gms = 200	x = 7.0 mm y = 5.5 mm gms = 150	x = 9.0 mm y = 6.1 mm gms = 180	x = 11.0 mm y = 6.5 mm gms = 180
						
CFS-13-770-00	CFS-13-771-00	CFS-13-772-00	CFS-13-773-00	CFS-13-774-00	CFS-13-775-00	
x = 15.0 mm y = 7.4 mm gms = 200	x = 7.0 mm y = 5.4 mm gms = 180	x = 9.0 mm y = 5.8 mm gms = 180	x = 11.0 mm y = 6.2 mm gms = 180	x = 7.0 mm y = 7.9 mm gms = 200	x = 9.0 mm y = 8.7 mm gms = 200	



x = Jaw length y = max. opening gms = Pressure
 x = Maullänge y = max. Maulöffnung gms = Schließkraft
 x = Longitud de la boca y = Apertura max. de la boca gms = Presión
 x = Longueur du mors y = Ouverture max. du mors gms = Force de fermeture
 x = Lunghezza del morso y = Apertura mass. del morso gms = Sforza della chiusura

For titanium clips, please add a "T" to the reference number.
 Bei Bestellung von Titan Clips, bitte der Artikelnummer ein „T“ hinzufügen.

Para clips de titanio, por favor añadir un "T" a la referencia.







Pour des clips en titane, veuillez ajouter un «T» à la référence.

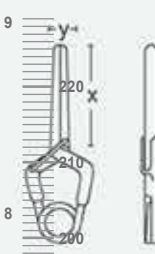





Per clips in titanio, per favore aggiungete al numero d'articolo un "T".





Yasargil-Standard

for permanent closure, in high quality implant steel, antimagnetic
 für permanenten Verschluss, aus hochwertigem Implantatstahl, antimagnetisch
 para oclusión permanente, acero de alta calidad, antimagnético
 pour fermeture permanente, acier de haute qualité, anti-magnétique
 per chiusura permanente, acciaio di alta qualità, antimagnetico

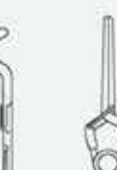

						
CFS-13-776-00	CFS-13-777-00	CFS-13-778-00	CFS-13-779-00	CFS-13-780-00	CFS-13-781-00	CFS-13-782-00
x = 12.0 mm y = 10.2 mm gms = 200	x = 17.0 mm y = 11.9 mm gms = 180	x = 20.0 mm y = 13.0 mm gms = 180	x = 5.0 mm y = 6.2 mm gms = 200	x = 7.0 mm y = 6.5 mm gms = 200	x = 9.0 mm y = 7.8 mm gms = 200	x = 11.0 mm y = 8.4 mm gms = 200

					
CFS-13-783-00	CFS-13-784-00	CFS-13-785-00	CFS-13-786-00	CFS-13-787-00	CFS-13-788-00
x = 5.0 mm y = 5.6 mm gms = 200	x = 7.0 mm y = 5.6 mm gms = 200	x = 10.0 mm y = 5.6 mm gms = 200	x = 8.0 mm y = 5.4 mm gms = 200	x = 10.0 mm y = 5.6 mm gms = 200	x = 5.0 mm y = 7.2 mm gms = 200

				
CFS-13-789-00	CFS-13-790-00	CFS-13-791-00	CFS-13-792-00	CFS-13-793-00
x = 9.0 mm y = 7.2 mm gms = 200	x = 11.0 mm y = 8.2 mm gms = 200	x = 7.0 mm y = 5.7 mm gms = 200	x = 11.0 mm y = 8.0 mm gms = 200	x = 9.0 mm y = 7.0 mm gms = 200

INCHES
MILLIMETERS

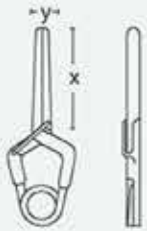

x = Jaw length	y = max. opening	gms = Pressure
x = Maullänge	y = max. Maulöffnung	gms = Schließkraft
x = Longitud de la boca	y = Apertura max. de la boca	gms = Presión
x = Longueur du mors	y = Ouverture max. du mors	gms = Force de fermeture
x = Lunghezza del morso	y = Apertura mass. del morso	gms = Sforza della chiusura

For titanium clips, please add a "T" to the reference number.

Bei Bestellung von Titan Clips, bitte der Artikelnummer ein „T“ hinzufügen.

Para clips de titanio, por favor añadir und "T" a la referencia.

Pour des clips en titane, veuillez ajouter un « T » à la référence.

Per clips in titanio, per favore aggiungete al numero d'articolo un "T".

Yasargil-Standard

for permanent closure, with window 3,5 mm, in high quality implant steel, antimagnetic
 für permanenten Verschluss, mit Fenster 3,5 mm, aus hochwertigem Implantatstahl, antimagnetisch
 para oclusión permanente, con finestra de 3,5 mm, acero de alta calidad, antimagnetico
 pour fermeture permanente, avec fenestra 3,5 mm, acier de haute qualité, anti-magnétique
 per chiusura permanente, con finestra di 3,5 mm, acciaio di alta qualita, antimagnetico

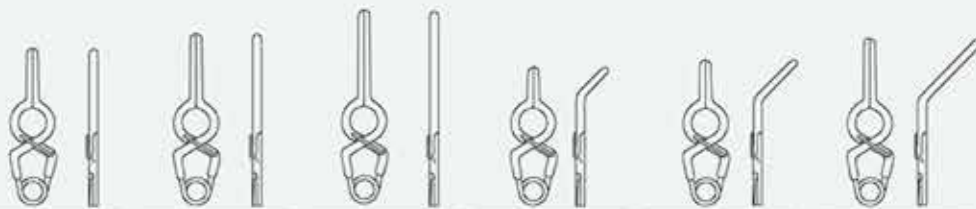

CFS-13-794-00	CFS-13-795-00	CFS-13-796-00	CFS-13-797-00	CFS-13-798-00	CFS-13-799-00
x = 7.0 mm	x = 9.0 mm	x = 12.0 mm	x = 5.0 mm	x = 7.0 mm	x = 11.0 mm
y = 7.4 mm	y = 8.4 mm	y = 9.6 mm	y = 5.8 mm	y = 6.5 mm	y = 7.2 mm
gms = 150	gms = 150	gms = 180	gms = 150	gms = 150	gms = 180



CFS-13-800-00	CFS-13-801-00	CFS-13-802-00
x = 5.0 mm	x = 7.0 mm	x = 11.0 mm
y = 4.9 mm	y = 4.9 mm	y = 4.9 mm
gms = 150	gms = 150	gms = 180



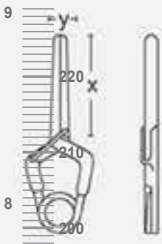

x = Jaw length	y = max. opening	gms = Pressure
x = Maullänge	y = max. Maulöffnung	gms = Schließkraft
x = Longitud de la boca	y = Apertura max. de la boca	gms = Presión
x = Longueur du mors	y = Ouverture max. du mors	gms = Force de fermeture
x = Lunghezza del morso	y = Apertura mass. del morso	gms = Sforza della chiusura

For titanium clips, please add a "T" to the reference number.

Bei Bestellung von Titan Clips, bitte der Artikelnummer ein „T“ hinzufügen.

Para clips de titanio, por favor añadir und "T" a la referencia.

Pour des clips en titane, veuillez ajouter un «T» à la référence.

Per clips in titanio, per favore aggiungete al numero d'articolo un "T".

Yasargil-Standard

for permanent closure, with window 3,5 mm, in high quality implant steel, antimagnetic
 für permanenten Verschluss, mit Fenster 3,5 mm, aus hochwertigem Implantatstahl, antimagnetisch
 para oclusión permanente, con ventana de 3,5 mm, acero de alta calidad, antimagnético
 pour fermeture permanente, avec fenestra 3,5 mm, acier de haute qualité, anti-magnétique
 per chiusura permanente, con finestra di 3,5 mm, acciaio di alta qualità, antimagnetico

CFS-13-803-00	CFS-13-804-00	CFS-13-805-00	CFS-13-806-00	CFS-13-807-00	CFS-13-808-00
x = 7.0 mm y = 7.9 mm gms = 150	x = 9.0 mm y = 9.1 mm gms = 150	x = 12.0 mm y = 10.3 mm gms = 180	x = 5.0 mm y = 6.5 mm gms = 150	x = 7.0 mm y = 7.2 mm gms = 150	x = 11.0 mm y = 7.8 mm gms = 180
CFS-13-809-00	CFS-13-810-00	CFS-13-811-00	CFS-13-812-00	CFS-13-813-00	CFS-13-814-00
x = 5.0 mm y = 5.5 mm gms = 150	x = 7.0 mm y = 5.5 mm gms = 150	x = 11.0 mm y = 5.5 mm gms = 180	x = 5.0 mm y = 7.9 mm gms = 150	x = 7.0 mm y = 8.8 mm gms = 150	x = 11.0 mm y = 10.0 mm gms = 180



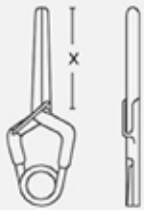

x = Jaw length	y = max. opening	gms = Pressure
x = Maullänge	y = max. Maulöffnung	gms = Schließkraft
x = Longitud de la boca	y = Apertura max. de la boca	gms = Presión
x = Longueur du mors	y = Ouverture max. du mors	gms = Force de fermeture
x = Lunghezza del morso	y = Apertura mass. del morso	gms = Sforza della chiusura

For titanium clips, please add a "T" to the reference number.

Bei Bestellung von Titan Clips, bitte der Artikelnummer ein „T“ hinzufügen.

Para clips de titanio, por favor añadir un "T" a la referencia.

Pour des clips en titane, veuillez ajouter un «T» à la référence.

Per clips in titanio, per favore aggiungete al numero d'articolo un "T".

Yasargil-Standard

for permanent closure, with window 5.0 mm, in high quality implant steel, antimagnetic
für permanenten Verschluss, mit Fenster 5.0 mm, aus hochwertigem Implantatstahl, antimagnetisch
para oclusión permanente, con ventana de 5.0 mm, acero de alta calidad, antimagnetico
pour fermeture permanente, avec fenestra 5.0 mm, acier de haute qualité, anti-magnétique
per chiusura permanente, con finestra di 5.0 mm, acciaio di alta qualità, antimagnetico



CFS-13-815-00 x = 5.0 mm y = 5.8 mm gms = 150	CFS-13-816-00 x = 7.0 mm y = 5.8 mm gms = 150	CFS-13-817-00 x = 10.0 mm y = 5.8 mm gms = 150	CFS-13-818-00 x = 5.0 mm y = 5.8 mm gms = 150	CFS-13-819-00 x = 7.0 mm y = 5.8 mm gms = 150	CFS-13-820-00 x = 10.0 mm y = 5.8 mm gms = 150
---	---	--	---	---	--



CFS-13-821-00 x = 5.0 mm y = 7.0 mm gms = 150	CFS-13-822-00 x = 7.0 mm y = 7.8 mm gms = 150	CFS-13-823-00 x = 10.0 mm y = 8.8 mm gms = 150	CFS-13-824-00 x = 5.0 mm y = 5.8 mm gms = 150	CFS-13-825-00 x = 7.0 mm y = 6.2 mm gms = 150	CFS-13-826-00 x = 5.0 mm y = 5.8 mm gms = 150	CFS-13-827-00 x = 7.0 mm y = 6.2 mm gms = 150
---	---	--	---	---	---	---



CFS-13-828-00 x = 5.0 mm y = 5.6 mm gms = 150	CFS-13-829-00 x = 7.0 mm y = 5.6 mm gms = 150	CFS-13-830-00 x = 5.0 mm y = 5.6 mm gms = 150	CFS-13-831-00 x = 7.0 mm y = 5.6 mm gms = 150
---	---	---	---



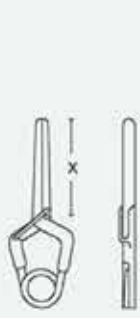
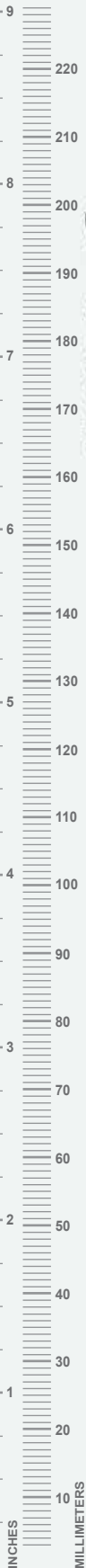

x = Jaw length	y = max. opening	gms = Pressure
x = Maullänge	y = max. Maulöffnung	gms = Schließkraft
x = Longitud de la boca	y = Apertura max. de la boca	gms = Presión
x = Longueur du mors	y = Ouverture max. du mors	gms = Force de fermeture
x = Lunghezza del morso	y = Apertura mass. del morso	gms = Sforza della chiusura

For titanium clips, please add a "T" to the reference number.
Bei Bestellung von Titan Clips, bitte der Artikelnummer ein „T“ hinzufügen.
Para clips de titanio, por favor añadir und "T" a la referencia.
Pour des clips en titane, veuillez ajouter un «T» à la référence.
Per clips in titanio, per favore aggiungete al numero d'articolo un "T".

Yasargil-Standard

for permanent closure, in high quality implant steel, antimagnetic
für permanenten Verschluss, aus hochwertigem Implantatstahl, antimagnetisch
para oclusión permanente, acero de alta calidad, antimagnetico
pour fermeture permanente, acier de haute qualité, anti-magnétique
per chiusura permanente, acciaio di alta qualita, antimagnetico

CFS-13-832-00	CFS-13-833-00	CFS-13-834-00	CFS-13-835-00	CFS-13-836-00	CFS-13-837-00	CFS-13-838-00
x = 9.0 mm	x = 9.0 mm	x = 9.0 mm	x = 15.0 mm	x = 15.0 mm	x = 15.0 mm	x = 9.0 mm
y = 7.0 mm	y = 6.8 mm	y = 6.1 mm	y = 9.2 mm	y = 8.7 mm	y = 7.4 mm	y = 6.2 mm
gms = 90	gms = 90	gms = 110	gms = 90	gms = 110	gms = 110	gms = 110

CFS-13-839-00	CFS-13-840-00	CFS-13-841-00	CFS-13-842-00
x = 20.0 mm	x = 20.0 mm	x = 17.0 mm	x = 13.0 mm
y = 11.4 mm	y = 11.0 mm	y = 9.9 mm	y = 7.5 mm
gms = 110	gms = 90	gms = 90	gms = 90

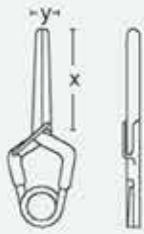

x = Jaw length
 x = Maullänge
 x = Longitud de la boca
 x = Longueur du mors
 x = Lunghezza del morso





















y = max. opening
 y = max. Maulöffnung
 y = Apertura max. de la boca
 y = Ouverture max. du mors
 y = Apertura mass. del morso

gms = Pressure
 gms = Schließkraft
 gms = Presión
 gms = Force de fermeture
 gms = Sforza della chiusura

For titanium clips, please add a "T" to the reference number.
 Bei Bestellung von Titan Clips, bitte der Artikelnummer ein „T“ hinzufügen.
 Para clips de titanio, por favor añadir und "T" a la referencia.
 Pour des clips en titane, veuillez ajouter un «T» à la référence.
 Per clips in titanio, per favore aggiungete al numero d'articolo un "T".

Yasargil-Mini

for permanent closure, in high quality implant steel, antimagnetic
 für permanenten Verschluss, aus hochwertigem Implantatstahl, antimagnetisch
 para oclusión permanente, acero de alta calidad, antimagnetico
 pour fermeture permanente, acier de haute qualité, anti-magnétique
 per chiusura permanente, acciaio di alta qualita, antimagnetico

						
CFS-13-843-00	CFS-13-844-00	CFS-13-845-00	CFS-13-846-00	CFS-13-847-00	CFS-13-848-00	CFS-13-849-00
x = 3.0 mm y = 3.3 mm gms = 110	x = 5.0 mm y = 4.0 mm gms = 110	x = 3.0 mm y = 3.3 mm gms = 110	x = 5.0 mm y = 4.0 mm gms = 110	x = 7.0 mm y = 4.6 mm gms = 110	x = 3.0 mm y = 3.2 mm gms = 110	x = 4.0 mm y = 3.8 mm gms = 110
						
CFS-13-850-00	CFS-13-851-00	CFS-13-852-00	CFS-13-853-00	CFS-13-854-00	CFS-13-855-00	CFS-13-856-00
x = 4.0 mm y = 3.6 mm gms = 110	x = 5.0 mm y = 3.8 mm gms = 110	x = 4.0 mm y = 3.6 mm gms = 110	x = 5.0 mm y = 4.0 mm gms = 110	x = 7.0 mm y = 4.4 mm gms = 110	x = 4.0 mm y = 3.6 mm gms = 110	x = 4.0 mm y = 3.5 mm gms = 110
						
CFS-13-857-00	CFS-13-858-00	CFS-13-859-00	CFS-13-860-00	CFS-13-861-00	CFS-13-862-00	
x = 5.0 mm y = 4.0 mm gms = 110	x = 5.0 mm y = 3.5 mm gms = 130	x = 6.0 mm y = 3.5 mm gms = 130	x = 4.0 mm y = 7.0 mm gms = 130	x = 7.0 mm y = 5.7 mm gms = 130	x = 7.0 mm y = 4.5 mm gms = 130	





x = Jaw length	y = max. opening	gms = Pressure
x = Maullänge	y = max. Maulöffnung	gms = Schließkraft
x = Longitud de la boca	y = Apertura max. de la boca	gms = Presión
x = Longueur du mors	y = Ouverture max. du mors	gms = Force de fermeture
x = Lunghezza del morso	y = Apertura mass. del morso	gms = Sforza della chiusura

Yasargil-Mini

for temporary closure, in high quality implant steel, antimagnetic
 für temporären Verschluss, aus hochwertigem Implantatstahl, antimagnetisch
 para oclusión temporal, acero de alta calidad, antimagnetico
 pour fermeture temporaire, acier de haute qualité, anti-magnétique
 per chiusura temporanea, acciaio di alta qualita, antimagnetico







For titanium clips, please add a "T" to the reference number.

Bei Bestellung von Titan Clips, bitte der Artikelnummer ein „T“ hinzufügen.

Para clips de titanio, por favor añadir und "T" a la referencia.

Pour des clips en titane, veuillez ajouter un «T» à la référence.

Per clips in titanio, per favore aggiungete al numero d'articolo un "T".

					
CFS-13-863-00	CFS-13-864-00	CFS-13-865-00	CFS-13-866-00	CFS-13-867-00	CFS-13-868-00
x = 3.0 mm	x = 5.0 mm	x = 4.0 mm	x = 7.0 mm	x = 7.0 mm	x = 5.0 mm
y = 3.3 mm	y = 4.0 mm	y = 3.8 mm	y = 4.6 mm	y = 4.4 mm	y = 4.0 mm
gms = 90	gms = 70	gms = 70	gms = 70	gms = 70	gms = 70



Scoville
CFS-13-869-23
23 cm - 9"
x = 8 mm



Holsher
CFS-13-870-24
24 cm - 9 1/2"
x = 7 mm



Scoville
CFS-13-871-20
20 cm - 8"
x = 7 mm

Martin
CFS-13-872-21
21 cm - 8 1/4"
x = 7 mm



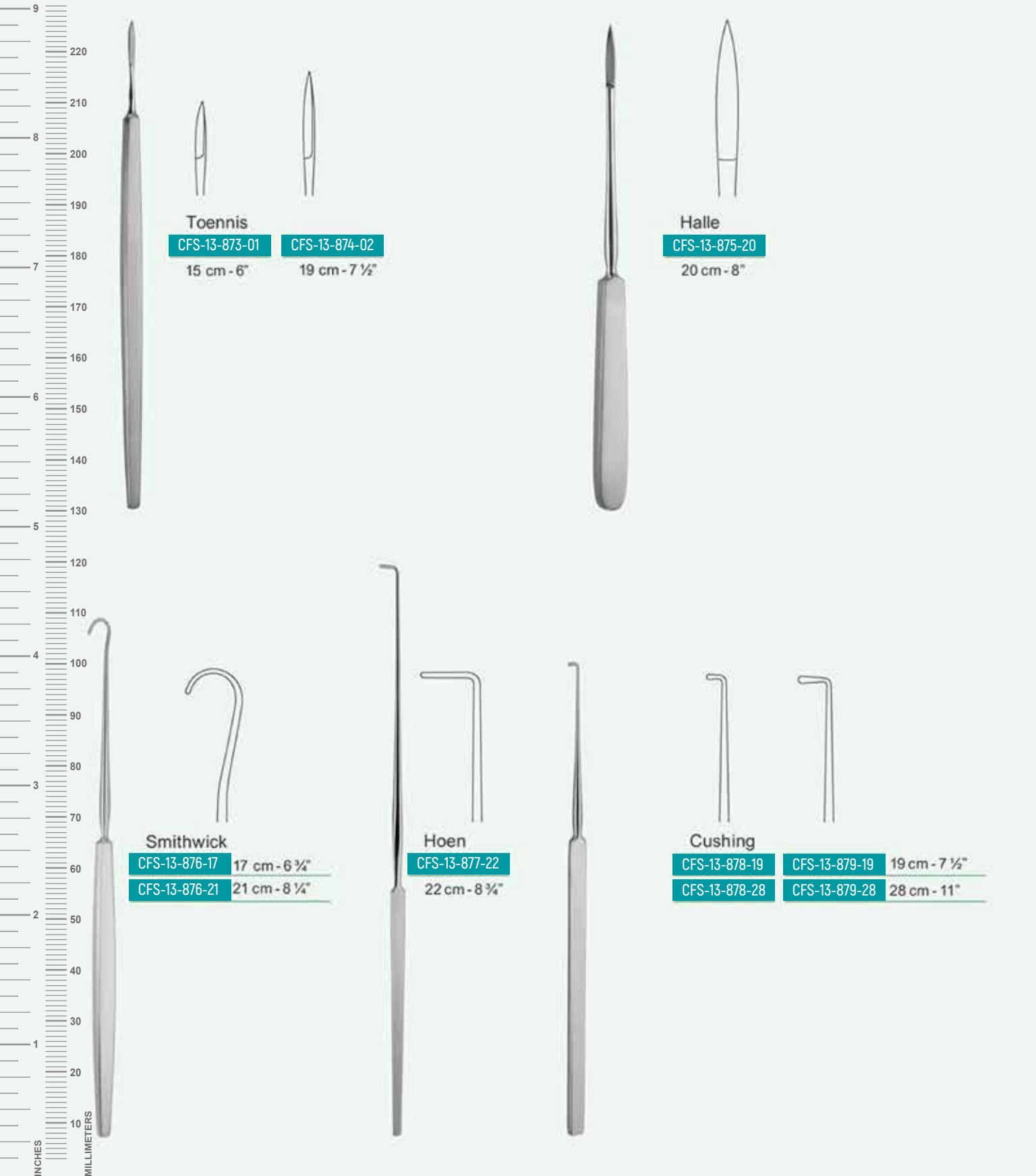

Toennis
 CFS-13-873-01 15 cm - 6"
 CFS-13-874-02 19 cm - 7 1/2"

Halle
 CFS-13-875-20 20 cm - 8"

Smithwick
 CFS-13-876-17 17 cm - 6 3/4"
 CFS-13-876-21 21 cm - 8 1/4"

Hoen
 CFS-13-877-22 22 cm - 8 3/4"

Cushing
 CFS-13-878-19 19 cm - 7 1/2"
 CFS-13-879-19 19 cm - 7 1/2"
 CFS-13-878-28 28 cm - 11"
 CFS-13-879-28 28 cm - 11"



Sachs
CFS-13-880-18
 18.5 cm - 7 1/4"

Graham
CFS-13-881-18
 18.5 cm - 7 1/4"

Frazier
CFS-13-882-17
 17 cm - 6 3/4"

Crile
CFS-13-883-01
 Fig. 1
 20 cm - 8"

CFS-13-883-02
 Fig. 2
 20 cm - 8"



Toennis
CFS-13-885-15
 15 cm - 6"

Dandy
CFS-13-886-20
 Fig. 1
 20 cm - 8"

CFS-13-887-20
 Fig. 2
 20 cm - 8"

CFS-13-888-20
 Fig. 3
 20 cm - 8"

Adson
CFS-13-889-20
 Fig. 1

CFS-13-890-20
 Fig. 2
 20 cm - 8"



9
220
210
8
200
190
7
180
170
6
160
150
5
140
130
120
110
4
100
90
3
80
70
2
60
50
1
40
30
10
INCHES
MILLIMETERS



Love
CFS-13-891-19 CFS-13-892-19 CFS-13-893-19 19 cm - 7 1/2"
Fig. 1 Fig. 2 Fig. 3



Yasargil
CFS-13-894-31 31 cm - 12 1/4"
CFS-13-894-41 41 cm - 16 1/4"
Galea retractor
Galeahaken
Retractor de Galea
Retracteur Galea
Retrottore di Galea



Cushing
CFS-13-895-14
14 cm - 5 1/2"



Frazier
CFS-13-896-13 CFS-13-897-13 13 cm - 5"
CFS-13-896-18 CFS-13-897-18 18 cm - 7"
sharp
spitz
agudo
pointu
acuto
blunt
stumpf
romos
mousse
smusso



Lahey
CFS-13-898-01
13 cm - 5"



Zöllner

90°

CFS-13-899-01

Roundknife, angledup
Rundschnittmesser, nach oben gebogen
Cuchillo redondo, angulado arriba
Coureau rond, coudé en haut
Coltello rotondo, angolato in alto



90°

CFS-13-900-00

Roundknife, angleddown
Rundschnittmesser, nach unten gebogen
Cuchillo redondo, angulado a bajo
Coureau rond, coudé en bas
Coltello rotondo, angolato in basso



CFS-13-901-00

Sickleknife, angledup
Sichelmesser, nach oben gebogen
Cuchillo de hoz, angulado arriba
Coureau faucille, courbe vers le haut
Coltello a forma di falce, angolato in alto



CFS-13-902-01

Sickleknife, angleddown
Sichelmesser, nach unten gebogen
Cuchillo de hoz, angulado a bajo
Coureau faucille, courbe vers le bas
Coltello a forma di falce, curvato in basso



CFS-13-903-00

Lancetknife, curved to left
Lanzenmesser, links gebogen
Cuchillo lanceolado, angulado a la izquierda
Coureau lancéolaire, courbe à gauche
Coltello lancelato, curvato a sinistra



CFS-13-904-00

Lancetknife, curved to right
Lanzenmesser, rechts gebogen
Cuchillo lanceolado, angulado a la derecha
Coureau lancéolaire, courbe à droite
Coltello lancelato, curvato a destra



CFS-13-905-01

Raspatory, curved to left
Raspatorium, links gebogen
Raspatorio, angulado a la izquierda
Décolleur, courbe à gauche
Raspatorio, curvato a sinistra



CFS-13-906-00

Raspatory, curved to right
Raspatorium, rechts gebogen
Raspatorio, angulado a la derecha
Décolleur, courbe à droite
Raspatorio, curvato a destra



CFS-13-907-00

Wire guide
Führungsgabel
Tenedor guía
Fourchette d'introduction
Forchetta guida





Sachs
 CFS-13-908-21 CFS-13-909-21 CFS-13-910-21 21cm-8 1/4"

Horsley
 CFS-13-911-20
 20cm-8"

Smithwick
 CFS-13-912-29
 29cm-11 1/2"

Penfield
 CFS-13-913-17
 Fig.1
 17.5cm-7"

CFS-13-914-19
 Fig.2
 19.5cm-7 3/4"

CFS-13-915-19
 Fig.3
 19.5cm-7 3/4"

CFS-13-916-21
 Fig.4
 21.5cm-8 1/2"

CFS-13-917-18
 Fig.5
 18.5cm-7 3/4"

INCHES
 MILLIMETERS



Yasargil

CFS-13-918-19

straight
gerade
recta
droit
rette



CFS-13-919-19



CFS-13-920-19



CFS-13-921-19



CFS-13-922-19

19 cm - 7 1/2"

CFS-13-923-19

bayonet
bajonett
bayoneta
baionette
baionetta

CFS-13-924-19

CFS-13-925-19

CFS-13-926-19

CFS-13-927-19

19 cm - 7 1/2"



Yasargil

CFS-13-928-19

straight
gerade
recta
droit
rette



CFS-13-929-19



CFS-13-930-19



CFS-13-931-19

19 cm - 7 1/2"

CFS-13-932-22

bayonet
bajonett
bayoneta
baionette
baionetta

CFS-13-933-22

CFS-13-934-22

CFS-13-935-22

19 cm - 7 1/2"



CFS-13-936-22



CFS-13-937-22

19 cm - 7 1/2"

straight, with Twist-fixationhook
gerade, mit Dreh-Fixerhaken
recta, con gancho de fijación
droit, avec crochet de fixation
rette, con uncino di fissaggio "Twist"



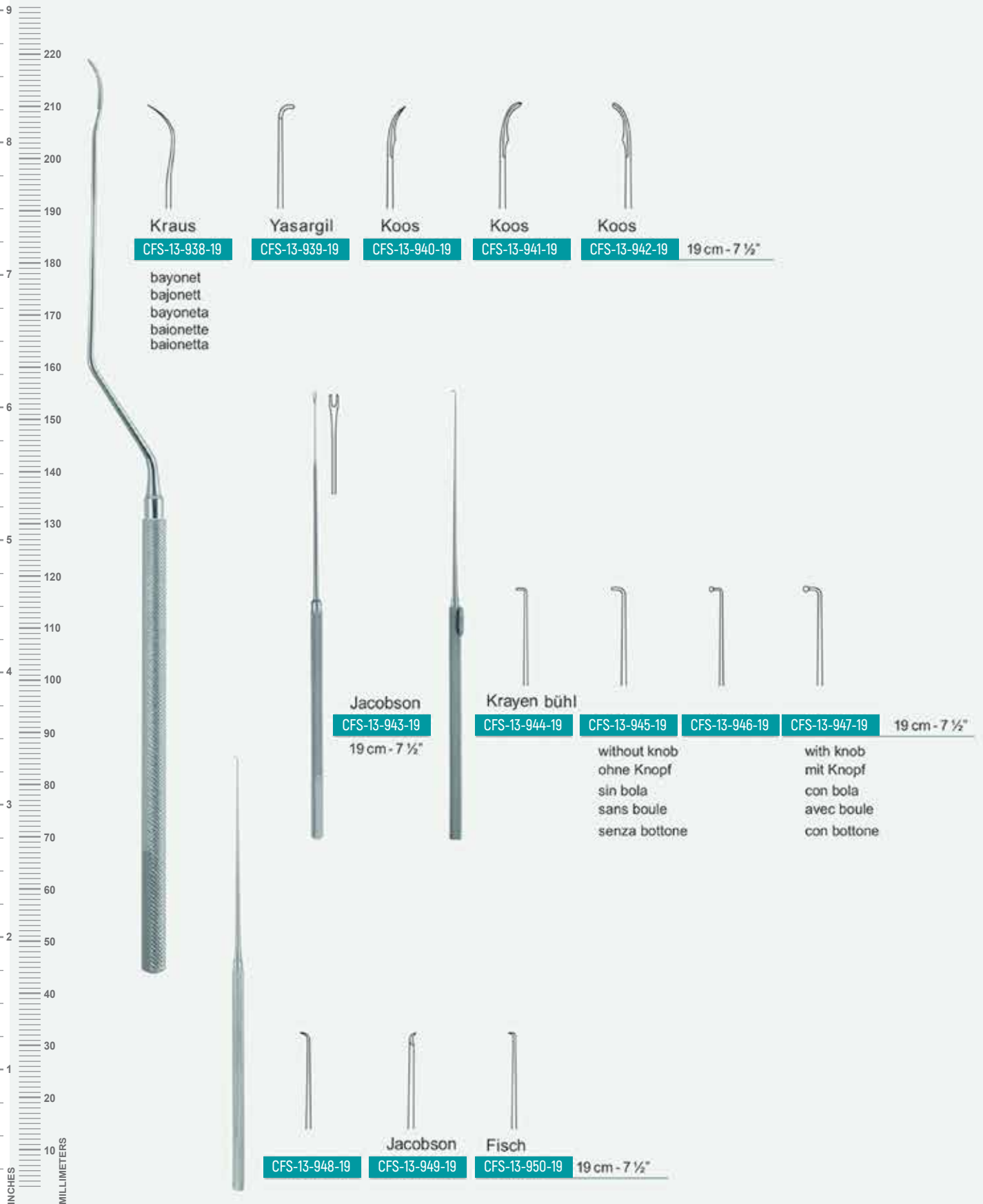

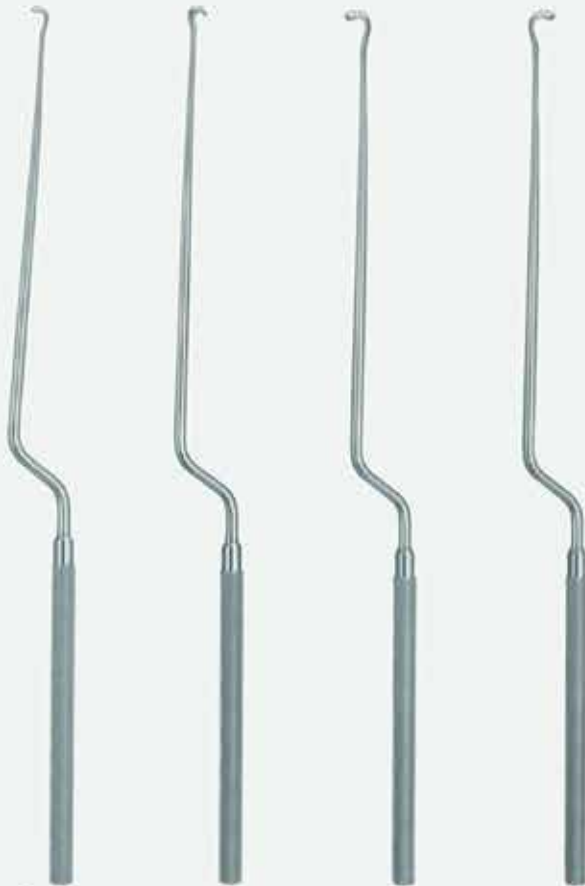

Hardy

CFS-13-951-25 CFS-13-952-25 CFS-13-953-25 CFS-13-954-25

25 cm - 9 3/4" 25 cm - 9 3/4" 25 cm - 9 3/4" 25 cm - 9 3/4"

bayonet, sharp inner edge
bajonett, innen scharf
bayoneta, cortante al interno
baionette, tranchant à l'interno
baionetta, acuto all'interno



Hardy

CFS-13-955-27 CFS-13-956-27 27 cm - 10 3/4"

4 mmØ 6 mmØ

bayonet, malleable
bajonett, biegsam
bayoneta, maleable
baionette, malléable
baionetta, flessibile



Vannas

CFS-13-957-08 CFS-13-958-08 8 cm - 3 1/4"

Vannas-Schneide
 Vannas-blade
 Lame de Vannas
 Hoja de Vannas
 Lama Vannas



Welsh

CFS-13-959-12 CFS-13-960-12 12 cm - 4 3/4"

straight
 gerade
 recta
 droite
 retta

curved
 gebogen
 curva
 courbe
 curva

Blade 10 mm, sharp
 Schneide 10 mm, spitz
 Hoja 10 mm, agudas
 Lame 10 mm, pointu
 Lama 10 mm, acuta

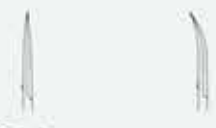

CFS-13-961-12 CFS-13-962-12 CFS-13-963-12 12 cm - 4 3/4"

straight
 gerade
 recta
 droite
 retta

curved
 gebogen
 curva
 courbe
 curva

angled up
 aufgewinkelt
 acodada
 angulaire
 angolata

Vannas-blade
 Vannas-Schneide
 Hoja de Vannas
 Lame de Vannas
 Lama de Vannas



CFS-13-964-12 12 cm - 4 3/4"

straight
 gerade
 recta
 droite
 retta

Vein-blade (Biemer)
 Venen-Schneide (Biemer)
 Hoja para venas (Biemer)
 Lame pour vènes (Biemer)
 Lama per vene (Biemer)





Weish

CFS-13-965-15

CFS-13-965-18

straight, short blades
gerade, kurze Schneide
recta, hojas cortas
droites, lames courtes
retta, lama corta



CFS-13-966-15

CFS-13-966-18

curved, short blades
gebogen, kurze Schneide
curva, hojas cortas
courbes, lames courtes
curva, lama corta



CFS-13-967-15

CFS-13-967-18

straight, long blades
gerade, lange Schneide
recta, hojas largas
droites, lames longues
retta, lama lunga



CFS-13-968-15 15 cm - 6"

CFS-13-968-18 18 cm - 7"

curved, long blades
gebogen, lange Schneide
curva, hojas largas
courbes, lames longues
curva, lama lunga



CFS-13-969-15

CFS-13-969-18

straight, saw edge
gerade, gezahnt
recta, dentadas
droites, dentelés
retta, dentata



CFS-13-970-15

CFS-13-970-18

curved, saw edge
gebogen, gezahnt
curva, dentadas
courbes, dentelés
curva, dentata



CFS-13-971-15 15 cm - 6"

CFS-13-971-18 18 cm - 7"

angled on flat, 45°
kniegebogen, 45°
acodada, 45°
angulaires, 45°
angolata, 45°



Yasargil

CFS-13-972-18

straight
gerade
recta
droits
retta



CFS-13-973-18

curved
gebogen
curva
courbes
curva



CFS-13-974-18 18.5 cm - 7 1/4"

angled on flat
kniegebogen
acodada
angulaires
angolata



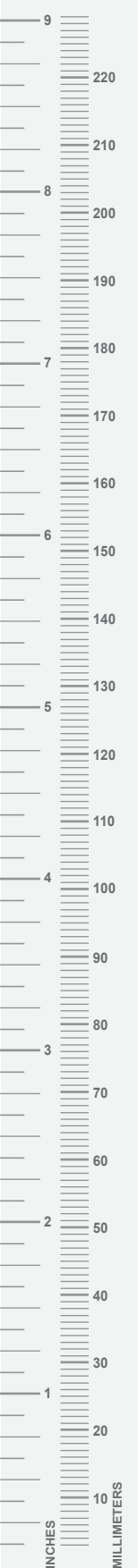

Welsh
CFS-13-975-12
straight
gerade
recta
droites
retta



CFS-13-976-12 12cm - 4 3/4"
curved
gebogen
curva
courbes
curva
Long blades 14 mm, smooth, sharp
Lange Schneide 14 mm, glatt, spitz
Hojas largas 14 mm, lisas, agudas
Lama lunga 14 mm, liscia, acuta
Lames longues 14 mm, lisses, pointues



CFS-13-977-12
straight, saw edge
gerade, gezahnt
recta, dentadas
droites, dentelés
retta, dentata



CFS-13-978-12 12cm - 4 3/4"
curved, saw edge
gebogen, gezahnt
curva, dentadas
courbes, dentelés
curva, dentata
Long blades 14 mm, sharp
Lange Schneide 14 mm, spitz
Hojas largas 14 mm, agudas
Lames longues 14 mm, pointues
Lama lunga 14 mm, acuta



CFS-13-979-14
straight
gerade
recta
droits
retta



CFS-13-980-14 14.5 cm - 5 3/4"
curved
gebogen
curva
courbes
curva
Vannas-blades, smooth, sharp
Vannas-Schneide, glatt, spitz
Hojas de Vannas, lisas, agudas
Lames de Vannas, lisses, pointues
Vannas-lama, liscia, acuta



Yasargil

CFS-13-981-17

CFS-13-982-17

CFS-13-983-17

CFS-13-984-17

CFS-13-985-17

17 cm - 6 1/4"

25°

45°

60°

90°

125°

with ball
 mit Knopf
 con botón
 avec bouton
 con bottone



Yasargil

CFS-13-986-17

CFS-13-987-17

CFS-13-988-17

CFS-13-988-17

CFS-13-990-17

17 cm - 6 1/4"

25°

45°

60°

90°

125°

without ball
 mit ohne Knopf
 sin bola botón
 sans boule bouton
 con senza bottone





Irwan

CFS-13-991-14

CFS-13-991-18

straight, sharp
gerade, spitz
rectas, agudas
droites, pointues
retta, acuta



CFS-13-992-14

CFS-13-992-18

curved, sharp
gebogen, spitz
curvas, agudas
courbes, pointues
curva, acuta



CFS-13-993-14

CFS-13-993-18

straight, blunt
gerade, stumpf
rectas, romas
droites, mousses
retta, smussa



CFS-13-994-14

CFS-13-994-18

curved, blunt
gebogen, stumpf
curvas, romas
courbes, mousses
curva, smussa

14.5 cm 5 3/4"

18 cm - 7"

short blades 8 mm, smooth
kurze Schneide 8 mm, glatt
hojas cortas 8 mm, lisos
lames courtes 8 mm, lisses
lama corta 8 mm, liscia



CFS-13-995-14

CFS-13-995-18

straight, sharp
gerade, spitz
rectas, agudas
droites, pointues
retta, acuta



CFS-13-996-14

CFS-13-996-18

curved, sharp
gebogen, spitz
curvas, agudas
courbes, pointues
curva, acuta



CFS-13-997-14

CFS-13-997-18

straight, blunt
gerade, stumpf
rectas, romas
droites, mousses
retta, smussa



CFS-13-998-14

CFS-13-998-18

curved, blunt
gebogen, stumpf
curvas, romas
courbes, mousses
curva, smussa

14.5 cm 5 3/4"

18 cm - 7"

long blades 14 mm, smooth
lange Schneide 14 mm, glatt
hojas largas 14 mm, lisos
lames longues 14 mm, lisses
lama lunga 14 mm, liscia



Vannas

CFS-13-999-12

12 cm - 5"

7 mm Ø

CFS-13-100-12

12 cm - 5"

7 mm Ø

Vannas

CFS-13-101-15

15 cm - 6"

8 mm Ø

CFS-13-102-15

15 cm - 6"

8 mm Ø



Castroviejo

CFS-13-103-15

8 mm Ø

CFS-13-104-15

8 mm Ø

15 cm - 6"



Irwan

CFS-13-105-08

18 cm - 7"

sharp/sharp

CFS-13-106-08

18 cm - 7"

sharp/sharp

CFS-13-107-08

18 cm - 7"

sharp/blunt

CFS-13-108-08

18 cm - 7"

sharp/blunt

CFS-13-109-08

18 cm - 7"

blunt/blunt

CFS-13-110-08

18 cm - 7"

blunt/blunt

8 mm Ø

CFS-13-105-10

18 cm - 7"

10 mm Ø

CFS-13-106-10

18 cm - 7"

CFS-13-107-18

18 cm - 7"

CFS-13-108-18

18 cm - 7"

CFS-13-109-18

18 cm - 7"

CFS-13-110-18

18 cm - 7"





Irwan Pro

CFS-13-111-17

CFS-13-112-17

CFS-13-113-17

CFS-13-114-17

CFS-13-115-17

17 cm - 6 3/4"

25°

45°

60°

90°

125°

8 mmØ

Blade 10 mm, with ball, sharp
 Schneide 10 mm, mit Knopf, spitz
 Hojas 10 mm, con botón, agudas
 Lames 10 mm, avec bouton, pointues
 Lama 10 mm, con bottone, acuta



CFS-13-116-18

CFS-13-117-18

CFS-13-118-18

CFS-13-119-18

CFS-13-120-18

18 cm - 7"

25°

45°

60°

90°

125°

8 mmØ

Blade 10 mm, without ball, sharp
 Schneide 10 mm, ohne Knopf, spitz
 Hojas 10 mm, sin botón, agudas
 Lames 10 mm, sans bouton, pointues
 Lama 10 mm, senza bottone, acuta



Irwan Pro

CFS-13-121-18

CFS-13-122-18

CFS-13-123-18

CFS-13-124-18

CFS-13-125-18

18 cm 7"

25°

45°

60°

90°

125°

8 mmØ

with ball
 mit Knopf
 con botón
 avec bouton
 con bottone



CFS-13-126-18

CFS-13-127-18

CFS-13-128-18

CFS-13-129-18

CFS-13-130-18

18 cm 7"

25°

45°

60°

90°

125°

8 mmØ

without ball
 ohne Knopf
 sin botón
 sans bouton
 senza bottone



Dylex

CFS-13-131-15

CFS-13-132-15

15 cm - 6"

9 mmØ

9 mmØ





Jacobson

CFS-13-133-16
CFS-13-133-18

straight
gerade
recta
droits
retta



CFS-13-134-16
CFS-13-134-18

curved
gebogen
curva
courbes
curva



CFS-13-135-16
CFS-13-135-18

angled, 45°
abgewinkelt, 45°
acodada, 45°
angulaires, 45°
angolata, 45°



CFS-13-136-16
CFS-13-136-18

Vannas blade
Vannas Schneide
Hoja de Vannas
Lame de Vannas
Lama Vannas



CFS-13-137-16
CFS-13-137-18



Yasargil-mod.

CFS-13-139-16
CFS-13-139-18

CFS-13-140-16
CFS-13-140-18

CFS-13-141-22



CFS-13-140-16
CFS-13-140-18

CFS-13-140-18
CFS-13-140-18



CFS-13-142-22

Vannas blade
Vannas Schneide
Hoja de Vannas
Lame de Vannas
Lama Vannas





Yasargil

CFS-13-143-20

CFS-13-143-22

straight
gerade
recta
droits
retta



CFS-13-144-20

CFS-13-144-22

curved
gebogen
curva
courbes
curva



CFS-13-145-20

CFS-13-145-22

straight, saw edge
gerade, gezahnt
recta, dentadas
droits, dentelées
retta, dentata



CFS-13-146-20

CFS-13-146-22

curved, saw edge
gebogen, gezahnt
curva, dentadas
courbes, dentelées
curva, dentata

20 cm - 8"

22. cm - 8 3/4"

Blade smooth, sharp
Schneide glatt, spitz
Hojas lisas, agudas
Lames lisses, pointues
Lama liscia, acuta



CFS-13-147-20

CFS-13-147-22

Vannas blade
Vannas Schneide
Hoja de Vannas
Lame de Vannas
Lama Vannas



CFS-13-148-20

CFS-13-148-22

20 cm - 8"

22. cm - 8 3/4"



CFS-13-149-20

CFS-13-149-22

Dissector blade, blunt
Präparier-Schneide, stumpf
Hojas de disección, roma
Lames de dissction, moussé
Lama da dissezione, smussa



CFS-13-150-20

CFS-13-150-22

20 cm - 8"

22. cm - 8 3/4"





Pierse

CFS-13-156-12	12 cm - 4 ¾"
CFS-13-156-13	13.5 cm - 5 ¼"



Sholm

CFS-13-157-11
 x = 0.2 mm
 very fine
 sehr fein
 muy fino
 très fin
 molto fino



CFS-13-158-11	11 cm - 4 ¼"
---------------	--------------

x = 0.3 mm







Lazar

CFS-13-159-15

15.5 cm - 6"
0.5 mm

CFS-13-160-15

15.5 cm - 6"
0.8 mm

			
9 mm Ø	9 mm Ø	9 mm Ø	9 mm Ø
Lester			
CFS-13-161-18	CFS-13-162-18	CFS-13-163-18	CFS-13-164-18
		1x2	1x2

Tying platform 6.0 mm x 0.4 mm, smooth
Fadenplatte 6,0 mm x 0,4 mm, glatt
Plataforma 6.0 mm x 0.4 mm, lisa
Plate-forme 6.0 mm x 0.4 mm, lisse
Piano per sutura 6.0 mm x 0.4 mm, liscio

9 mm Ø	9 mm Ø	9 mm Ø	9 mm Ø
CFS-13-165-18	CFS-13-166-18	CFS-13-167-18	CFS-13-168-18
		1x2	1x2

Tying platform 6.0 mm x 0.4 mm, diamond coated
Fadenplatte 6,0 mm x 0,4 mm, diamantiert
Plataforma 6.0 mm x 0.4 mm, diamantada
Plate-forme 6.0 mm x 0.4 mm, diamanté
Piano per sutura 6.0 mm x 0.4 mm, diamantata

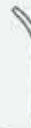
			
9 mm Ø	9 mm Ø	9 mm Ø	9 mm Ø
CFS-13-169-18	CFS-13-170-18	CFS-13-171-18	CFS-13-172-18
		1x2	1x2

Tying platform 6.0 mm x 0.8 mm, smooth
Fadenplatte 6,0 mm x 0,8 mm, glatt
Plataforma 6.0 mm x 0.8 mm, lisa
Plate-forme 6.0 mm x 0.8 mm, lisse
Piano per sutura 6.0 mm x 0.8 mm, liscio

9 mm Ø	9 mm Ø	9 mm Ø	9 mm Ø
CFS-13-173-18	CFS-13-174-18	CFS-13-175-18	CFS-13-176-18
		1x2	1x2

Tying platform 6.0 mm x 0.8 mm, diamond coated
Fadenplatte 6,0 mm x 0,8 mm, diamantiert
Plataforma 6.0 mm x 0.8 mm, diamantada
Plate-forme 6.0 mm x 0.8 mm, diamanté
Piano per sutura 6.0 mm x 0.8 mm, diamantata





Lester

CFS-13-177-15	CFS-13-178-15	CFS-13-179-15	CFS-13-180-15	15 cm - 6"
CFS-13-177-18	CFS-13-178-18	CFS-13-179-18	CFS-13-180-18	18 cm - 7"
CFS-13-177-21	CFS-13-178-21	CFS-13-179-21	CFS-13-180-21	21 cm - 8 ¼"
CFS-13-177-23	CFS-13-178-23	CFS-13-179-23	CFS-13-180-23	23 cm - 9"

0.3 mm 0.3 mm 0.7 mm 0.7 mm 8 mmØ

Jaw smooth
Maul glatt
Boca lisa
Mors lisse
Morso liscio

CFS-13-181-15	CFS-13-182-15	CFS-13-183-15	CFS-13-184-15	15 cm - 6"
CFS-13-181-18	CFS-13-182-18	CFS-13-183-18	CFS-13-184-18	18 cm - 7"
CFS-13-181-21	CFS-13-182-21	CFS-13-183-21	CFS-13-184-21	21 cm - 8 ¼"
CFS-13-181-23	CFS-13-182-23	CFS-13-183-23	CFS-13-184-23	23 cm - 9"

0.3 mm 0.3 mm 0.7 mm 0.7 mm 8 mmØ

Tying platform 6.0 mm x 0.3mm, smooth
Fadenplatte 6,0 mm x 0,3mm, glatt
Plataforma 6.0 mm x 0.3mm, lisa
Plate-forme 6.0mm x 0.3mm, lisse
Piano per sutura 6.0 mm x 0.3mm, liscio

CFS-13-185-15	CFS-13-186-15	CFS-13-187-15	CFS-13-188-15	15 cm - 6"
CFS-13-185-18	CFS-13-186-18	CFS-13-187-18	CFS-13-188-18	18 cm - 7"
CFS-13-185-21	CFS-13-186-21	CFS-13-187-21	CFS-13-188-21	21 cm - 8 ¼"
CFS-13-185-23	CFS-13-186-23	CFS-13-187-23	CFS-13-188-23	23 cm - 9"

0.3 mm 0.3 mm 0.7 mm 0.7 mm 8 mmØ

Tying platform 6.0 mm x 0.7mm, smooth
Fadenplatte 6,0 mm x 0,7 mm, glatt
Plataforma 6.0 mm x 0.7mm, lisa
Plate-forme 6.0 mm x 0.7mm, lisse
Piano per sutura 6.0 mm x 0.7mm, liscio

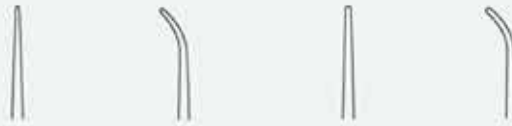

Lester

CFS-13-189-15	CFS-13-190-15	CFS-13-191-15	CFS-13-192-15	15 cm - 6"
CFS-13-189-18	CFS-13-190-18	CFS-13-191-18	CFS-13-192-18	18 cm - 7"
CFS-13-189-21	CFS-13-190-21	CFS-13-191-21	CFS-13-192-21	21 cm - 8 1/4"
CFS-13-189-23	CFS-13-190-23	CFS-13-191-23	CFS-13-192-23	23 cm - 9"

0.3 mm 0.3 mm 0.7 mm 0.7 mm 8 mmØ

diamond coated
diamantiert
diamantada
diamanté
diamantata



CFS-13-193-15	CFS-13-194-15	CFS-13-195-15	CFS-13-196-15	15 cm - 6"
CFS-13-193-18	CFS-13-194-18	CFS-13-195-18	CFS-13-196-18	18 cm - 7"
CFS-13-193-21	CFS-13-194-21	CFS-13-195-21	CFS-13-196-21	21 cm - 8 1/4"
CFS-13-193-23	CFS-13-194-23	CFS-13-195-23	CFS-13-196-23	23 cm - 9"

0.3 mm 0.3 mm 0.7 mm 0.7 mm 8 mmØ

1x2 1x2

Tying platform 6.0 mm x 0.3 mm, diamond coated
Fadenplatte 6.0 mm x 0.3 mm, diamantiert
Plataforma 6.0 mm x 0.3 mm, diamantada
Plate-forme 6.0 mm x 0.3 mm, diamanté
Piano per sutura 6.0 mm x 0.3 mm, diamantata



CFS-13-197-15	CFS-13-198-15	CFS-13-199-15	CFS-13-200-15	15 cm - 6"
CFS-13-197-18	CFS-13-198-18	CFS-13-199-18	CFS-13-200-18	18 cm - 7"
CFS-13-197-21	CFS-13-198-21	CFS-13-199-21	CFS-13-200-21	21 cm - 8 1/4"
CFS-13-197-23	CFS-13-198-23	CFS-13-199-23	CFS-13-200-23	23 cm - 9"

0.3 mm 0.3 mm 0.7 mm 0.7 mm 8 mmØ

1x2 1x2

Tying platform 6.0 mm x 0.7 mm, diamond coated
Fadenplatte 6.0 mm x 0.7 mm, diamantiert
Plataforma 6.0 mm x 0.7 mm, diamantada
Plate-forme 6.0 mm x 0.7 mm, diamanté
Piano per sutura 6.0 mm x 0.7 mm, diamantata





Jacobson

CFS-13-201-16

CFS-13-201-18

straight, sharp
gerade, spitz
recta, aguda
droit, pointue
retta, acuta



CFS-13-202-16

CFS-13-202-18

straight, blunt
gerade, stumpf
recta, roma
droit, mousse
retta, smussa



CFS-13-203-16

CFS-13-203-18

angled, sharp
abgewinkelt, spitz
acodada, aguda
angulaire, pointue
angolata, acuta



CFS-13-204-16

CFS-13-204-18

angled, blunt
abgewinkelt, stumpf
acodada, roma
angulaire, mousse
angolata, smussa

CFS-13-205-16

CFS-13-205-18

straight, sharp
gerade, spitz
recta, aguda
droit, pointue
retta, acuta

CFS-13-206-16

CFS-13-206-18

straight, blunt
gerade, stumpf
recta, roma
droit, mousse
retta, smussa

CFS-13-207-16

CFS-13-207-18

angled, sharp
abgewinkelt, spitz
acodada, aguda
angulaire, pointue
angolata, acuta

CFS-13-208-16

CFS-13-208-18

angled, blunt
abgewinkelt, stumpf
acodada, roma
angulaire, mousse
angolata, smussa

diamond coated
diamantiert
diamantada
diamanté
diamantata



Yasargil

CFS-13-209-22

CFS-13-209-22

22.5 cm - 8 3/4"
spoon form
löffelförmig
forma de cuchara
forme de cuillère
forma di cucchiaio



CFS-13-210-22

CFS-13-210-22

22.5 cm - 8 3/4"
plan toothed
flach gezahnt
dentada
dentelé
dentato



CFS-13-211-22

CFS-13-211-22

22.5 cm - 8 3/4"
curette form
kürettenförmig
forma de cureta
forme de curette
forma di curetta

3.0 mm

5.0 mm



Yasagil

CFS-13-212-20

CFS-13-212-22

straight, sharp
gerade, spitz
recta, aguda
droit, pointue
retta, acuta

diamond coated
diamantiert
diamantado
diamanté
diamantato



CFS-13-213-20

CFS-13-213-22

straight, blunt
gerade, stumpf
recta, roma
droit, mousse
retta, smussa

CFS-13-214-20

CFS-13-214-22

angled, sharp
abgewinkelt, spitz
acodada, aguda
angulaire, pointue
angolata, acuta

CFS-13-215-20

CFS-13-215-22

20 cm - 8"

22.5 cm - 8 ¾"

angled, blunt
abgewinkelt, stumpf
acodada, roma
angulaire, mousse
angolata, smussa

CFS-13-216-22

straight, sharp
gerade, spitz
recta, aguda
droit, pointue
retta, acuta

Titanium

CFS-13-217-22

22.5 cm - 8 ¾"

straight, blunt
gerade, stumpf
recta, roma
droit, mousse
retta, smussa

CFS-13-218-20

CFS-13-218-22

angled, sharp
abgewinkelt, spitz
acodada, aguda
angulaire, pointue
angolata, acuta

CFS-13-219-20

CFS-13-219-22

20 cm - 8"

22.5 cm - 8 ¾"

angled, blunt
abgewinkelt, stumpf
acodada, roma
angulaire, mousse
angolata, smussa





Wolf
9 mmØ

CFS-13-220-21
CFS-13-220-23

straight, sharp
gerade, spitz
recta, aguda
droit, pointue
retta, acuta



9 mmØ

CFS-13-221-21
CFS-13-221-23

straight, blunt
gerade, stumpf
recta, roma
droit, mousse
retta, smussa



9 mmØ

CFS-13-222-21
CFS-13-222-23

angled, sharp
abgewinkelt, spitz
acodada, aguda
angulaire, pointue
angolata, acuta



9 mmØ

CFS-13-223-21 21 cm - 8 1/4"
CFS-13-223-23 23 cm - 9"

angled, blunt
abgewinkelt, stumpf
acodada, roma
angulaire, mousse
angolata, smussa

9 mmØ

CFS-13-224-21
CFS-13-224-23

straight, sharp
gerade, spitz
recta, aguda
droit, pointue
retta, acuta

9 mmØ

CFS-13-225-21
CFS-13-225-23

straight, blunt
gerade, stumpf
recta, roma
droit, mousse
retta, smussa

9 mmØ

CFS-13-226-21
CFS-13-226-23

angled, sharp
abgewinkelt, spitz
acodada, aguda
angulaire, pointue
angolata, acuta

9 mmØ







CFS-13-227-21 21 cm - 8 1/4"
CFS-13-227-23 23 cm - 9"

angled, blunt
abgewinkelt, stumpf
acodada, roma
angulaire, mousse
angolata, smussa

diamond coated
diamantiert
diamantado
diamanté
diamantato



Herman

						
CFS-13-228-15	CFS-13-229-15	CFS-13-230-15	CFS-13-231-15	CFS-13-232-15	CFS-13-233-15	15 cm - 6"
CFS-13-228-18	CFS-13-229-18	CFS-13-230-18	CFS-13-231-18	CFS-13-232-18	CFS-13-233-18	18 cm - 7"
CFS-13-228-21	CFS-13-229-21	CFS-13-230-21	CFS-13-231-21	CFS-13-232-21	CFS-13-233-21	21 cm - 8 1/4"
CFS-13-228-23	CFS-13-229-23	CFS-13-230-23	CFS-13-231-23	CFS-13-232-23	CFS-13-233-23	23 cm - 9"
1.0 x 0.5 mm smooth glatt lisa lisse liscia	1.0 x 0.5 mm slightly serrated fein gerieft lig. estriada légèrement strié fina zigrinata	2.0 x 1.0 mm smooth glatt lisa lisse liscia	2.0 x 1.0 mm slightly serrated fein gerieft lig. estriada légèrement strié fina zigrinata	1.0 x 0.5 mm diamond coated diamantiert diamantada diamanté diamantata	2.0 x 1.0 mm 9 mmØ diamond coated diamantiert diamantada diamanté diamantata	

CFS-13-234-15	CFS-13-235-15	CFS-13-236-15	CFS-13-237-15	CFS-13-238-15	CFS-13-239-15	15 cm - 6"
CFS-13-234-18	CFS-13-235-18	CFS-13-236-18	CFS-13-237-18	CFS-13-238-18	CFS-13-239-18	18 cm - 7"
CFS-13-234-21	CFS-13-235-21	CFS-13-236-21	CFS-13-237-21	CFS-13-238-21	CFS-13-239-21	21 cm - 8 1/4"
CFS-13-234-23	CFS-13-235-23	CFS-13-236-23	CFS-13-237-23	CFS-13-238-23	CFS-13-239-23	23 cm - 9"
1.0 x 0.5 mm smooth glatt lisa lisse liscia	1.0 x 0.5 mm slightly serrated fein gerieft lig. estriada légèrement strié fina zigrinata	2.0 x 1.0 mm smooth glatt lisa lisse liscia	2.0 x 1.0 mm slightly serrated fein gerieft lig. estriada légèrement strié fina zigrinata	1.0 x 0.5 mm diamond coated diamantiert diamantada diamanté diamantata	2.0 x 1.0 mm 9 mmØ diamond coated diamantiert diamantada diamanté diamantata	

Titanium





Herman

CFS-13-240-21

CFS-13-240-23

1.0 mm x 0.5 mm
smooth
glatt
liso
lisse
liscia



CFS-13-241-21

CFS-13-241-23

1.0 mm x 0.5 mm
serrated
gerieft
estriada
strié
zigrinata



CFS-13-242-21

CFS-13-242-23

2.0 mm x 1.0 mm
smooth
glatt
liso
lisse
liscia



CFS-13-243-21

CFS-13-243-23

2.0 mm x 1.0 mm 9 mmØ
serrated
gerieft
estriada
strié
zigrinata

21 cm - 8 1/4"

23 cm - 9"



CFS-13-244-21

CFS-13-244-23

1.0 mm x 0.5 mm
diamond coated
diamantiert
diamantada
diamanté
diamantata



CFS-13-245-21

CFS-13-245-23

2.0 mm x 1.0 mm 9 mmØ

21 cm - 8 1/4"

23 cm - 9"



Stenberg

- CFS-13-246-15
- CFS-13-246-18
- CFS-13-246-21
- CFS-13-246-23

x = 1.2 mm
 straight
 gerade
 recta
 droit
 retta



- CFS-13-247-15
- CFS-13-247-18
- CFS-13-247-21
- CFS-13-247-23

x = 2.0 mm
 straight
 gerade
 recta
 droit
 retta

- CFS-13-248-15
- CFS-13-248-18
- CFS-13-248-21
- CFS-13-248-23

x = 1.2 mm
 angled
 abgewinkelt
 acodada
 angulaire
 angolata

- CFS-13-249-15
- CFS-13-249-18
- CFS-13-249-21
- CFS-13-249-23

x = 2.0 mm
 angled
 abgewinkelt
 acodada
 angulaire
 angolata

- 15 cm - 6"
- 18 cm - 7"
- 21 cm - 8 1/4"
- 23 cm - 9"





Castroviejo

CFS-13-250-14

CFS-13-251-14

CFS-13-252-14

CFS-13-253-14

14 cm - 5 1/2"

x = 11.0 mm x 0.75 mm

straight
gerade
recta
droit
retto

curved
gebogen
curva
courbe
curvo

straight, diamond coated
gerade, diamantiert
recta, diamantada
droit, diamanté
retto, diamantato

curved, diamond coated
gebogen, diamantiert
curva, diamantada
courbe, diamanté
curvo, diamantato

without ratchet, fine jaws
ohne Sperre, feines Maul
sin cremallera, boca fina
sans crémaillère, mors fine
senza cremagliera, morso fino

CFS-13-254-14

CFS-13-255-14

CFS-13-256-14

CFS-13-257-14

14 cm - 5 1/2"

x = 11.0 mm x 0.75 mm

straight
gerade
recta
droit
retto

curved
gebogen
curva
courbe
curvo

straight, diamond coated
gerade, diamantiert
recta, diamantada
droit, diamanté
retto, diamantato

curved, diamond coated
gebogen, diamantiert
curva, diamantada
courbe, diamanté
curvo, diamantato

with ratchet, fine jaws
mit Sperre, feines Maul
con cremallera, boca fina
avec crémaillère, mors fine
con cremagliera, morso fino



Jacobson

CFS-13-258-18

x = 1 mm
straight
gerade
recta
droit
retto

CFS-13-259-18

x = 1 mm
curved
gebogen
curva
courbe
curvo

CFS-13-260-18

x = 1 mm
straight, diamond coated
gerade, diamantiert
recta, diamantada
droit, diamanté
retto, diamantato

CFS-13-261-18 18 cm - 7"

x = 1 mm
curved, diamond coated
gebogen, diamantiert
curva, diamantada
courbe, diamanté
curvo, diamantato

without ratchet
ohne Sperre
sin cremallera
sans crémaillère
senza cremagliera

CFS-13-262-18

x = 1 mm
straight
gerade
recta
droit
retto

CFS-13-263-18

x = 1 mm
curved
gebogen
curva
courbe
curvo

CFS-13-264-18

x = 1 mm
straight, diamond coated
gerade, diamantiert
recta, diamantada
droit, diamanté
retto, diamantato

CFS-13-265-18 18 cm - 7"

x = 1 mm
curved, diamond coated
gebogen, diamantiert
curva, diamantada
courbe, diamanté
curvo, diamantato

with ratchet
mit Sperre
con cremallera
avec crémaillère
con cremagliera



CFS-13-266-18

x = 1 mm
straight, smooth
gerade, glatt
recta, liso
droit, lisse
retto, liscio

CFS-13-267-18

x = 1 mm
curved, smooth
gebogen, glatt
curva, lisa
courbe, lisse
curvo, liscio

CFS-13-268-18

x = 1 mm
straight, serrated
gerade, gerieft
recta, estriada
droit, strié
retto, zigrinato

CFS-13-269-18 18 cm - 7"

x = 1 mm 1 mm
curved, serrated
gebogen, gerieft
curva, estriada
courbe, strié
curvo, zigrinato

without ratchet
ohne Sperre
sin cremallera
sans crémaillère
senza cremagliera

CFS-13-270-18

x = 1 mm
straight, smooth
gerade, glatt
recta, liso
droit, lisse
retto, liscio

CFS-13-271-18

x = 1 mm
curved, smooth
gebogen, glatt
curva, lisa
courbe, lisse
curvo, liscio

CFS-13-272-18

x = 1 mm
straight, serrated
gerade, gerieft
recta, estriada
droit, strié
retto, zigrinato

CFS-13-273-18 18 cm - 7"

x = 1 mm 1 mm
curved, serrated
gebogen, gerieft
curva, estriada
courbe, strié
curvo, zigrinato

with ratchet
mit Sperre
con cremallera
avec crémaillère
con cremagliera





Yasargil

CFS-13-274-18	CFS-13-275-18	CFS-13-276-18	CFS-13-277-18	18 cm - 7"
CFS-13-274-20	CFS-13-275-20	CFS-13-276-20	CFS-13-277-20	20 cm - 8"
straight	curved	straight, diamond coated	curved, diamond coated	
gerade	gebogen	gerade, diamantiert	gebogen, diamantiert	
recta	curva	recta, diamantada	curva, diamantada	
droit	courbe	droit, diamanté	courbe, diamanté	
retto	curvo	retto, diamantato	curvo, diamantato	

without ratchet
ohne Sperre
sin cremallera
sans crémaillère
senza cremagliera

CFS-13-278-18	CFS-13-279-18	CFS-13-280-18	CFS-13-281-18	18 cm - 7"
CFS-13-278-20	CFS-13-279-20	CFS-13-280-20	CFS-13-281-20	20 cm - 8"
straight	curved	straight, diamond coated	curved, diamond coated	
gerade	gebogen	gerade, diamantiert	gebogen, diamantiert	
recta	curva	recta, diamantada	curva, diamantada	
droit	courbe	droit, diamanté	courbe, diamanté	
retto	curvo	retto, diamantato	curvo, diamantato	

with ratchet
mit Sperre
con cremallera
avec crémaillère
con cremagliera



Jacobson

CFS-13-282-21

x = 1 mm
straight
gerade
recta
droit
retto

CFS-13-283-21

x = 1 mm
curved
gebogen
curva
courbe
curvo

CFS-13-284-21

x = 1 mm
straight, diamond coated
gerade, diamantiert
recta, diamantada
droit, diamanté
retto, diamantato

CFS-13-285-21 21 cm - 8 ¼"

x = 1 mm
curved, diamond coated
gebogen, diamantiert
curva, diamantada
courbe, diamanté
curvo, diamantato

without ratchet
ohne Sperre
sin cremallera
sans crémaillère
senza cremagliera

CFS-13-286-21

x = 1 mm
straight
gerade
recta
droit
retto

CFS-13-287-21

x = 1 mm
curved
gebogen
curva
courbe
curvo

CFS-13-288-21

x = 1 mm
straight, diamond coated
gerade, diamantiert
recta, diamantada
droit, diamanté
retto, diamantato

CFS-13-289-21 21 cm - 8 ¼"

x = 1 mm
curved, diamond coated
gebogen, diamantiert
curva, diamantada
courbe, diamanté
curvo, diamantato

with ratchet
mit Sperre
con cremallera
avec crémaillère
con cremagliera



CFS-13-290-21

x = 1 mm
straight, smooth
gerade, glatt
recta, liso
droit, lisse
retto, liscio



CFS-13-291-21

x = 1 mm
curved, smooth
gebogen, glatt
curva, lisa
courbe, lisse
curvo, liscio



CFS-13-292-21

x = 1 mm
straight, serrated
gerade, gerieft
recta, estriada
droit, strié
retto, zigrinato



CFS-13-293-21 21 cm - 8 ¼"

x = 1 mm
curved, serrated
gebogen, gerieft
curva, estriada
courbe, strié
curvo, zigrinato

without ratchet
ohne Sperre
sin cremallera
sans crémaillère
senza cremagliera

CFS-13-294-21

x = 1 mm
straight, smooth
gerade, glatt
recta, liso
droit, lisse
retto, liscio

CFS-13-295-21

x = 1 mm
curved, smooth
gebogen, glatt
curva, lisa
courbe, lisse
curvo, liscio

CFS-13-296-21

x = 1 mm
straight, serrated
gerade, gerieft
recta, estriada
droit, strié
retto, zigrinato

CFS-13-297-21 21 cm - 8 ¼"

x = 1 mm
curved, serrated
gebogen, gerieft
curva, estriada
courbe, strié
curvo, zigrinato

with ratchet
mit Sperre
con cremallera
avec crémaillère
con cremagliera



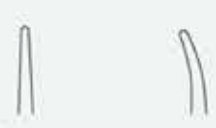

Hubson

CFS-13-299-01	CFS-13-300-01	11 cm - 4 1/4"	8 mmØ
CFS-13-299-02	CFS-13-300-02	12.5 cm - 5"	7 mmØ
CFS-13-299-03	CFS-13-300-03	13 cm - 5"	8 mmØ
CFS-13-299-04	CFS-13-300-04	13 cm - 5"	10 mmØ
CFS-13-299-05	CFS-13-300-05	15 cm - 6"	8 mmØ
CFS-13-299-06	CFS-13-300-06	18 cm - 7"	8 mmØ
CFS-13-299-07	CFS-13-300-07	18 cm - 7"	10 mmØ

straight gerade recta droit retto	curved gebogen curva courbe curvo
---	---

without ratchet
 ohne Sperre
 sin cremallera
 sans crémaillère
 senza cremagliera

CFS-13-301-01	CFS-13-302-01	11 cm - 4 1/4"	8 mmØ
CFS-13-301-02	CFS-13-302-02	12.5 cm - 5"	7 mmØ
CFS-13-301-03	CFS-13-302-03	13 cm - 5"	8 mmØ
CFS-13-301-04	CFS-13-302-04	13 cm - 5"	10 mmØ
CFS-13-301-05	CFS-13-302-05	15 cm - 6"	8 mmØ
CFS-13-301-06	CFS-13-302-06	18 cm - 7"	8 mmØ
CFS-13-301-07	CFS-13-302-07	18 cm - 7"	10 mmØ

straight gerade recta droit retto	curved gebogen curva courbe curvo
---	---

with ratchet
 mit Sperre
 con cremallera
 avec crémaillère
 con cremagliera



Barraquer

CFS-13-303-14

straight
gerade
recta
droit
retto

CFS-13-304-14

curved
gebogen
curva
courbe
curvo

CFS-13-305-14

straight, diamond coated
gerade, diamantiert
recta, diamantada
droit, diamanté
retto, diamantato

CFS-13-306-14

curved, diamond coated
gebogen, diamantiert
curva, diamantada
courbe, diamanté
curvo, diamantato

14 cm - 5 1/2"

8 mmØ

without ratchet, extra delicate jaws
ohne Sperre, sehr feines Maul
sin cremallera, boca muy fina
sans crémaillère, mors très fine
senza cremagliera, morso molto fino

CFS-13-307-14

straight
gerade
recta
droit
retto

CFS-13-308-14

curved
gebogen
curva
courbe
curvo

CFS-13-309-14

straight, diamond coated
gerade, diamantiert
recta, diamantada
droit, diamanté
retto, diamantato

CFS-13-310-14

curved, diamond coated
gebogen, diamantiert
curva, diamantada
courbe, diamanté
curvo, diamantato

14 cm - 5 1/2"

8 mmØ

with ratchet, extra delicate jaws
mit Sperre, sehr feines Maul
con cremallera, boca muy fina
avec crémaillère, mors très fine
con cremagliera, morso molto fino



Dylex Hegar

CFS-13-311-15

15 cm - 6"
9 mm Ø

without ratchet, curved
ohne Sperre, gebogen
sin cremallera, curvo
sans crémaillère, courbe
senza cremagliera, curvo



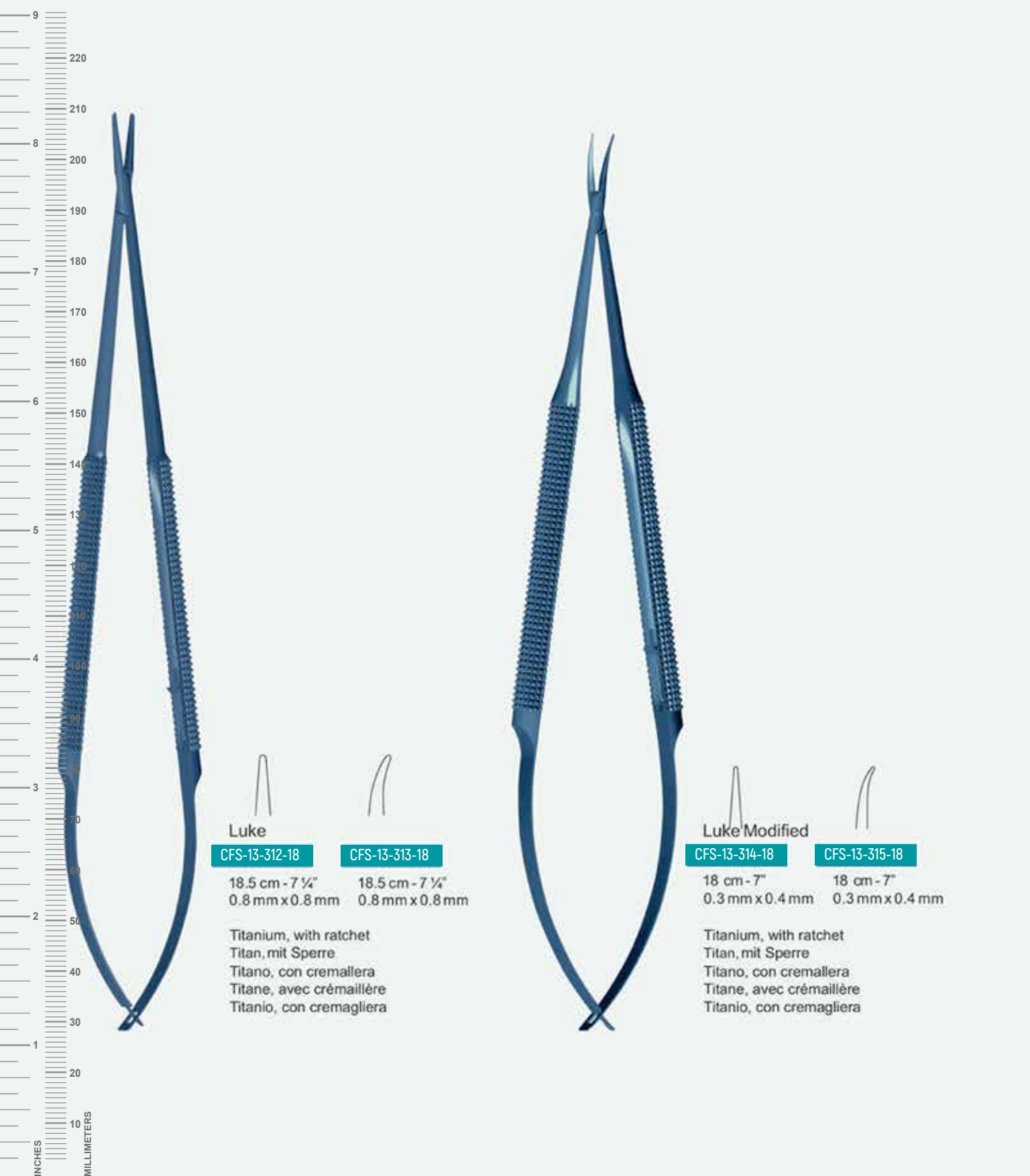

Luke
CFS-13-312-18 **CFS-13-313-18**
 18.5 cm - 7 1/4" 18.5 cm - 7 1/4"
 0.8 mm x 0.8 mm 0.8 mm x 0.8 mm

Titanium, with ratchet
 Titan, mit Sperre
 Titano, con cremallera
 Titane, avec crémaillère
 Titanio, con cremagliera

Luke Modified
CFS-13-314-18 **CFS-13-315-18**
 18 cm - 7" 18 cm - 7"
 0.3 mm x 0.4 mm 0.3 mm x 0.4 mm

Titanium, with ratchet
 Titan, mit Sperre
 Titano, con cremallera
 Titane, avec crémaillère
 Titanio, con cremagliera

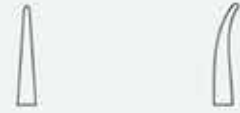

York

CFS-13-320-20

20 cm - 8"

0.5 mm x 0.8 mm

CFS-13-321-20

20 cm - 8"

0.5 mm x 0.8 mm

Titanium, with ratchet
 Titan, mit Sperre
 Titano, con cremallera
 Titane, avec crémaillère
 Titanio, con cremagliera



Zeff

CFS-13-316-20

0.4 x 0.6 mm

CFS-13-317-20

0.4 x 0.6 mm

CFS-13-318-20

0.6 x 0.6 mm

CFS-13-319-20

0.6 x 0.6 mm

20 cm - 8"

Titanium, with ratchet
 Titan, mit Sperre
 Titano, con cremallera
 Titane, avec crémaillère
 Titanio, con cremagliera





Carlson

CFS-13-322-01



CFS-13-323-01 22.5 cm - 8 3/4"

CFS-13-322-02

without ratchet
 ohne Sperre
 sin cremallera
 sans crémaillère
 senza cremagliera

Titanium
 Titan
 Titano
 Titane
 Titanio

CFS-13-323-02 22.5 cm - 8 3/4"

CFS-13-324-22

with ratchet
 mit Sperre
 con cremallera
 avec crémaillère
 con cremagliera

Titanium
 Titan
 Titano
 Titane
 Titanio

CFS-13-325-22 22.5 cm - 8 3/4"



Yasargil

CFS-13-326-20	CFS-13-327-20
CFS-13-326-22	CFS-13-327-22
CFS-13-326-24	CFS-13-327-24

x = 0.4 mm
straight
gerade
recta
droit
retto



CFS-13-327-20	CFS-13-327-22
CFS-13-327-22	CFS-13-327-24

x = 0.4 mm
curved
gebogen
curva
courbe
curvo



CFS-13-328-20	CFS-13-328-22
CFS-13-328-22	CFS-13-328-24

x = 0.9 mm
straight
gerade
recta
droit
retto



CFS-13-329-20	20 cm - 8"
CFS-13-329-22	22.5 cm - 8 ¾"
CFS-13-329-24	24 cm - 9 ½"

x = 0.9 mm
curved
gebogen
curva
courbe
curvo

without ratchet
ohne Sperre
sin cremallera
sans crémaillère
senza cremagliera

CFS-13-330-20	CFS-13-331-20
CFS-13-330-22	CFS-13-331-22
CFS-13-330-24	CFS-13-331-24

x = 0.4 mm
straight
gerade
recta
droit
retto

CFS-13-331-20	CFS-13-331-22
CFS-13-331-22	CFS-13-331-24

x = 0.4 mm
curved
gebogen
curva
courbe
curvo

CFS-13-332-20	CFS-13-332-22
CFS-13-332-22	CFS-13-332-24

x = 0.9 mm
straight
gerade
recta
droit
retto

CFS-13-333-20	20 cm - 8"
CFS-13-333-22	22.5 cm - 8 ¾"
CFS-13-333-24	24 cm - 9 ½"

x = 0.9 mm
curved
gebogen
curva
courbe
curvo

without ratchet, diamond coated
ohne Sperre, diamantiert
sin cremallera, diamantada
sans crémaillère, diamanté
senza cremagliera, diamantato



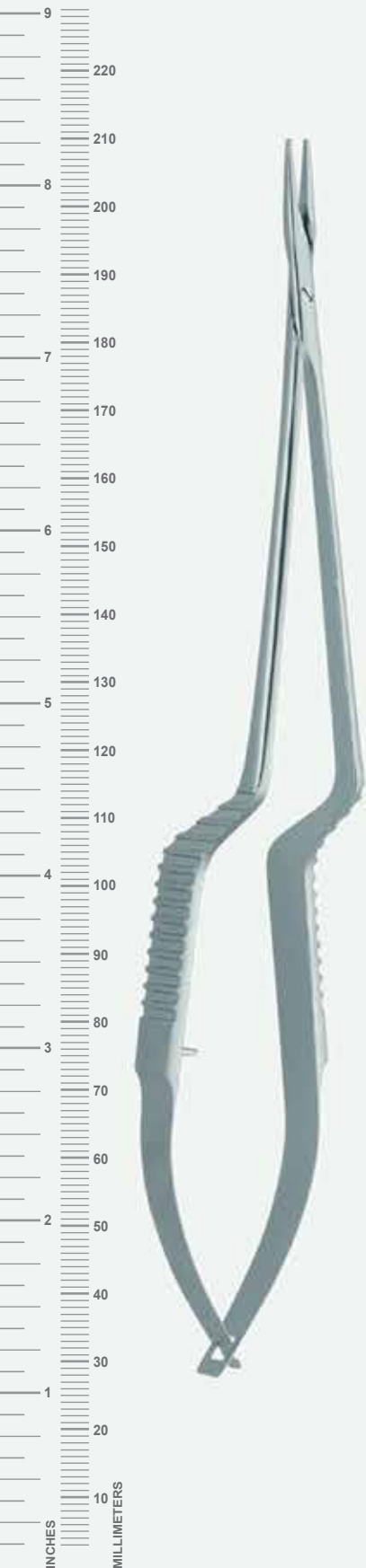

Jacobson



CFS-13-334-18

CFS-13-335-18

CFS-13-336-18

CFS-13-337-18

18 cm - 7"

straight
gerade
recta
droit
retto

curved
gebogen
curva
courbe
curvo

straight, diamond coated
gerade, diamantiert
recta, diamantada
droit, diamanté
retto, diamantato

curved, diamond coated
gebogen, diamantiert
curva, diamantada
courbe, diamanté
curvo, diamantato

without ratchet
ohne Sperre
sin cremallera
sans crémaillère
senza cremagliera

CFS-13-338-18

CFS-13-339-18

CFS-13-340-18

CFS-13-341-18

18 cm - 7"

straight
gerade
recta
droit
retto

curved
gebogen
curva
courbe
curvo

straight, diamond coated
gerade, diamantiert
recta, diamantada
droit, diamanté
retto, diamantato

curved, diamond coated
gebogen, diamantiert
curva, diamantada
courbe, diamanté
curvo, diamantato

with ratchet
mit Sperre
con cremallera
avec crémaillère
con cremagliera



Range

CFS-13-342-23	CFS-13-343-23	CFS-13-344-23	CFS-13-345-23	23 cm - 9"	9 mmØ
----------------------	----------------------	----------------------	----------------------	------------	-------

x = 1.0 mm straight gerade recta droit retto	x = 1.0 mm curved gebogen curva courbe curvo	x = 1.0 mm straight, diamond coated gerade, diamantiert recta, diamantada droit, diamanté retto, diamantato	x = 1.0 mm curved, diamond coated gebogen, diamantiert curva, diamantada courbe, diamanté curvo, diamantato
---	---	--	--

without ratchet
ohne Sperre
sin cremallera
sans crémaillère
senza cremagliera

CFS-13-346-23	CFS-13-347-23	CFS-13-348-23	CFS-13-349-23	23 cm - 9"	9 mmØ
----------------------	----------------------	----------------------	----------------------	------------	-------

x = 1.0 mm straight gerade recta droit retto	x = 1.0 mm curved gebogen curva courbe curvo	x = 1.0 mm straight, diamond coated gerade, diamantiert recta, diamantada droit, diamanté retto, diamantato	x = 1.0 mm curved, diamond coated gebogen, diamantiert curva, diamantada courbe, diamanté curvo, diamantato
---	---	--	--

with ratchet
mit Sperre
con cremallera
avec crémaillère
con cremagliera



CFS-13-350-23	CFS-13-351-23	CFS-13-352-23	CFS-13-353-23	23 cm - 9"	9 mmØ
----------------------	----------------------	----------------------	----------------------	------------	-------

straight, smooth gerade, glatt recta, liso droit, lisse retto, liscio	curved, smooth gebogen, glatt curva, lisa courbe, lisse curvo, liscio	straight, serrated gerade, gerieft recta, estriada droit, strié retto, zigrinato	curved, serrated gebogen, gerieft curva, estriada courbe, strié curvo, zigrinato
---	---	--	--

without ratchet
ohne Sperre
sin cremallera
sans crémaillère
senza cremagliera

CFS-13-354-23	CFS-13-355-23	CFS-13-356-23	CFS-13-357-23	23 cm - 9"	9 mmØ
----------------------	----------------------	----------------------	----------------------	------------	-------

straight, smooth gerade, glatt recta, liso droit, lisse retto, liscio	curved, smooth gebogen, glatt curva, lisa courbe, lisse curvo, liscio	straight, serrated gerade, gerieft recta, estriada droit, strié retto, zigrinato	curved, serrated gebogen, gerieft curva, estriada courbe, strié curvo, zigrinato
---	---	--	--

with ratchet
mit Sperre
con cremallera
avec crémaillère
con cremagliera

