

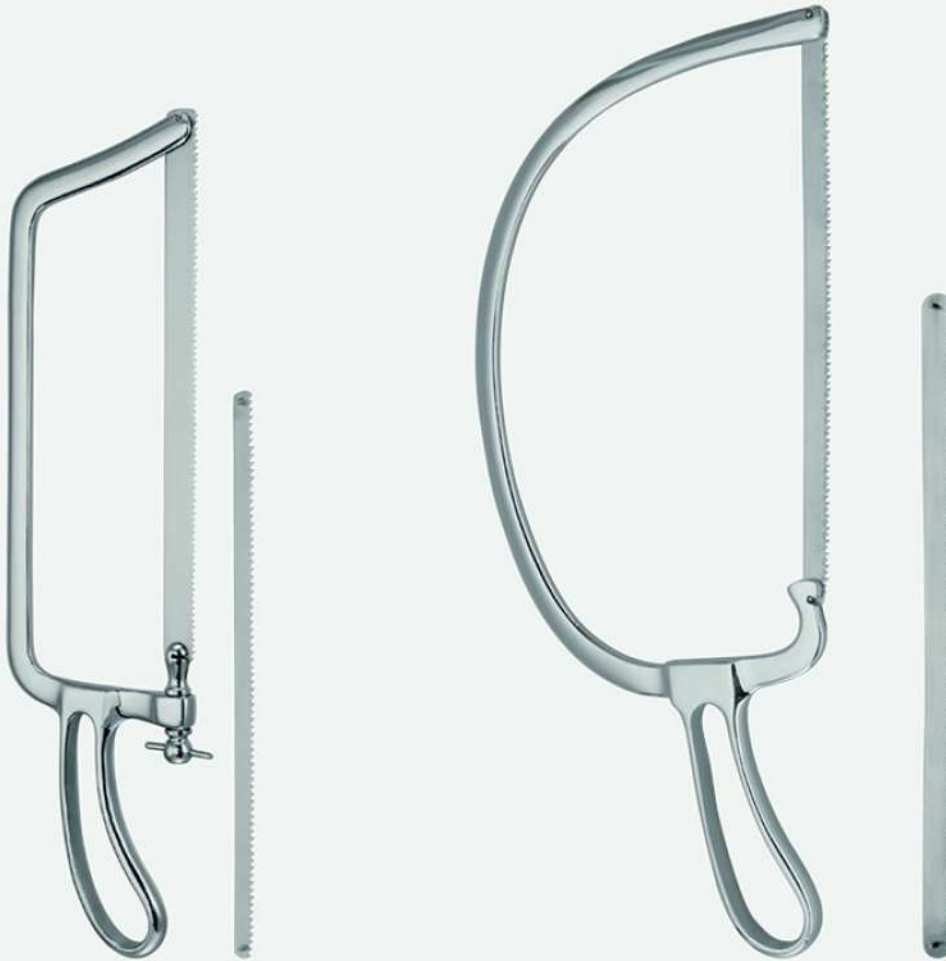

12

Bone Surgery
Knochenchirurgie
Cirugia osea
Chirurgie Osseuse
Chirurgia ossea

Biopsy Needles



Charriere

CFS-12-500-35	CFS-12-501-12	1.2 cm
35 cm - 13 3/4"	CFS-12-501-15	1.5 cm

Spare saw blades
 Ersatzsägeblätter
 Hojas de cambio
 Lames de rechange
 Lame di ricambio

HelferichBier

CFS-12-502-35	CFS-12-503-03	3 mm
39 cm - 15 1/2"	CFS-12-503-05	5 mm
	CFS-12-503-07	7 mm

Spare saw blades
 Ersatzsägeblätter
 Hojas de cambio
 Lames de rechange
 Lame di ricambio





Satterlee
CFS-12-504-31
31 cm - 12 1/4"



Langenbeck
CFS-12-505-23
23 cm - 9"



Charriere
CFS-12-506-27 27 cm - 10 3/4"
CFS-12-506-30 30 cm - 12"
CFS-12-506-34 34 cm - 13 1/2"

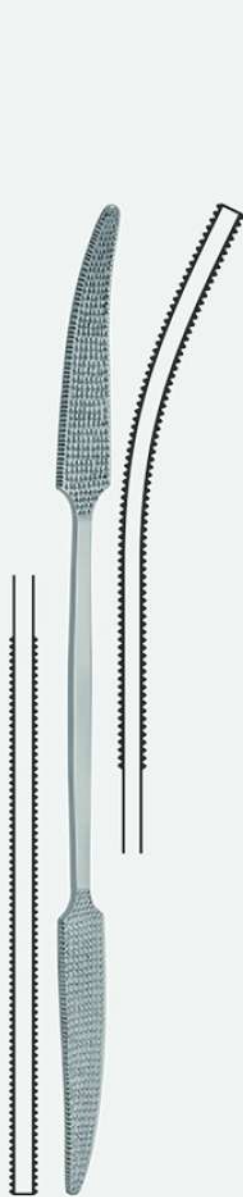

Putti
 Fig. 1
CFS-12-507-27
 27 cm - 10 3/4"

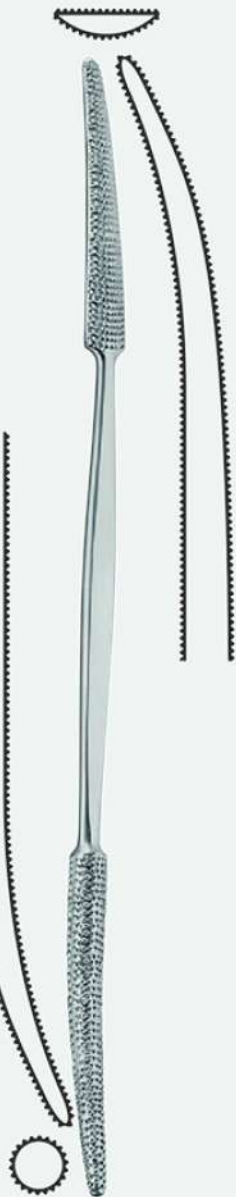

Fig. 2
CFS-12-508-30
 30 cm - 12"



Rasp
 Fig. 1
CFS-12-509-28
 28 cm - 11"

semi circular
 halbrund
 semi-redonda
 semi-ronde
 semi-rotonda



Fig. 2
CFS-12-510-24
 24.5 cm - 9 3/4"
 x = 13 mm

semi circular
 halbrund
 semi-redonda
 semi-ronde
 semi-rotonda



Fig. 3
CFS-12-511-22
 22 cm - 8 3/4"
 x = 20 mm

flat
 flach
 plana
 plate
 piatta



Doyen
CFS-12-512-12 2.5 cmØ – 120 g
CFS-12-512-18 3.0 cmØ – 180 g
CFS-12-512-26 3.5 cmØ – 260 g
 19.5 cm - 7 ¾"



Collin
CFS-12-513-20
 20 cm - 8"
 30 mmØ – 220 g



Hajek
CFS-12-514-21
 21.5 cm - 8 ½"
 27 mmØ – 140 g



Kirk
CFS-12-515-19
 19. cm - 7 ½"
 38 mmØ – 750 g



Partsch
CFS-12-516-18
 18 cm - 7"
 22 mmØ – 200 g



Lucae
CFS-12-517-19 19 mmØ – 230 g
CFS-12-517-25 25 mmØ – 260 g
 19 cm - 7 ½"



Williger
CFS-12-518-16
16.5 cm - 6 1/2"
20 mm Ø - 140 g



Mead
CFS-12-519-17
17 cm - 6 3/4"
26 mmØ - 320 g
Steel solid, with plastic faces
Stahl massiv, mit Kunststoffbacken
Acero solido, con placas en plastica
Acier solid, avec plaques en plastique
Acciaio massiccio, con punte di plastica



Bergmann
CFS-12-523-24
24.5 cm - 9 3/4"
45 mmØ - 300 g



Ombredanne
CFS-12-521-24
24 cm - 9 1/2"
40 mmØ - 550 g



Heath
CFS-12-522-18 40 mmØ - 700 g 18 cm - 7"
CFS-12-522-20 45 mmØ - 1000 g 20 cm - 8"

Copper filled head
Kupferfüllung
Llenado de cobre
Rempli de cuivre
Riempito di rame



Mead Modified

CFS-12-524-19

19 cm - 7 ½"

250 mmØ - 205 g

Solid steel, with plastic faces

Massiver Stahl, mit Kunststoffbacken

Acero solido, con placas en plastica

Acier solid, avec plaques en plastique

Accaio massiccio, con punte di plastica

CFS-12-525-19

Spare faces, 1 pair

Ersatzbacken, 1 Paar

Placas de cambio, 1 par

Plaques de rechange, 1 paire

Punte di ricambio, 1 paio



Cottle

CFS-12-526-18

18.5 cm - 7 ¼"

30 mmØ - 240 g

1 side flat/1 side convex

1 Seite flach / 1 Seite convex

1 lado plano / 1 lado convexo

1 coté plat / 1 coté convex

1 lato piatto / 1 lato convesso



Williger

CFS-12-527-28 28 mmØ - 340 g

CFS-12-527-30 30 mm Ø - 400 g

24 cm - 9 ½"

lead filled

bleigefüllt

llenado con plomo

rempli de plomb

riempito di piombo

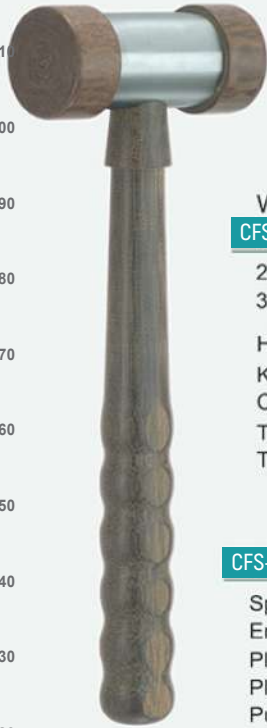

Waze
CFS-12-528-22
22.5 cm - 8 ¾"
37 mmØ - 370 g

Head solid steel, with Ferrozell faces
Kopf massiver Stahl, mit Ferrozellbacken
Cabeza acero solido, con placas en Ferrozell
Tête acier solid, avec plaques en Ferrozell
Testa acciaio massiccio, con punte di Ferrozell

CFS-12-529-22
Spare faces, 1 pair
Ersatzbacken, 1 Paar
Placas de cambio, 1 par
Plaques de rechange, 1 paire
Punte di ricambio, 1 paio



Jonathan
CFS-12-530-24
24 cm - 9 ½"
30 mmØ - 480 g

Head solid steel, Ferrozell handle
Kopf massiver Stahl, mit Ferrozellstiel
Cabeza acero solido, con mango en Ferrozell
Tête acier solid, manche en matière Ferrozell
Testa acciaio massiccio, con manico di Ferrozell



Jonathan Modified
CFS-12-531-26
42 mmØ - 250 g

Ferrozell, without lead
Ferrozell, ohne Blei
Ferrozell, sin plomo
Ferrozell, sans plomb
Ferrozell, senza piombo

CFS-12-532-26 26 cm - 10 ¼"
42 mmØ - 400 g

Plastic, lead filled
Kunststoff, bleigefüllt
Plastico, llenado con plomo
Matière plastique, rempli de plomb
Plastica, riempito di piombo



Darson
CFS-12-533-26 26.5 cm - 10 ½"
30 mmØ - 450 g

CFS-12-534-26 26.5 cm - 10 ½"
50 mmØ - 900 g



CFS-12-535-18

18.5 cm - 7 1/4"
Handle Only



CFS-12-540-09

9 cm - 3 1/2"
Key
Spannschlüssel
Llave
Clé
Chiave

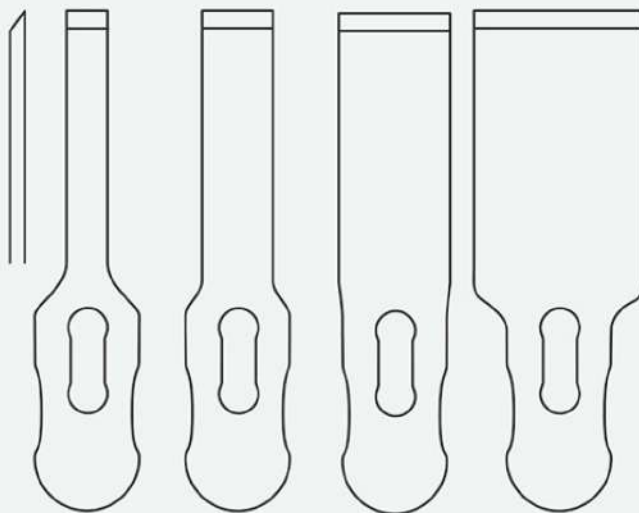

Arrow

CFS-12-536-08 **CFS-12-537-08** **CFS-12-538-08** **CFS-12-539-08** 8.5 cm - 3 1/4"
5 mm 10 mm 16 mm 25 mm

Chisel blades, interchangeable
Meißelklingen, auswechselbar
Hojas de cincel, intercambiables
Lames ciseaux-burin, interchangeables
Lame, intercambiabili

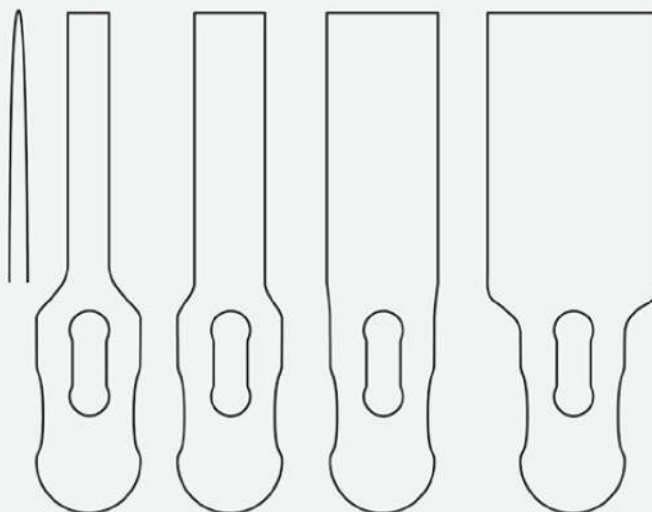

CFS-12-541-08 **CFS-12-542-08** **CFS-12-543-08** **CFS-12-544-08** 8.5 cm - 3 1/4"
5 mm 10 mm 16 mm 25 mm

Osteotome blades, interchangeable
Osteotomklingen, auswechselbar
Hojas de osteótomo, intercambiables
Lames d'osteotomos interchangeables
Lame per osteotomia, intercambiabili

CFS-12-535-00	Complete set consisting:
CFS-12-535-18	Handle
CFS-12-540-09	Key
	Chisel blades 12-536-08 to 12-539-08
	Osteotome blades 12-541-08 to 12-544-08

Bone Chisels and Gouges

Knochenmeißel

Cinceles, gubias

Ciseaux-burins, gouges

Bone scalpelli e Sgorbie



Mourd

CFS-12-545-08	CFS-12-546-08	CFS-12-547-08	8 mm
CFS-12-545-10	CFS-12-546-10	CFS-12-547-10	10 mm
CFS-12-545-12	CFS-12-546-12	CFS-12-547-12	12 mm
CFS-12-545-14	CFS-12-546-14	CFS-12-547-14	14 mm
CFS-12-545-16	CFS-12-546-16	CFS-12-547-16	16 mm

13.5 cm - 5 1/4" 13.5 cm - 5 1/4" 13.5 cm - 5 1/4"

Lucas

CFS-12-548-03	CFS-12-548-07	3 mm
CFS-12-548-04	CFS-12-548-08	4 mm
CFS-12-5478-05	CFS-12-548-09	5 mm
CFS-12-548-06	CFS-12-548-10	6 mm

16 cm - 6 1/4"	16 cm - 6 1/4"
Chisel	Gouge
Flachmeißel	Hohlmeißel
Cinzel	Gubia
Ciseau burin	Gouge
Scalpello	Sgorbie

Partsch

CFS-12-549-02	CFS-12-550-02	CFS-12-551-02	2 mm
CFS-12-549-03	CFS-12-550-03	CFS-12-551-03	3 mm
CFS-12-549-04	CFS-12-550-04	CFS-12-551-04	4 mm
CFS-12-549-05	CFS-12-550-05	CFS-12-551-05	5 mm
CFS-12-549-06	CFS-12-550-06	CFS-12-551-06	6 mm
CFS-12-549-07	CFS-12-550-07	CFS-12-551-07	7 mm
CFS-12-549-08	CFS-12-550-08	CFS-12-551-08	8 mm

11.5 cm 13.5 cm 17 cm - 6 3/4"

CFS-12-552-02	CFS-12-553-02	CFS-12-554-02	2 mm
CFS-12-552-03	CFS-12-553-03	CFS-12-554-03	3 mm
CFS-12-552-04	CFS-12-553-04	CFS-12-554-04	4 mm
CFS-12-552-05	CFS-12-553-05	CFS-12-554-05	5 mm
CFS-12-552-06	CFS-12-553-06	CFS-12-554-06	6 mm
CFS-12-552-07	CFS-12-553-07	CFS-12-554-07	7 mm
CFS-12-552-08	CFS-12-553-08	CFS-12-554-08	8 mm

11.5 cm 13.5 cm 17 cm - 6 3/4"

Bone Chisels and Gouges

Knochenmeißel

Cinceles, gubias

Ciseaux-burins, gouges

Bone scalpelli e Sgorbie



Lambotte

CFS-12-555-06	CFS-12-556-06	6 mm
CFS-12-555-08	CFS-12-556-08	8 mm
CFS-12-555-10	CFS-12-556-10	10 mm
CFS-12-555-13	CFS-12-556-13	13 mm
CFS-12-555-15	CFS-12-556-15	15 mm
CFS-12-555-20	CFS-12-556-20	20 mm
CFS-12-555-25	CFS-12-556-25	25 mm
CFS-12-555-30	CFS-12-556-30	30 mm
CFS-12-555-38	CFS-12-556-38	38 mm
CFS-12-555-44	CFS-12-556-44	44 mm
CFS-12-555-50	CFS-12-556-50	50 mm

25 cm - 9 3/4"

25 cm - 9 3/4"



Alexander

CFS-12-557-04	CFS-12-558-04	4 mm
CFS-12-557-06	CFS-12-558-06	6 mm
CFS-12-557-08	CFS-12-558-08	8 mm
CFS-12-557-10	CFS-12-558-10	10 mm
CFS-12-557-12	CFS-12-558-12	12 mm
CFS-12-557-14	CFS-12-558-14	14 mm

18 cm - 7"

18 cm - 7"



Mini-Lambotte

CFS-12-555-03	CFS-12-560-03	3 mm
CFS-12-555-04	CFS-12-560-04	4 mm
CFS-12-555-06	CFS-12-560-06	6 mm
CFS-12-555-08	CFS-12-560-08	8 mm
CFS-12-555-10	CFS-12-560-10	10 mm
CFS-12-555-12	CFS-12-560-12	12 mm
CFS-12-555-15	CFS-12-560-15	15 mm

12.5 cm - 5"

17 cm - 6 3/4"

Bone Chisels and Gouges

Knochenmeißel

Cinceles, gubias

Ciseaux-burins, gouges

Bone scalpelli e Sgorbie



Lexer

CFS-12-561-07	CFS-12-562-07	CFS-12-563-07	CFS-12-564-07	7 mm
CFS-12-561-10	CFS-12-562-10	CFS-12-563-10	CFS-12-564-10	10 mm
CFS-12-561-15	CFS-12-562-15	CFS-12-563-15	CFS-12-564-15	15 mm
CFS-12-561-20	CFS-12-562-20	CFS-12-563-20	CFS-12-564-20	20 mm
CFS-12-561-25	CFS-12-562-25	CFS-12-563-25	CFS-12-564-25	25 mm
CFS-12-561-30	CFS-12-562-30	CFS-12-563-30	CFS-12-564-30	30 mm

22 cm - 8 3/4" 30 cm - 12"

Ferrozell handle
 Ferrozellgrif
 Mango en Ferrozell
 Manche en Ferrozell
 Manico di Ferrozell

Mini-Lexer

CFS-12-565-04	CFS-12-566-04	4 mm
CFS-12-565-06	CFS-12-566-06	6 mm
CFS-12-565-08	CFS-12-566-08	8 mm
CFS-12-565-10	CFS-12-566-10	10 mm
CFS-12-565-12	CFS-12-566-12	12 mm

18 cm - 7" 18 cm - 7"

Ferrozell handle
 Ferrozellgrif
 Mango en Ferrozell
 Manche en Ferrozell
 Manico di Ferrozell



Dahmen

CFS-12-200-04	CFS-12-201-04	CFS-12-202-04	CFS-12-203-04	4 mm
CFS-12-200-05	CFS-12-201-05	CFS-12-202-05	CFS-12-203-05	5 mm
CFS-12-200-06	CFS-12-201-06	CFS-12-202-06	CFS-12-203-06	6 mm
CFS-12-200-08	CFS-12-201-08	CFS-12-202-08	CFS-12-203-08	8 mm
CFS-12-200-10	CFS-12-201-10	CFS-12-202-10	CFS-12-203-10	10 mm
CFS-12-200-12	CFS-12-201-12	CFS-12-202-12	CFS-12-203-12	12 mm
CFS-12-200-25	CFS-12-201-15	CFS-12-202-25	CFS-12-203-15	15 mm
CFS-12-200-20	CFS-12-201-20	CFS-12-202-20	CFS-12-203-20	20 mm
CFS-12-200-22	CFS-12-201-22	CFS-12-202-22	CFS-12-203-22	22 mm
CFS-12-200-25	CFS-12-201-25	CFS-12-202-25	CFS-12-203-25	25 mm

30 cm - 11 3/4"

Osteotomes
straight

30 cm - 11 3/4"

Osteotomes
angled

30 cm - 11 3/4"

Gouges
straight

30 cm - 11 3/4"

Gouges
angled

Ferrozell handle

Ferrozellgrif

Mango en Ferrozell

Manche en Ferrozell

Manico di Ferrozell



Zielke

CFS-12-204-05	5.5 mm
CFS-12-204-09	9 mm

23 cm - 9"

Gouges

Ferrozell handle

Ferrozellgrif

Mango en Ferrozell

Manche en Ferrozell

Manico di Ferrozell



Bone Chisels and Gouges

Knochenmeißel

Cinceles, gubias

Ciseaux-burins, gouges

Bone scalpelli e Sgorbie



Cobb

CFS-12-205-27

CFS-12-205-27A

CFS-12-205-27B

CFS-12-205-27C

27 cm - 10 3/4"

8 mm

- Ferrozell handle
- Ferrozellgrif
- Mango en Ferrozell
- Manche en Ferrozell
- Manico di Ferrozell

Bone Chisels and Gouges

Knochenmeißel

Cinceles, gubias

Ciseaux-burins, gouges

Bone scalpelli e Sgorbie



Danis

CFS-12-206-06	CFS-12-207-06	CFS-12-208-06	CFS-12-209-06	6 mm
CFS-12-206-09	CFS-12-207-09	CFS-12-208-09	CFS-12-209-09	9 mm
CFS-12-203-13	CFS-12-207-13	CFS-12-208-13	CFS-12-209-13	13 mm
CFS-12-206-16	CFS-12-207-16	CFS-12-208-16	CFS-12-209-16	16 mm
CFS-12-206-25	CFS-12-207-25	CFS-12-208-25	CFS-12-209-25	25 mm
CFS-12-206-32	CFS-12-207-32	CFS-12-208-32	CFS-12-209-32	32 mm

27.5 cm - 10 3/4"
Osteotomes
straight

27.5 cm - 10 3/4"
Osteotomes
curved

27.5 cm - 10 3/4"
Gouges
straight

27.5 cm - 10 3/4"
Gouges
curved



Capener

CFS-12-210-04	CFS-12-211-04	CFS-12-212-04	6 mm
CFS-12-210-05	CFS-12-211-05	CFS-12-212-05	9 mm
CFS-12-210-06	CFS-12-211-06	CFS-12-212-06	10 mm
CFS-12-210-08	CFS-12-211-08	CFS-12-212-08	11 mm
CFS-12-210-10	CFS-12-211-10	CFS-12-212-10	13 mm
CFS-12-210-12	CFS-12-211-12	CFS-12-212-12	15 mm
CFS-12-210-25	CFS-12-211-15	CFS-12-212-15	16 mm
CFS-12-210-20	CFS-12-211-20	CFS-12-212-20	19 mm
CFS-12-210-22	CFS-12-211-22	CFS-12-212-22	20 mm
CFS-12-210-25	CFS-12-211-25	CFS-12-212-25	25 mm
CFS-12-210-22	CFS-12-211-22	CFS-12-212-22	30 mm
CFS-12-210-25	CFS-12-211-25	CFS-12-212-25	32 mm

23.5 cm - 9 1/4"
Gouges

23.5 cm - 9 1/4"
Gouges

25 cm - 10"
Gouges

Ferrozell handle
Ferrozellgrif
Mango en Ferrozell
Manche en Ferrozell
Manico di Ferrozell

Bone Chisels and Gouges

Knochenmeißel

Cinceles, gubias

Ciseaux-burins, gouges

Bone scalpelli e Sgorbie



Stille

CFS-12-567-10	CFS-12-568-10	CFS-12-569-10	CFS-12-570-10	CFS-12-571-10	10 mm
CFS-12-567-15	CFS-12-568-15	CFS-12-569-15	CFS-12-570-15	CFS-12-571-15	15 mm
CFS-12-567-20	CFS-12-568-20	CFS-12-569-20	CFS-12-570-20	CFS-12-571-20	20 mm
CFS-12-567-25	CFS-12-568-25	CFS-12-569-25	CFS-12-570-25	CFS-12-571-25	25 mm
					20 cm - 8"



Smith-Petersen

CFS-12-572-06	CFS-12-573-06	CFS-12-574-06	CFS-12-575-06	6 mm
CFS-12-572-09	CFS-12-573-09	CFS-12-574-09	CFS-12-575-09	9 mm
CFS-12-572-13	CFS-12-573-13	CFS-12-574-13	CFS-12-575-13	13 mm
CFS-12-572-16	CFS-12-573-16	CFS-12-574-16	CFS-12-575-16	16 mm
CFS-12-572-19	CFS-12-573-19	CFS-12-574-19	CFS-12-575-19	19 mm
CFS-12-572-25	CFS-12-573-25	CFS-12-574-25	CFS-12-575-25	25 mm
CFS-12-572-32	CFS-12-573-32	CFS-12-574-32	CFS-12-575-32	32 mm
				20 cm - 8"



Hibbs

CFS-12-576-06	CFS-12-577-06	CFS-12-578-06	CFS-12-579-06	CFS-12-580-06	6 mm
CFS-12-576-13	CFS-12-577-13	CFS-12-578-13	CFS-12-579-13	CFS-12-580-13	13 mm
CFS-12-576-19	CFS-12-577-19	CFS-12-578-19	CFS-12-579-19	CFS-12-580-19	19 mm
CFS-12-576-25	CFS-12-577-25	CFS-12-578-25	CFS-12-579-25	CFS-12-580-25	25 mm
CFS-12-576-32	CFS-12-577-32	CFS-12-578-32	CFS-12-579-32	CFS-12-580-32	32 mm
					24 cm - 9 1/2"



Freer

CFS-12-581-15

15 cm - 6"
6 mm

Gouge
Hohlmeißel
Cinzel
Gouge
Sgorbio



Freer

CFS-12-582-16

16 cm - 6 1/4"
4 mm

Chisel
Flachmeißel
Cinzel
Ciseau-burin
Scalpello



Ballenger

CFS-12-583-03 4 mm

CFS-12-583-04 6 mm

CFS-12-583-06 8 mm

16 cm - 6 1/4"



**Mannerfelt
modif.**

CFS-12-584-03 CFS-12-585-03 3 mm

CFS-12-584-04 CFS-12-585-04 4 mm

CFS-12-584-06 CFS-12-585-06 6 mm

CFS-12-584-08 CFS-12-585-08 8 mm

15.5 cm - 6"

Osteotomes
Osteotome
Osteótomos
Ostéotomes
Osteotomi

15.5 cm - 6"

Gouge
Hohlmeißel
Gubia
Gouge
Sgorbio

Bone Chisels and Gouges

Knochenmeißel

Cinceles, gubias

Ciseaux-burins, gouges

Bone scalpelli e Sgorbie

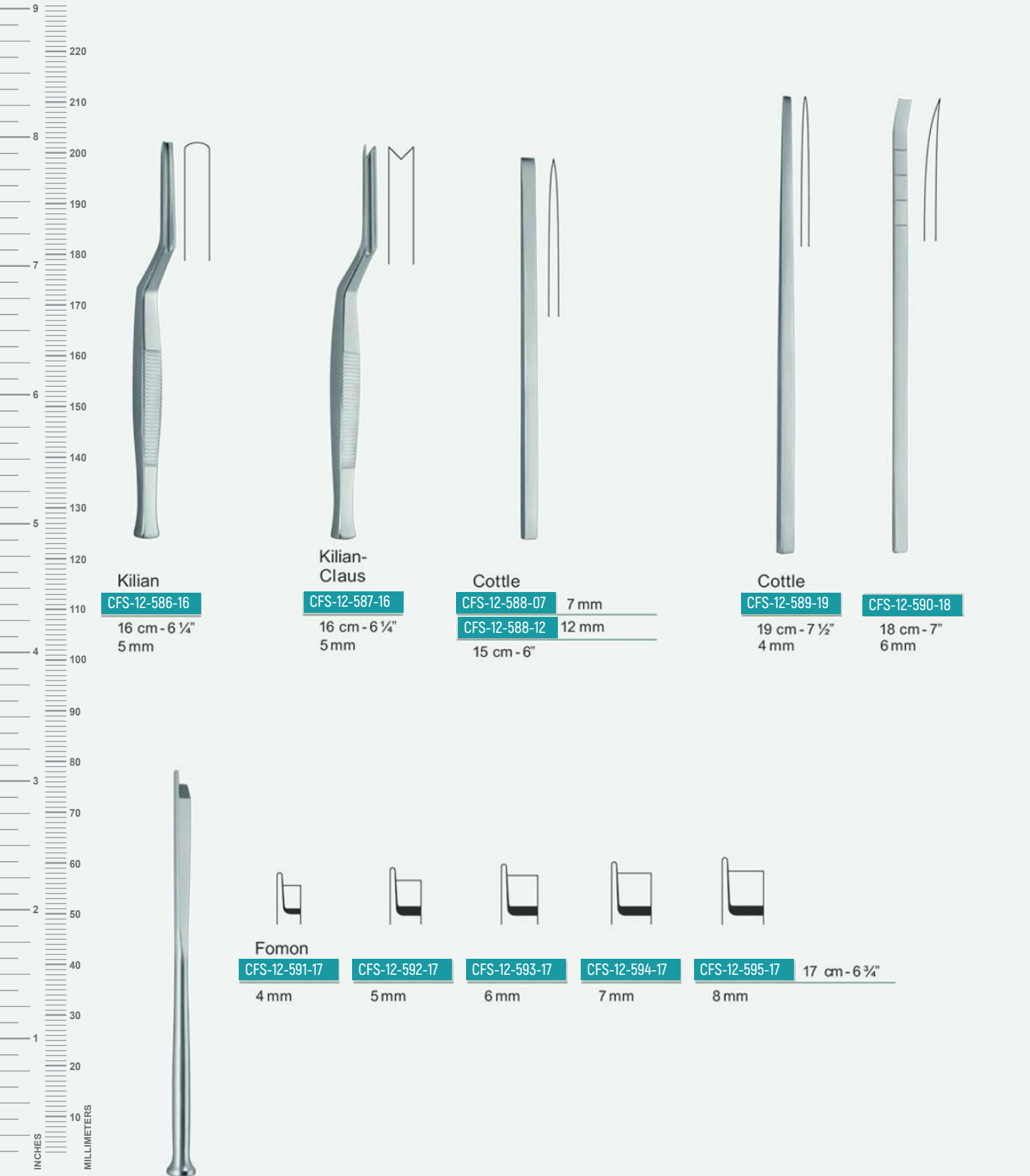

Kilian
CFS-12-586-16
 16 cm - 6 1/4"
 5 mm



Kilian-Claus
CFS-12-587-16
 16 cm - 6 1/4"
 5 mm



Cottle
CFS-12-588-07 7 mm
CFS-12-588-12 12 mm
 15 cm - 6"



Cottle
CFS-12-589-19
 19 cm - 7 1/2"
 4 mm



CFS-12-590-18
 18 cm - 7"
 6 mm



Fomon
CFS-12-591-17 4 mm
CFS-12-592-17 5 mm
CFS-12-593-17 6 mm
CFS-12-594-17 7 mm
CFS-12-595-17 8 mm
 17 cm - 6 3/4"

Bone Chisels and Gouges

Knochenmeißel

Cinceles, gubias

Ciseaux-burins, gouges

Bone scalpelli e Sgorbie

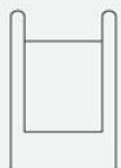

Cinelli

CFS-12-596-18

10 mm



CFS-12-597-18

12 mm

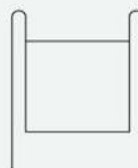

CFS-12-598-18

14 mm

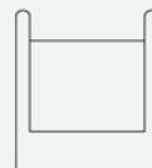

CFS-12-599-18

16 mm

18 cm - 7"



Cottle

CFS-12-600-18

4 mm



CFS-12-601-18

7 mm



CFS-12-602-18

9 mm



CFS-12-603-18

12 mm

18 cm - 7"



Cottle

CFS-12-604-18

4 mm



CFS-12-605-18

7 mm



CFS-12-606-18

9 mm



CFS-12-607-18

12 mm

18 cm - 7"



Bone Chisels and Gouges

Knochenmeißel

Cinceles, gubias

Ciseaux-burins, gouges

Bone scalpelli e Sgorbie



Cottle

CFS-12-608-18

6 mm

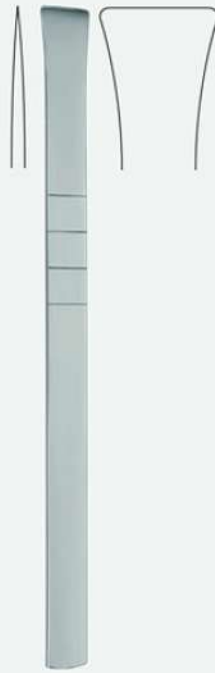

CFS-12-609-18

16 mm



CFS-12-610-20

18 cm - 7"

16 mm



Rubin

CFS-12-611-18

10 mm



CFS-12-612-18

12 mm

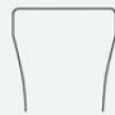

CFS-12-613-20

18 cm - 7"

14 mm

Bone Chisels and Gouges

Knochenmeißel

Cinceles, gubias

Ciseaux-burins, gouges

Bone scalpelli e Sgorbie

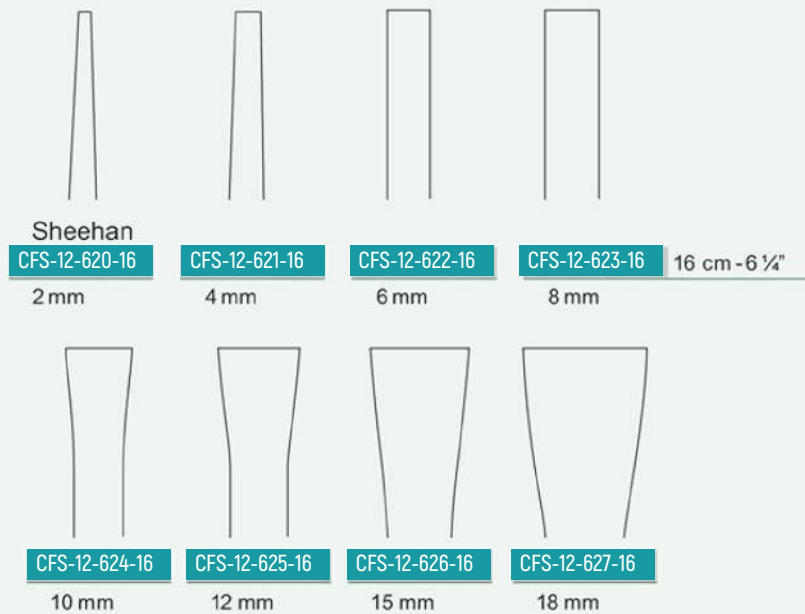
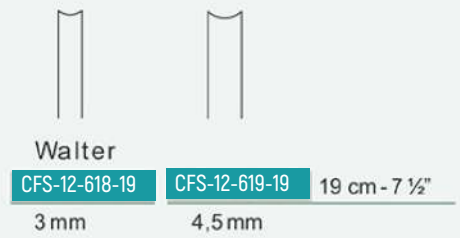

Bone Chisels and Gouges

Knochenmeißel

Cinceles, gubias

Ciseaux-burins, gouges

Bone scalpelli e Sgorbie

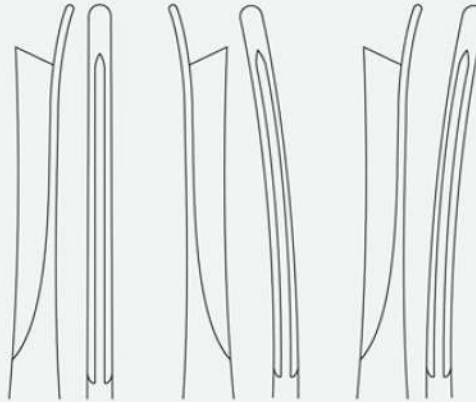

Silver

CFS-12-628-18

straight
gerade
recta
droit
retta

CFS-12-629-18

right
rechts
derecha
droite
destra

CFS-12-630-18

left
links
izquierda
gauche
sinistra

18 cm - 7"

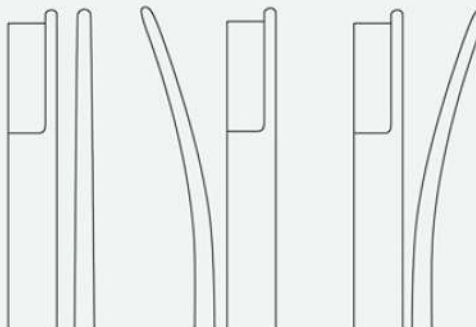

Neivert-Anderson

CFS-12-631-18

straight
gerade
recta
droit
retta

CFS-12-632-18

right
rechts
derecha
droite
destra

CFS-12-633-20

left
links
izquierda
gauche
sinistra

20 cm - 8"

Bone Chisels and Gouges

Knochenmeißel

Cinceles, gubias

Ciseaux-burins, gouges

Bone scalpelli e Sgorbie



Obwegeser

CFS-12-634-21

23.5 cm - 9 1/4"

11 mm



Obwegeser

CFS-12-635-21

7 mm

CFS-12-636-21

10 mm

21.5 cm - 8 1/2"

Ferrozell handle

Ferrozellgrif

Mango en Ferrozell

Manche en Ferrozell

Manico di Ferrozell



Temper

CFS-12-637-15	CFS-12-638-15	CFS-12-639-15	CFS-12-640-15	CFS-12-641-15	CFS-12-642-15	CFS-12-643-15	15.5 cm - 6"
2 mm Ø	3 mm Ø	4 mm Ø	5 mm Ø	6 mm Ø	8 mm Ø	10 mm Ø	

Passow

CFS-12-644-12	CFS-12-645-12	12 cm - 4 3/4"
Fig.1 2.5 mm x 2.5 mm	Fig.2 3.5 mm x 3.5 mm	

Caspar

CFS-12-646-20	CFS-12-647-20	CFS-12-648-20	20 cm - 8"
3 mm Ø	5 mm Ø	8 mm Ø	

Ferrozell handle
Ferrozellgrif
Mango en Ferrozell
Manche en Ferrozell
Manico di Ferrozell

Temper Modified

CFS-12-649-20	CFS-12-650-20	CFS-12-651-20	20 cm - 8"
12 mm Ø	14 mm Ø	16 mm Ø	

Ferrozell handle
Ferrozellgrif
Mango en Ferrozell
Manche en Ferrozell
Manico di Ferrozell

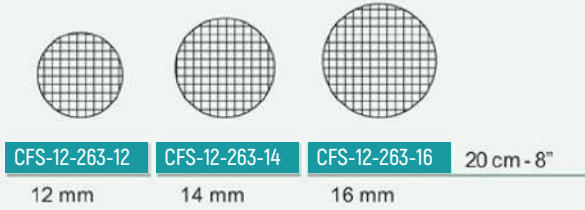
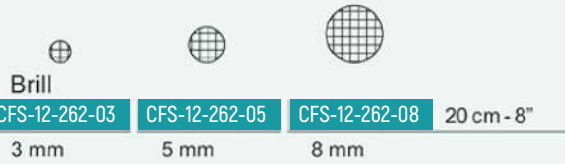

Ferrozell handle
Ferrozellgrif
Mango en Ferrozell
Manche en Ferrozell
Manico di Ferrozell

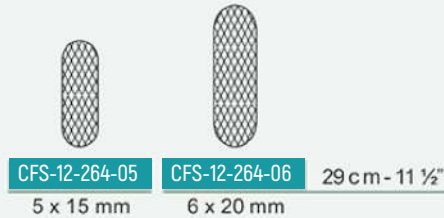



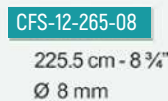
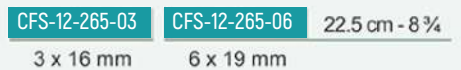
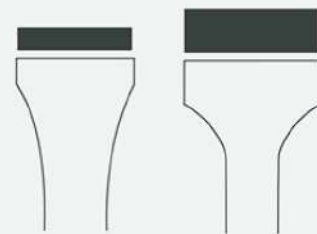
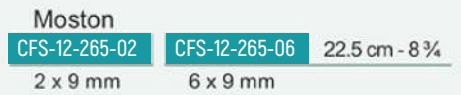
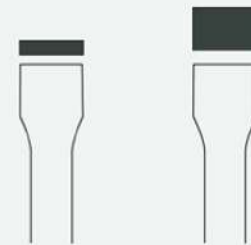







Ferrozell handle
Ferrozellgrif
Mango en Ferrozell
Manche en Ferrozell
Manico di Ferrozell









Volkmann

					
CFS-12-652-17	CFS-12-653-17	CFS-12-654-17	CFS-12-655-17	CFS-12-656-17	17 cm - 6 3/4"
Fig.0000	Fig.000	Fig.00	Fig.0	Fig.1	









					
CFS-12-657-17	CFS-12-658-17	CFS-12-659-17	CFS-12-660-17	CFS-12-661-17	17 cm - 6 3/4"
Fig.2	Fig.3	Fig.4	Fig.5	Fig.6	

Schede









					
CFS-12-662-17	CFS-12-663-17	CFS-12-664-17	CFS-12-665-17	CFS-12-666-17	17 cm - 6 3/4"
Fig.000	Fig.00	Fig.0	Fig.1	Fig.2	

		
CFS-12-667-17	CFS-12-668-17	17 cm - 6 3/4"
Fig.3	Fig.4	



Spratt			
			
CFS-12-669-17	CFS-12-670-17	CFS-12-671-17	17 cm - 6 3/4"
Fig.0000	Fig.000	Fig.00	
			
CFS-12-672-17	CFS-12-673-17	CFS-12-674-17	17 cm - 6 3/4"
Fig.0	Fig.1	Fig.2	
			
CFS-12-675-17	CFS-12-676-17	CFS-12-677-17	17 cm - 6 3/4"
Fig.3	Fig.4	Fig.5	



Bruns			
			
CFS-12-678-16	CFS-12-679-16	CFS-12-680-16	16 cm - 6 1/4"
Fig.000	Fig.00	Fig.0	
			
CFS-12-681-16	CFS-12-682-16	CFS-12-683-16	16 cm - 6 1/4"
Fig.1	Fig.2	Fig.3	
			
CFS-12-684-16	CFS-12-685-16	CFS-12-686-16	
Fig.4	Fig.5	Fig.6	



Volkman

CFS-12-687-18	CFS-12-688-18	CFS-12-689-18	CFS-12-690-18	CFS-12-691-18	CFS-12-692-18	18.5 cm - 7 1/4"
Fig.0000	Fig.000	Fig.00	Fig.0	Fig.1	Fig.2	

CFS-12-693-19	CFS-12-694-19	CFS-12-695-19	CFS-12-696-19	19 cm - 7 1/2"
Fig.3	Fig.4	Fig.5	Fig.6	

CFS-12-697-27	CFS-12-698-27	CFS-12-699-27	CFS-12-700-27	CFS-12-701-27	27.5 cm - 10 3/4"
Fig.0	Fig.1	Fig.2	Fig.3	Fig.4	

oval, Ferrozell handle
 oval, Ferrozellgrif
 ovalada, Mango en Ferrozell
 ovale, Manche en Ferrozell
 ovale, Manico di Ferrozell

Bruns

CFS-12-213-43	CFS-12-214-43	CFS-12-215-43	CFS-12-216-43	43 cm - 17"
CFS-12-213-50	CFS-12-214-50	CFS-12-215-50	CFS-12-216-50	50 cm - 19 3/4"
2 mm	3 mm	3 mm	6 mm	

Epstein

CFS-12-217-43	CFS-12-218-43	43 cm - 17"
CFS-12-217-50	CFS-12-218-50	50 cm - 19 3/4"
3 mm	6 mm	

Scoville

CFS-12-219-50	50 cm - 19 3/4"
9 mm	

Cone

CFS-12-220-43	CFS-12-221-43	43 cm - 17"
CFS-12-220-50	CFS-12-221-50	50 cm - 19 3/4"
Ø 3 mm	Ø 6 mm	





Halle

CFS-12-702-21 CFS-12-703-21 CFS-12-704-21 21 cm - 8 1/4"

Fig. 1
 flexible
 flexibel
 flexible
 flexible
 flessibile

Fig.2

Fig.3



Tenorde

CFS-12-705-17

Fig.1



CFS-12-706-17

17 cm - 6 3/4"

Fig.2

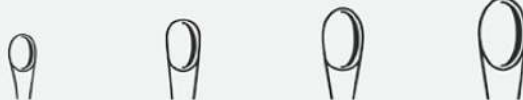

Bruns

CFS-12-707-23 CFS-12-708-23 CFS-12-709-23 CFS-12-710-23 23 cm - 9"

Fig.00

Fig.0

Fig.1

Fig.2



CFS-12-711-23

Fig.3

CFS-12-712-23

Fig.4

CFS-12-713-23

Fig.5

CFS-12-714-23

Fig.6

solid
 massiv
 macizo
 solide
 massiccio

23 cm - 9"



Bone Curettes

Scharfe Löffel
Cucharillas Cortantes
Curettes Tranchantes
Curette Bone



Schroeder
CFS-12-715-30

Fig. 1



CFS-12-716-30

Fig. 2



CFS-12-717-30

Fig. 3

30 cm - 12"



CFS-12-718-30

Fig. 4



CFS-12-719-30

Fig. 5



CFS-12-720-30

Fig. 6

30 cm - 12"

sharp / rigid
scharf / fest
tranchante / rigide
cortante / rigida
tagliente / rigido

CFS-12-701-27



Simon
CFS-12-721-24

Fig. 0000



CFS-12-722-24

Fig. 0000



CFS-12-723-24

Fig. 00



CFS-12-724-24

Fig. 0

24 cm - 9 1/2"

sharp / rigid
scharf / fest
cortante / rigida
tranchante / rigide
tagliente / rigido



Simon
CFS-12-725-25

Fig. 1



CFS-12-726-25

Fig. 2



CFS-12-727-25

Fig. 3

25 cm - 9 3/4"



CFS-12-728-25

Fig. 4



CFS-12-729-25

Fig. 5



CFS-12-730-25

Fig. 6

25 cm - 9 3/4"

sharp / rigid
scharf / fest
cortante / rigida
tranchante / rigide
tagliente / rigido



Akson			
CFS-12-731-20	CFS-12-732-20	CFS-12-733-20	20 cm - 8"
Fig.000	Fig.00	Fig.0	

CFS-12-734-20	CFS-12-735-20	CFS-12-736-20	20 cm - 8"
Fig.1	Fig.2	Fig.3	

CFS-12-737-20	CFS-12-738-20	CFS-12-739-20	20 cm - 8"
Fig.4	Fig.5	Fig.6	

Fig.4
straight
gerade
recta
droit
retto



CFS-12-740-20	CFS-12-741-20	CFS-12-742-20	20 cm - 8"
Fig.000	Fig.00	Fig.0	

CFS-12-743-20	CFS-12-744-20	CFS-12-746-20	20 cm - 8"
Fig.1	Fig.2	Fig.3	

CFS-12-747-20	CFS-12-748-20	CFS-12-749-20	20 cm - 8"
Fig.4	Fig.5	Fig.6	

Fig.4
curved
gebogen
courbe
curva
curvo



Miguel				
CFS-12-750-25	CFS-12-751-25	CFS-12-752-25	CFS-12-753-25	25 cm - 9 3/4"
Fig.000	Fig.00	Fig.0	Fig.1	
3.6 mm	4.4 mm	5.2 mm	6.8 mm	

Fig.000
3.6 mm
straight
gerade
recta
droit
retto

Daubenspeck				
CFS-12-754-20	CFS-12-755-20	CFS-12-757-20	CFS-12-758-20	20 cm - 8"
Fig.0000	Fig.000	Fig.00	Fig.0	
2.8 mm	3.6 mm	4.4 mm	5.2 mm	





Scoville

CFS-12-759-25

CFS-12-760-25

CFS-12-761-25

25 cm - 9 3/4"

Fig.1

Fig.2

Fig.3

oval
 oval
 ovalada
 ovale
 ovale



CFS-12-701-27

Lempert

CFS-12-762-21

CFS-12-763-21

CFS-12-764-21

CFS-12-765-21

CFS-12-766-21

21.5 cm - 8 1/2"

Fig.00000
 1.8 mm

Fig.0000
 2.0 mm

Fig.000
 2.4 mm

Fig.00
 2.6 mm

Fig.0
 2.8 mm





Bruns

○	CFS-12-251-01 3.3 mm	CFS-12-251-02 3.3 mm	CFS-12-251-03 3.3 mm	Fig. 000	23 cm - 9"
○	CFS-12-252-01 3.9 mm	CFS-12-253-02 3.9 mm	CFS-12-254-03 3.9 mm	Fig. 00	23 cm - 9"
○	CFS-12-255-01 4.7 mm	CFS-12-255-02 4.7 mm	CFS-12-255-03 4.7 mm	Fig. 0	23 cm - 9"
○	CFS-12-256-01 5.3 mm	CFS-12-256-02 5.3 mm	CFS-12-256-03 5.3 mm	Fig. 1	23 cm - 9"
○	CFS-12-257-01 6 mm	CFS-12-257-02 6 mm	CFS-12-257-03 6 mm	Fig. 2	23 cm - 9"
○	CFS-12-258-01 7.2 mm	CFS-12-258-02 7.2 mm	CFS-12-258-03 7.2 mm	Fig. 3	23 cm - 9"
○	CFS-12-259-01 8.2 mm	CFS-12-259-02 8.2 mm	CFS-12-259-03 8.2 mm	Fig. 4	23 cm - 9"
○	CFS-12-260-01 9.8 mm	CFS-12-260-02 9.8 mm	CFS-12-260-03 9.8 mm	Fig. 5	23 cm - 9"
○	CFS-12-261-01 12 mm	CFS-12-261-02 12 mm	CFS-12-261-03 12 mm	Fig. 6	23 cm - 9"

CFS-12-749-20

Bone Currettes

Scharfe Löffel

Cucharillas Cortantes

Currettes Tranchantes

Curette Bone



Volkman
Fig. 1

- CFS-12-767-13
- CFS-12-767-14
- CFS-12-767-16
- CFS-12-767-17
- CFS-12-767-20

oval/oval
oval/oval
ovalada/ovalada
ovale/ovale
ovale/ovale



Fig. 2

- | | |
|---------------|----------------|
| CFS-12-768-13 | 13 cm - 5" |
| CFS-12-768-14 | 14 cm 5 1/2" |
| CFS-12-768-16 | 16 cm - 6 1/4" |
| CFS-12-768-17 | 17 cm - 6 3/4" |
| CFS-12-768-20 | 20 cm - 8" |

round/oval
rund/oval
redonda/ovalada
ronde/ovale
rotondo/ovale



Fig. 3

- CFS-12-769-21

21 cm - 8 1/4"
round/oval
rund/oval
redonda/ovalada
ronde/ovale
rotondo/ovale



Martini

CFS-12-770-13

Fig.00
Fig.0



CFS-12-771-13

Fig.0
Fig.1



CFS-12-772-13

Fig.1
Fig.2

13.5 cm - 5 1/4"



Martini

CFS-12-773-15

Fig.00
Fig.0



CFS-12-774-15

Fig.0
Fig.0

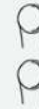

CFS-12-775-15

Fig. 1
Fig. 1

15.5 cm 6"



Williger

CFS-12-776-13

Fig.00
Fig.0



CFS-12-777-13

Fig.0
Fig.1



CFS-12-778-13

Fig.1
Fig.2

13.5 cm 5 1/4"



Williger

CFS-12-779-13

Fig.00
Fig.00



CFS-12-780-13

Fig.0
Fig.0



CFS-12-781-13

Fig. 1
Fig. 1

15.5 cm - 6"

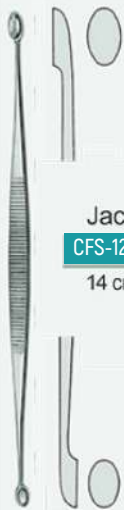

Jacobson

CFS-12-262-14

14 cm - 5 1/2"

Bone Curettes

Scharfe Löffel

Cucharillas Cortantes

Curettes Tranchantes

Curette Bone



Obwegeser

CFS-12-782-17

6 mm

CFS-12-783-17

7 mm

CFS-12-784-17

9 mm

CFS-12-785-17

11 mm

17 cm - 6 3/4"



CFS-12-786-20

5 mm

CFS-12-787-20

8 mm

CFS-12-788-20

9 mm

20 cm - 8"



Obwegeser-Freer

CFS-12-789-21

21 cm - 8 1/4"



Obwegeser-Freer

CFS-12-790-21

21 cm - 8 1/4"



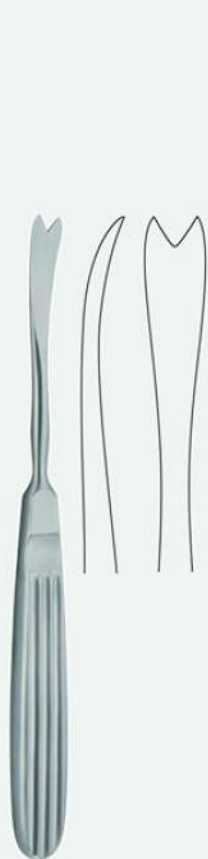

Obwegeser
CFS-12-791-17
17.5 cm - 7"



CFS-12-778-13

Obwegeser
CFS-12-792-23
23 cm - 9"



Obwegeser
CFS-12-793-18
18 cm - 7"



Obwegeser
CFS-12-794-14
14 cm - 5 1/2"





Doyen

CFS-12-795-17 17 cm - 6 3/4"

for adults left
für Erwachsene links
para adultos izquierda
pour adultes gauche
per adulti sinistra



CFS-12-796-17 17 cm - 6 3/4"

for children left
für Kinder links
para niños izquierda
pour enfants gauche
per bambini sinistra



Doyen

CFS-12-797-17 17 cm - 6 3/4"

for adults right
für Erwachsene rechts
para adultos derecha
pour adultes droite
per adulti destra



CFS-12-798-17 17 cm - 6 3/4"

for children right
für Kinder rechts
para niños derecha
pour enfants droite
per bambini destra



Quervain

CFS-12-799-15
19.5 cm - 7 3/4"
x = 6 mm



Trelat

CFS-12-800-15
15 cm - 6"
x = 8 mm



König

CFS-12-801-15
x = 4.5 mm



CFS-12-802-15 15.5 cm - 6"
x = 4.5 mm



Williger
 CFS-12-803-15
 15.5 cm - 6"



Alderdyce
 CFS-12-804-21
 21 cm - 8 1/4"

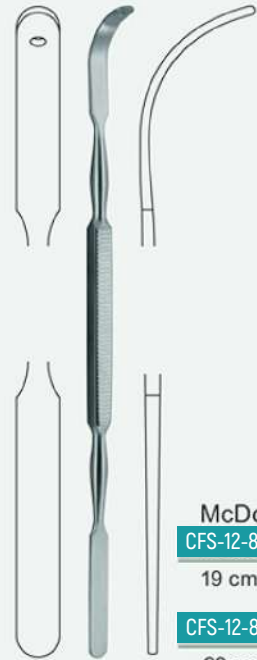

McDonald
 CFS-12-805-19
 19 cm - 7 1/2"
 CFS-12-805-23
 23 cm - 9"
 Less curved
 Without hole



Sedillot
 CFS-12-806-18 18.5 cm - 7 1/4"
 CFS-12-806-21 21 cm - 8 1/4"

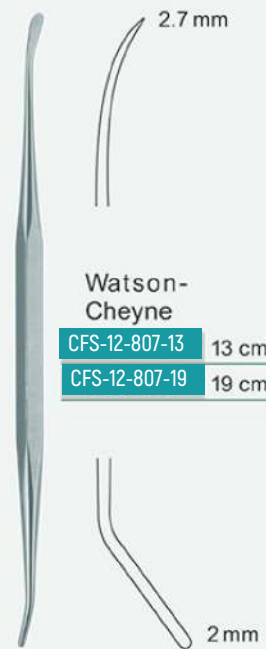

Watson-Cheyne
 CFS-12-807-13 13 cm - 5 1/4"
 CFS-12-807-19 19 cm - 7 1/2"

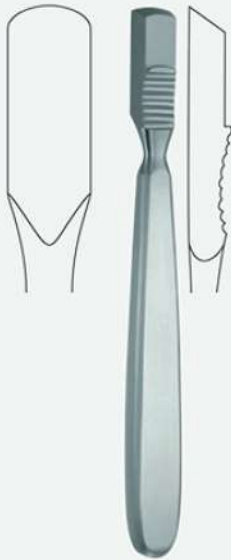

Farabeuf

CFS-12-808-15

straight
gerade
recta
droit
retto



CFS-12-809-15

15 cm - 6"

curved
gebogen
curva
courbe
curvo

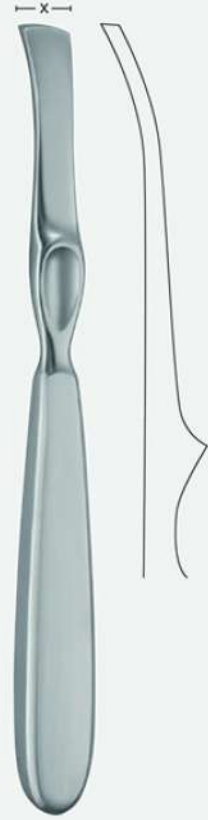

Lambotte

CFS-12-810-05 x = 5 mm

CFS-12-810-10 x = 10 mm

CFS-12-810-15 x = 15 mm

CFS-12-810-20 x = 20 mm

CFS-12-810-25 x = 25 mm

21 cm - 8 1/4"



Adson

CFS-12-811-17

Fig.1



CFS-12-812-17

Fig.2



CFS-12-813-17

Fig.3



CFS-12-814-17

Fig.4

17 cm - 6 3/4"



Williger
CFS-12-815-13 13 cm - 5"
 x = 5 mm



Williger
CFS-12-816-16 x = 4 mm
CFS-12-817-16 x = 6 mm
 16 cm - 6 1/4"
 CFS-12-778-13



Williger
CFS-12-818-16
 x = 5 mm



CFS-12-819-16 16 cm - 6 1/4"
 x = 6.5 mm



Farabeuf-Collin
CFS-12-820-16
 x = 11 mm



CFS-12-821-16 16 cm - 6 1/4"
 x = 11 mm

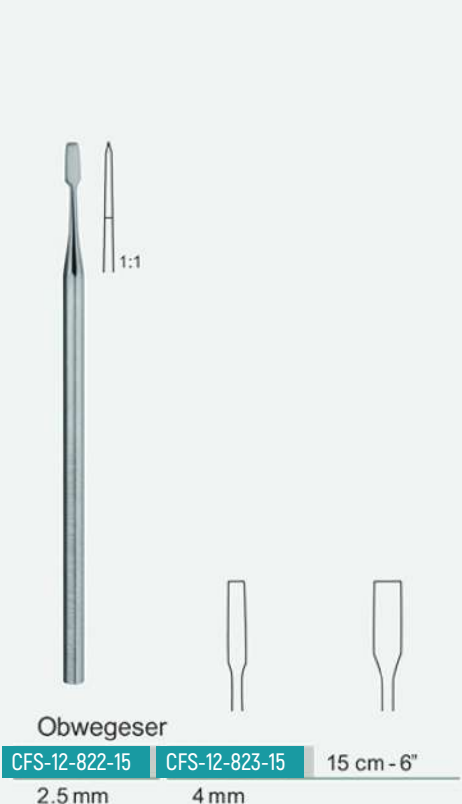

Semb
 CFS-12-826-17
 17.5 cm - 7"
 12 mm



CFS-12-827-21
 21 cm - 8 1/4"
 12 mm



CFS-12-828-21
 17.5 cm - 7"
 13 mm



CFS-12-829-21
 21 cm - 8 1/4"
 13 mm



CFS-12-830-22
 22.5 cm - 8 3/4"
 13 mm



CFS-12-831-22
 22.5 cm - 8 3/4"
 15 mm





Howarth
CFS-12-832-21
 21.5 cm - 8 1/2"
 sharp / blunt
 scharf / stumpf
 aguda / roma
 pointu / mousse
 acuta / smussa



Langenbeck
CFS-12-833-18
 18 cm - 7"



Langenbeck
CFS-12-834-19
 19 cm - 7 1/2"

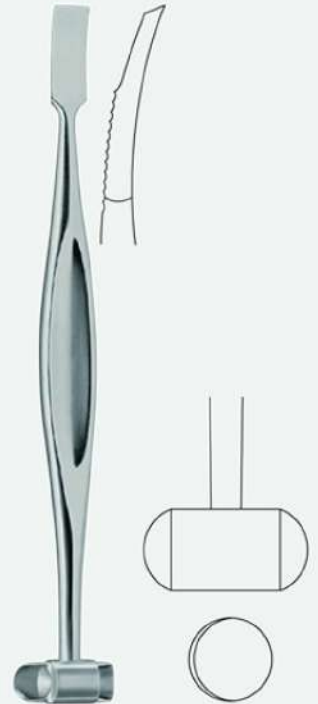

Alexander
CFS-12-835-20
 20 cm - 8"



Langenbeck
CFS-12-836-20
 x = 8 mm
 20 cm - 8"



Langenbeck
CFS-12-837-20
 x = 10 mm
 20 cm - 8"



Sebileau
CFS-12-838-17 17.5 cm - 7"
 x = 5 mm



extremely light
 extrem leicht
 estremamente ligero
 extrêmement léger
 estremamente leggera

Maxon
CFS-12-839-17 17.5 cm - 7"



Schneider
CFS-12-222-17
 17.5 cm - 7"
 13 mm



Schneider-Sauerbruch
CFS-12-223-19
 19 cm - 7 1/2"
 13 mm



Jansen
CFS-12-224-16
 16.5 cm - 6 1/2"
 15 mm



Cushing
CFS-12-225-19
 19.5 cm - 7 3/4"
 5 mm

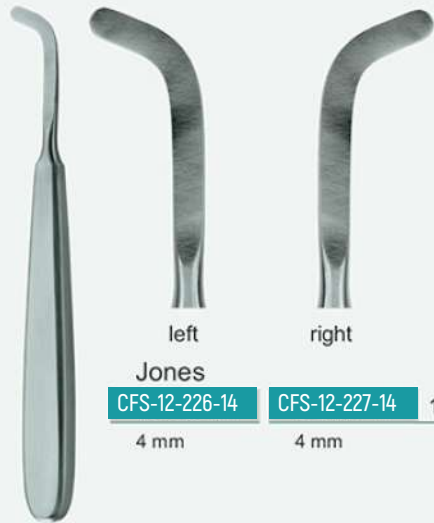

Jones
CFS-12-226-14 **CFS-12-227-14** 14 cm - 5 1/2"
 4 mm 4 mm



Cushing-Hopkins
 CFS-12-228-19
 19 cm - 7 1/2"



Jones Modified
 CFS-12-229-06 6 mm
 CFS-12-229-08 8 mm
 17 cm - 6 3/4"



Casper
 CFS-12-23018 CFS-12-231-18 18 cm - 7"
 sharp blunt
 6,2 mm 6,2 mm





Mühling

CFS-12-232-17	CFS-12-233-17	17 cm - 6 3/4"
4 mm	4 mm	
CFS-12-234-17	CFS-12-235-17	17 cm - 6 3/4"
4 mm	6 mm	

Adson

CFS-12-236-05	CFS-12-237-05	5 mm
CFS-12-236-07	CFS-12-237-07	7 mm
16.5 cm - 6 1/2"	16.5 cm - 6 1/2"	
straight	curved	

Manerfelt

CFS-12-238-03	CFS-12-239-03	CFS-12-240-03	CFS-12-241-03	3 mm
CFS-12-238-04	CFS-12-239-04	CFS-12-240-04	CFS-12-241-04	4 mm
CFS-12-238-06	CFS-12-239-06	CFS-12-240-06	CFS-12-241-06	6 mm
CFS-12-238-07	CFS-12-239-07	CFS-12-240-07	CFS-12-241-07	7 mm
CFS-12-238-08	CFS-12-239-08	CFS-12-240-08	CFS-12-241-08	8 mm
CFS-12-238-09	CFS-12-239-09	CFS-12-240-09	CFS-12-241-09	9 mm
15.5 cm - 6"				

CFS-12-242-03	CFS-12-243-03	CFS-12-244-03	3.5 mm
CFS-12-242-04	CFS-12-243-04	CFS-12-244-04	4 mm
CFS-12-242-05	CFS-12-243-05	CFS-12-244-05	5 mm
CFS-12-242-06	CFS-12-243-06	CFS-12-244-06	6 mm
15.5 cm - 6"			



angled, sharp
 Vally
CFS-12-245-45 43 cm - 17" 45°
CFS-12-245-90 43 cm - 17" 90°

Cobb
CFS-12-246-06
 43 cm - 17" 6 mm

CFS-12-247-06
 50 cm - 19 3/4" 6 mm

CFS-12-247-10
 50 cm - 19 3/4" 10 mm

CFS-12-247-13
 50 cm - 19 3/4" 13 mm



Cobb

CFS-12-840-29	x = 10 mm
CFS-12-841-29	x = 13 mm
CFS-12-842-29	x = 19 mm

29 cm - 11 1/2"

Spinal raspatory
Wirbelsäulen-Raspatorium
Rugine vertebral
Raspatorio vertebral
Periostotomo vertebral



Key

CFS-12-843-18	CFS-12-844-19	CFS-12-845-19
18 cm - 7"	19 cm - 7 1/2"	19 cm - 7 1/2"
x = 6 mm	x = 10 mm	x = 12 mm



CFS-12-846-20
20 cm - 8"
x = 19 mm

CFS-12-847-21
21 cm - 8 1/4"
x = 25 mm



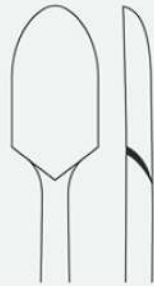

Steger Round

CFS-12-848-20

Fig. 1
14 mm
straight
gerade
droit
recta
rette

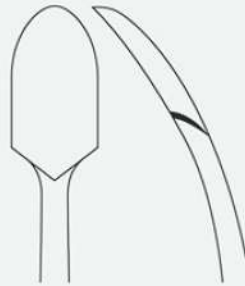

CFS-12-849-20

Fig. 2
14 mm
curved
gebogen
courbe
curva
curve



CFS-12-850-20 20 cm - 8"

Fig. 3
20 mm
gerade
straight
droit
recta
rette

Ferrozell handle
Ferrozellgrif
Manche en Ferrozell
Mango en Ferrozell
Manico di Ferrozell

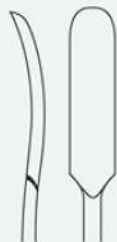

Steger Slim

CFS-12-851-18

Fig. 1
6 mm
18 cm - 7"



CFS-12-852-18

Fig. 2
3 mm
18 cm - 7"

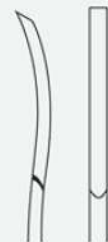

CFS-12-853-18

Fig. 3
6 mm
18 cm - 7"

Ferrozell handle
Ferrozellgrif
Manche en Ferrozell
Manico di Ferrozell



Steger Angled

CFS-12-248-19

19 cm - 7 1/2"
angled
13 mm

CFS-12-249-19

19 cm - 7 1/2"
straight
13 mm



Hohmann
CFS-12-854-22
 22 cm - 8 3/4"
 x = 8 mm



CFS-12-855-22
 24 cm - 9 1/2"
 x = 18 mm



CFS-12-856-24
 24 cm - 9 1/2"
 x = 43 mm



CFS-12-857-24
 24 cm - 9 1/2"
 x = 70 mm



Hohmann

CFS-12-858-24

24.5 cm - 9 3/4"
x = 43 mm

CFS-12-859-26

26 cm - 10 1/4"
x = 22 mm

CFS-12-860-28

28 cm - 11"
x = 33 mm

CFS-12-861-26

26.5 cm - 10 1/2"
x = 24 mm

CFS-12-862-26

26 cm - 10 1/4"
x = 22 mm



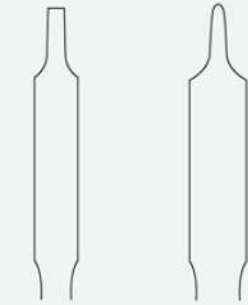

Mini-Hohmann

CFS-12-863-16

CFS-12-864-16

16 cm - 6 1/4"

6 mm

8 mm

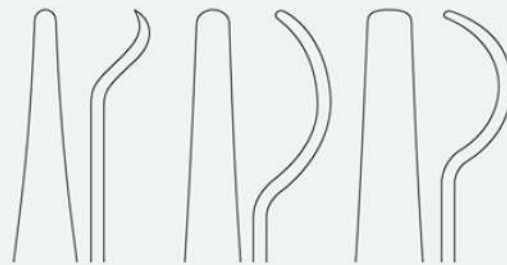

Curvy

CFS-12-865-14

CFS-12-866-14

CFS-12-867-14

14 cm - 5 1/2"

2.8 mm

4.5 mm

6 mm



Bristow

CFS-12-868-23

23 cm - 9"



Lane

CFS-12-869-21

21 cm - 8 1/4"

Bone Levers

Knochenhebel

Elevadores para huesos

Levires a os

Leve ossee

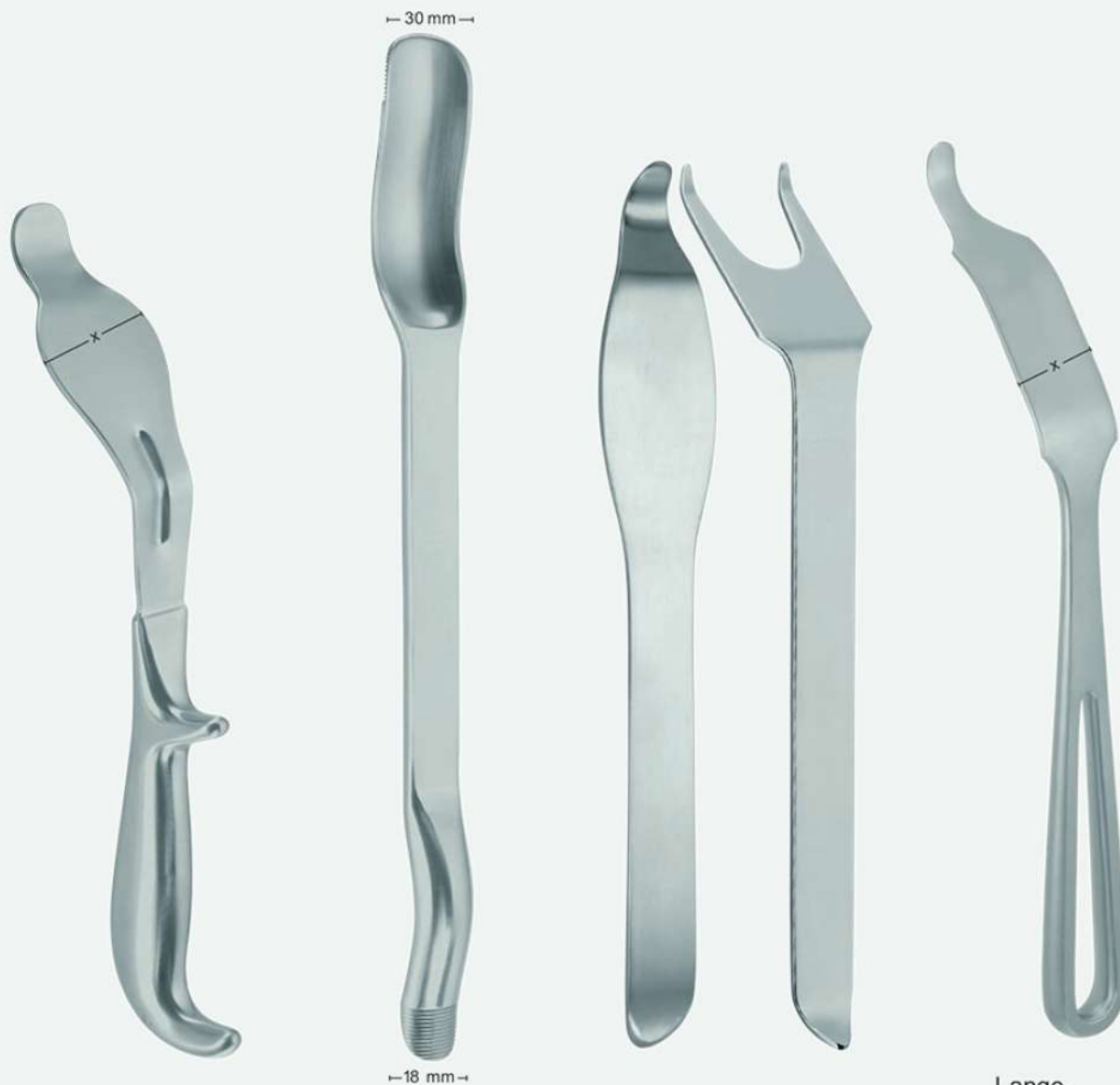

Bennett

CFS-12-870-24 x = 43 mm

CFS-12-871-24 x = 60 mm

24 cm - 9 1/2"

Murphy-Lane

CFS-12-872-34

34 cm - 13 1/2"

Luxation lever
Luxationshebel
Palanca de luxación
Levier de luxation
Leva per luxazione

Blount

CFS-12-873-26

Lane

CFS-12-874-26

26 cm - 10 1/4"

Lange-Hohmann mod.

CFS-12-875-26

CFS-12-876-28

26.5 cm - 10 1/2" 28 cm - 11"
x = 30 mm x = 33 mm





Hohmann-Williger
CFS-12-877-16
 16 cm - 6 1/4"

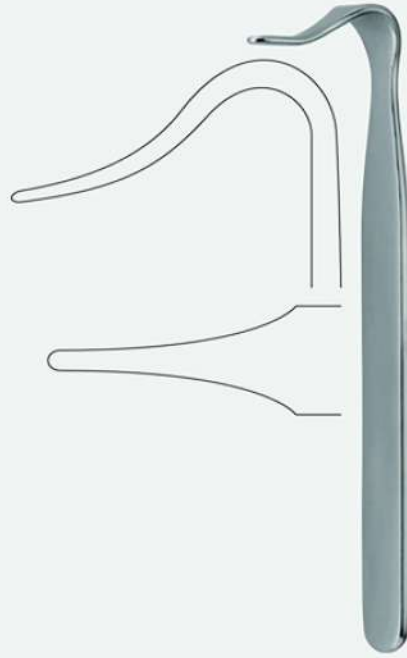

Blount
CFS-12-878-17
 17.5 cm - 7"



Taylor
CFS-12-879-16 a = 75 mm - b = 30 mm
CFS-12-880-16 a = 100 mm - b = 30 mm
 16.5 cm - 6 1/2"

Meniscotomy knives
 Meniskotome
 Bisturías para meniscos
 Bistouries à ménisques
 Coltelli Meniscotomy



Bircher
CFS-12-881-19
 19 cm - 7 1/2"



Smillie
CFS-12-882-17
 17 cm - 6 3/4"
 Fig. 1



CFS-12-883-17
 17 cm - 6 3/4"
 Fig. 2



CFS-12-884-17
 17 cm - 6 3/4"
 Fig. 3

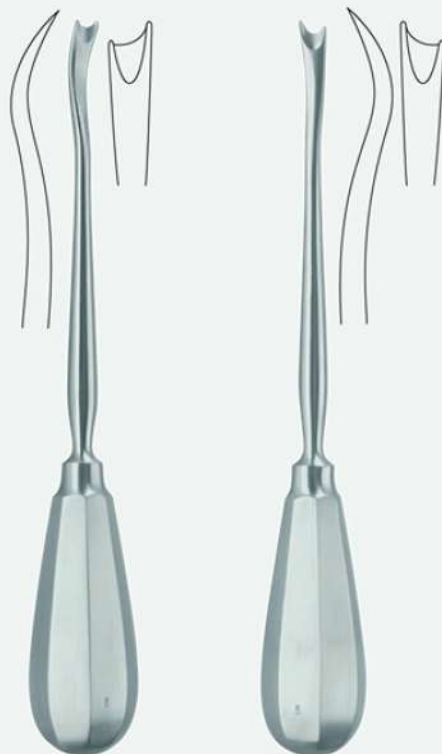

Kanadisches Modell

CFS-12-885-20

Fig. 1

CFS-12-886-20 20 cm - 8"

Fig. 2



Neff

CFS-12-887-22

left
 links
 izquierda
 gauche
 sinistra



CFS-12-888-22

22 cm - 8 3/4"

right
 rechts
 derecha
 droit
 destra



Nilcon

CFS-12-889-18

18 cm - 7"





Wixon

CFS-12-890-23	CFS-12-891-23	CFS-12-892-23	23 cm - 9"
4.0 mmØ	4.5 mmØ	5.5 mmØ	

Malleable shaft
 Schaft biegsam
 Tige malléable
 Tija maleable
 Asta malleabile



Bunnell

CFS-12-893-15	CFS-12-894-15	CFS-12-895-15	15 cm - 6"
Fig.1	Fig.2	Fig.3	
CFS-12-896-15	CFS-12-897-15		
Fig.4	Fig.5		



Fischer

CFS-12-898-31

31 cm - 12 1/4"



Bunnell

CFS-12-899-23

23 cm - 9"

Tendon passer
Sehnen durchzugs sonde
Sonde conductrice pour tendons
Sonda conductora de tendones
Sonda conduttrice per tendini



Kleinert-
Kutz

CFS-12-900-20

20 cm - 8"
20 mm Ø



Tendon holding forceps
 Sehnenfasszangen
 Pinzas para coger tendones
 Pinces pour saisir les tendons
 Tendine tenendo forcipe



Brand

CFS-12-901-15

15 cm - 6"



CFS-12-902-19

19 cm - 7 1/2"



CFS-12-903-24

24 cm - 9 1/2"



Tendon

CFS-12-904-13

13 cm - 5"



Tendon

CFS-12-905-15

15 cm - 6"



CFS-12-906-15

15 cm - 6"



Luer

CFS-12-907-15

Fig. 1
15 cm - 6"



CFS-12-908-15

Fig. 2
15 cm - 6"



Luer

CFS-12-909-17

17 cm - 6 3/4"



CFS-12-910-17

17 cm - 6 3/4"



Blumenthal

CFS-12-911-15

15.5 cm - 6"
Fig. 1



CFS-12-912-15

15.5 cm - 6"
Fig. 2



CFS-12-913-15

15.5 cm - 6"
Fig. 3



Jansen

CFS-12-914-18

18 cm - 7"
Fig. 1



CFS-12-915-18

18 cm - 7"
Fig. 2





Mini-Friedmann
CFS-12-916-12
 12 cm - 4 ¾"



Friedmann
CFS-12-917-14
 14 cm - 5 ½"

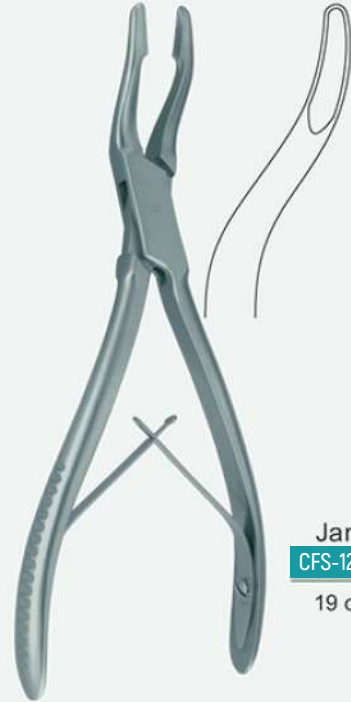

Jansen
CFS-12-918-19
 19 cm - 7 ½"



Adson
CFS-12-919-20
 20 cm - 8"



Bacon
CFS-12-920-21
 21 cm - 8 ¼"



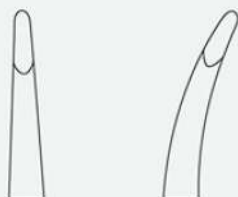

Lempert
CFS-12-921-19 **CFS-12-922-19**
19 cm - 7 1/2" 19 cm - 7 1/2"

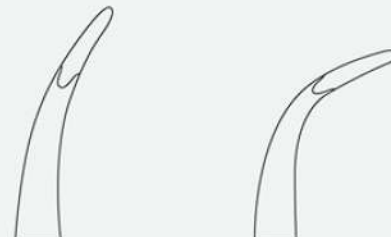

Stellbrink
CFS-12-923-17 **CFS-12-924-17**
17.5 cm - 7" 17.5 cm - 7"
slightly curved strongly curved
leicht gebogen stark gebogen
ligeramente curvada fuertemente curvada
légèrement courbe très courbe
legermente curvata fortemente curvata



Olivecrona
CFS-12-925-20
20.5 cm - 8"



Hartmann
CFS-12-926-17
17.5 cm - 7"



Mead
CFS-12-927-16
 16.5 cm - 6 1/2"



Cleveland
CFS-12-928-17
 17 cm - 6 3/4"



Cleveland
CFS-12-929-14
 14 cm - 5 1/2"



Böhler
CFS-12-930-15 **CFS-12-931-15**
 15 cm - 6" 15 cm - 6"



Zaufal-Jansen
CFS-12-932-18
 18 cm - 7"



Marquardt
CFS-12-933-20
 20 cm - 8"





Beyer
CFS-12-934-18
18 cm - 7"



Ruskin
CFS-12-935-18
18 cm - 7"



CFS-12-936-18
18 cm - 7"



Mayfield
CFS-12-937-17
17.5 cm - 7"



Bone Holding Forceps

Knochenhaltezangen

Pinzas para huesos

Daviers Porte os

Pinza Tenendo Bone

9
220
210
8
200
190
7
180
170
6
160
150
5
140
130
4
100
3
90
80
70
2
60
50
1
40
30
20
10
INCHES
MILLIMETERS



Stille-Ruskin

CFS-12-938-23

CFS-12-939-23

23 cm - 9"

23 cm - 9"



Stille

CFS-12-940-24

CFS-12-941-24

CFS-12-942-24

4 mm
23 cm - 9"

6 mm
23 cm - 9"

8 mm
23 cm - 9"



Leksell

CFS-12-943-24

CFS-12-944-24

CFS-12-945-24

4 mm

6 mm

8 mm

24 cm - 9 1/2"

24 cm - 9 1/2"

24 cm - 9 1/2"



Stille-Luer

CFS-12-946-22

CFS-12-947-22

22 cm - 8 3/4"

22 cm - 8 3/4"



Röttgen-
Ruskin
CFS-12-948-23
 23 cm - 9"

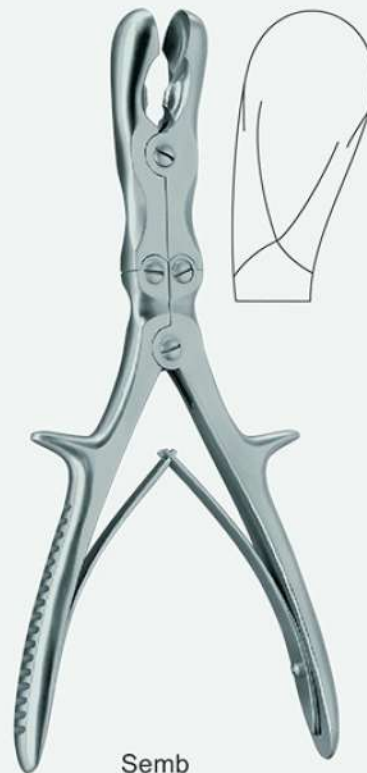

Semb
CFS-12-949-24
 24 cm - 9 1/2"



Echlin
CFS-12-950-23
 23 cm - 9"



CFS-12-951-23
 23 cm - 9"



Frykholm
CFS-12-952-24
 24 cm - 9 1/2"

Bone Holding Forceps

Knochenhaltezangen

Pinzas para huesos

Daviers Porte os

Pinza Tenendo Bone



Sauerbruch

CFS-12-953-30

Fig. 1



CFS-12-954-30

30 cm - 12"

Fig. 2



Luer-Stille

CFS-12-955-27

Fig. 1



CFS-12-956-27

27 cm - 10 3/4"

Fig. 2



Bone Holding Forceps

Knochenhaltezangen

Pinzas para huesos

Daviers Porte os

Pinza Tenendo Bone



Sypert

CFS-12-950-08

36 cm - 14 ¼"
8 mm



CFS-12-950-12

36 cm - 14 ¼"
12 mm



Bone Holding Forceps

Knochenhaltezaugen

Pinzas para huesos

Daviers Porte os

Pinza Tenendo Bone



Cottle-Kazanjan
CFS-12-957-19
 19 cm - 7 1/2"



Liston

CFS-12-958-14	CFS-12-959-14	14 cm - 5 1/2"
CFS-12-958-17	CFS-12-959-17	17 cm - 6 3/4"
CFS-12-958-19	CFS-12-959-19	19 cm - 7 1/2"
CFS-12-958-22	CFS-12-959-22	22 cm - 8 3/4"



Bohler

CFS-12-960-16	CFS-12-961-16
15 cm - 6" Fig. 1	15 cm - 6" Fig. 2



Ruskin-Liston

CFS-12-962-18	CFS-12-963-18
18.5 cm - 7 1/4" Fig. 1	18.5 cm - 7 1/4" Fig. 2

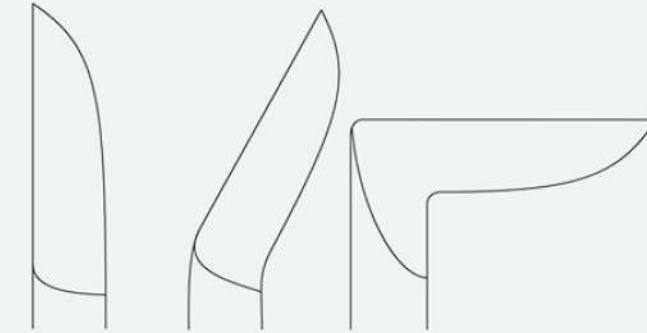

Stille-Liston

CFS-12-964-27

CFS-12-965-27

CFS-12-966-27

27 cm - 10 3/4"

Fig. 1

Fig. 2

Fig. 3



Semb

CFS-12-967-24

24 cm - 9 1/2"



Liston-Key Horsley

CFS-12-968-27

27 cm - 10 3/4"



Bone Holding Forceps

Knochenhaltezangen

Pinzas para huesos

Daviers Porte os

Pinza Tenendo Bone



Gerster-Lowmann

CFS-12-969-18	18 cm - 7"	x = 28 mm
CFS-12-969-20	20 cm - 8"	x = 35 mm
CFS-12-969-22	22 cm - 8 3/4"	x = 40 mm

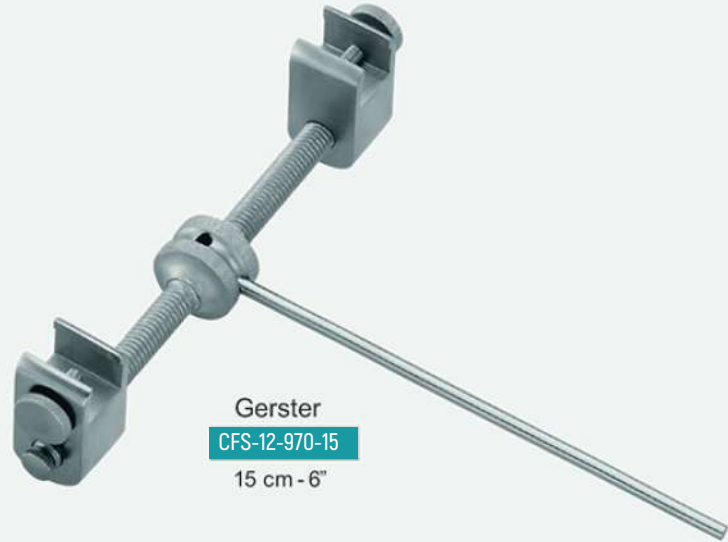

Gerster

CFS-12-970-15

15 cm - 6"

Bone holding forceps – Reposition forceps
 Knochenhaltezaugen – Repositionszangen
 Pinzas para huesos – Pinzas para reposición
 Daviers porte-os – Pincas de reposition
 Tenendo pinza Bone - Riposizionare forcipe

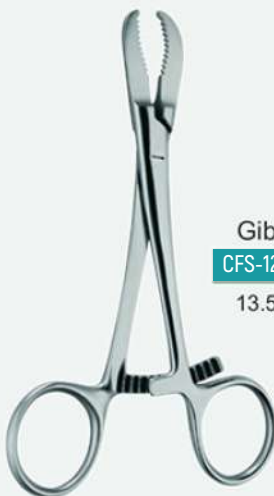

Gibway

CFS-12-971-13

13.5 cm - 5 1/4"



Lewin

CFS-12-972-17

17.5 cm - 7"



Henry

CFS-12-973-14

14 cm - 5 1/2"

Bone Holding Forceps

Knochenhaltezaugen

Pinzas para huesos

Daviers Porte os

Pinza Tenendo Bone



Bone Holding Forceps

Knochenhaltezangen

Pinzas para huesos

Daviers Porte os

Pinza Tenendo Bone

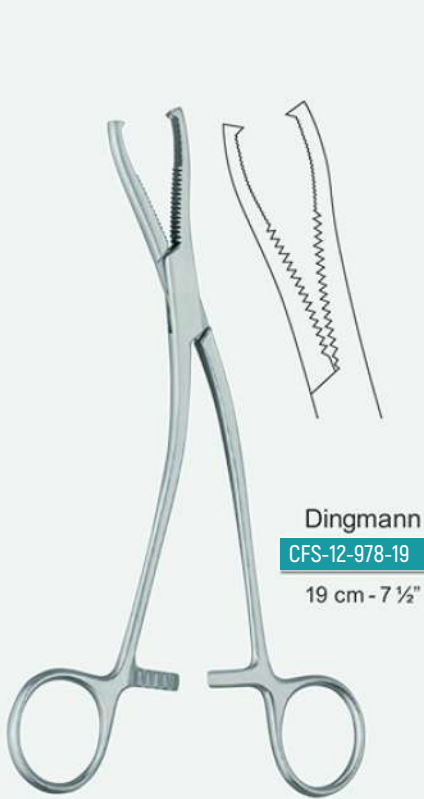

Bone Holding Forceps

Knochenhaltezaugen

Pinzas para huesos

Daviers Porte os

Pinza Tenendo Bone



Martin
CFS-12-984-19
19 cm - 7 1/2"

CFS-12-934-18



Bircher-Ganske
CFS-12-985-20 CFS-12-986-20 20 cm - 8"



Hey Groves

CFS-12-987-21	21 cm - 8 1/4"	x = 6.5 mm
CFS-12-987-27	27 cm - 10 3/4"	x = 7.5 mm
CFS-12-987-30	30.5 cm - 12"	x = 8.5 mm



Bone Holding Forceps

Knochenhaltezaugen

Pinzas para huesos

Daviers Porte os

Pinza Tenendo Bone



Verbrugge

CFS-12-988-17

17.5 cm - 7"
x = 5.0 mm

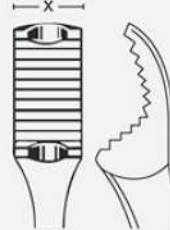

CFS-12-989-25

25 cm - 10"
x = 9.5 mm

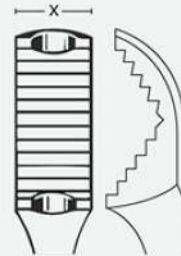

CFS-12-990-26

26 cm - 10 1/4"
x = 10.5 mm

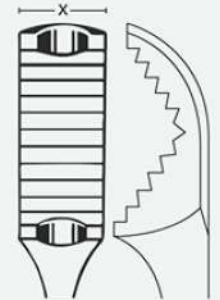

CFS-12-991-27

27 cm - 10 3/4"
x = 12.0 mm



Kern

CFS-12-992-17 17 cm - 6 3/4"

CFS-12-992-21 21 cm - 8 1/4"



Kern

CFS-12-993-17 17 cm - 6 3/4"

CFS-12-993-21 21 cm - 8 1/4"

Self-retaining

www.cureflexsurgical.com



Bone Holding Forceps

Knochenhaltezaugen

Pinzas para huesos

Daviers Porte os

Pinza Tenendo Bone



Lane

CFS-12-995-33 33 cm - 13"

CFS-12-995-45 45 cm - 17 ¾"



Lane

CFS-12-994-33 33 cm - 13"

CFS-12-994-45 45 cm - 17 ¾"

Self-retaining

Bone Holding Forceps

Knochenhaltezangen

Pinzas para huesos

Daviers Porte os

Pinza Tenendo Bone



Lambotte

CFS-12-996-22	22 cm - 8 3/4"
CFS-12-996-27	27 cm - 10 3/4"
CFS-12-996-30	30 cm - 12"

one jaw mobile
ein Maulteil beweglich
una boca movable
un mors mobile
una parte del morso mobile



Lumbart

CFS-12-997-15	15 cm - 6"	x = 2.5 mm
CFS-12-997-19	19 cm - 7 1/2"	x = 6.5 mm
CFS-12-997-24	24 cm - 9 1/2"	x = 9.5 mm
CFS-12-997-26	26 cm - 10 1/4"	x = 10.0 mm
CFS-12-997-28	28 cm - 11"	x = 11.0 mm

self-centering
selbstzentrierend
autocentrante
auto-centreur
autocentrante

Bone Holding Forceps

Knochenhaltezaugen

Pinzas para huesos

Daviers Porte os

Pinza Tenendo Bone

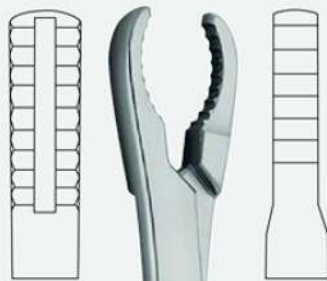

Ulrich

CFS-12-998-23	CFS-12-999-23	23 cm - 9"
CFS-12-998-25	CFS-12-999-25	25 cm - 9 ¾"
CFS-12-998-28	CFS-12-999-28	28 cm - 11"

angular
kniegebogen
acodada
coudée
angolata



Carl

CFS-12-100-16	16 cm - 6 ¼"
CFS-12-100-24	24 cm - 9 ½"



Bone Holding Forceps

Knochenhaltezangen

Pinzas para huesos

Daviers Porte os

Pinza Tenendo Bone



Minipal
CFS-12-101-13
13.5 cm - 5 1/4"



Reill
CFS-12-102-17
17 cm - 6 3/4"



Hogan
CFS-12-103-20
20 cm - 8"



Sadle
CFS-12-104-13
13.5 cm - 5"
for maxillary reposition
für Kieferreposition
para reposición mandibular
pour reposition mandibulaire
per riposizione mandibulare



Haase
CFS-12-105-16

16.5 cm - 6 1/2"

for mandibular fractures
für Unterkieferfrakturen
para fracturas del mandibulo
pour fractures mandibulaires
per fratture mandibulare

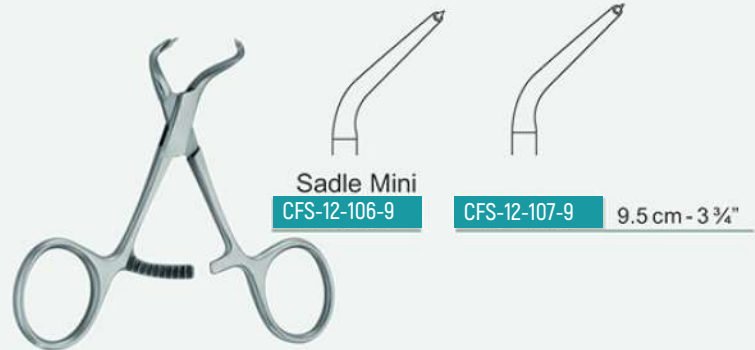

Sadle Mini
CFS-12-106-9

CFS-12-107-9 9.5 cm - 3 3/4"



Patella
CFS-12-108-18

18.5 cm - 7 1/4"



Malleolar
CFS-12-109-21

21 cm - 8 1/4"





Demel
 CFS-12-110-32 x = 32 mm
 CFS-12-110-45 x = 45 mm
 CFS-12-110-62 x = 62 mm
 28 cm - 11"



Demel
 CFS-12-111-28
 28 cm - 11"



CFS-12-934-18

Loute

CFS-12-112-21

21 cm - 8 1/4"



Tightner

CFS-12-113-13

13 cm - 5"



CFS-12-114-01	0.2 mm Ø
CFS-12-114-02	0.3 mm Ø
CFS-12-114-03	0.4 mm Ø
CFS-12-114-04	0.5 mm Ø
CFS-12-114-05	0.6 mm Ø
CFS-12-114-06	0.7 mm Ø
CFS-12-114-07	0.8 mm Ø
CFS-12-114-08	0.9 mm Ø
CFS-12-114-09	1.0 mm Ø
CFS-12-114-10	1.2 mm Ø
CFS-12-114-11	1.5 mm Ø

Bone wire, soft, in coils of 10 m
 Knochendraht, weich, in Ringen à 10 m
 Alambre de cerclaje, blando, de 10 m
 Fil de cerclage, souple, de 10m
 Filo per ossa, morbida, anelli da 10 m



CFS-12-115-01 0.8 mmØ x280 mm

CFS-12-115-02 1.0 mmØ x 280 mm

CFS-12-115-03 1.2 mmØ x 280 mm

CFS-12-115-04 1.0 mmØ x600 mm

CFS-12-115-05 1.2 mmØ x600 mm



Bone wire with eye, soft, package of 10 pieces
 Knochendraht mit Auge, weich, Packung à 10 Stück
 Alambre de cerclaje, blando, paquete de 10 piezas
 Fil de cerclage, souple, paquet de 10 pièces
 Filo per ossa con ansa, morbida, pacchetto di 10 pezzi



Heft
CFS-12-116-22 22 cm - 8 3/4"

for hard wires up to 2.2 mm Ø, for soft wires up to 3 mm Ø
für harte Drähte bis 2.2 mm Ø, für weiche Drähte bis 3 mm Ø
para alambres duros hasta 2.2 mm Ø, y alambres blandos de 3 mm Ø
pour fils durs à diam. 2.2 mm Ø, pour fils souples à 3 mm Ø
per fili duri fina 2.2 mm Ø, per fili morbidi fino a 3 mm Ø

Taxon
CFS-12-117-22 22 cm - 8 3/4"

for hard wires up to 2.2 mm Ø, for soft wires up to 2.8 mm Ø
für harte Drähte bis 2.2 mm Ø, für weiche Drähte bis 2.8 mm Ø
para alambres duros hasta 2.2 mm Ø, y alambres blandos de 2.8 mm Ø
pour fils durs à 2.2 mm Ø, pour fils souples à 2.8 mm Ø
per fili duri fina 2.2 mm Ø, per fili morbidi fino a 2.8 mm Ø

Kilborn
CFS-12-118-23 CFS-12-118-23 23 cm - 9"

straight curved
for hard wires up to 2.2 mm Ø, for soft wires up to 3 mm Ø
für harte Drähte bis 2.2 mm Ø, für weiche Drähte bis 3 mm Ø
para alambres duros hasta 2.2 mm Ø, y alambres blandos de 3 mm Ø
pour fils durs à 2.2 mm Ø, pour fils souples à 3 mm Ø
per fili duri fina 2.2 mm Ø, per fili morbidi fino a 3 mm Ø



T-Cut
 Fig. 1

CFS-12-119-18 18 cm - 7"

for hard wires up to 1.5 mm Ø, for soft wires up to 2 mm Ø
 für harte Drähte bis 1.5 mm Ø, für weiche Drähte bis 2 mm Ø
 para alambres duros hasta 1.5 mm Ø, y alambres blandos de 2 mm Ø
 pour fils durs à 1.5 mm Ø, pour fils souples à 2 mm Ø
 per fili duri fina 1.5 mm Ø, per fili duri morbidi fino a 2 mm Ø



T-Cut
 Fig. 2

CFS-12-120-18 18 cm - 7"

for hard wires up to 1.7 mm Ø, for soft wires up to 2 mm Ø
 für harte Drähte bis 1.7 mm Ø, für weiche Drähte bis 2 mm Ø
 para alambres duros hasta 1.7 mm Ø, y alambres blandos de 2 mm Ø
 pour fils durs à 1.7 mm Ø, pour fils souples à 2 mm Ø
 per fili fina 1.7 mm Ø, per fili morbidi fino a 2 mm Ø



Gabriel

CFS-12-121-15 15 cm - 6"

for hard wires up to 1 mm Ø, for soft wires up to 1.5 mm Ø
 für harte Drähte bis 1 mm Ø, für weiche Drähte bis 1.5 mm Ø
 para alambres duros hasta 1 mm Ø, y alambres blandos de 1.5 mm Ø
 pour fils durs à 1 mm Ø, pour fils souples à 1.5 mm Ø
 per fili duri fina 1 mm Ø, per fili morbidi fino a 1.5 mm Ø



Zim

CFS-12-122-14 14.5 cm - 5 3/4"

for hard wires up to 1 mm Ø
 für harte Drähte bis 1 mm Ø
 para alambres duros hasta 1 mm Ø
 pour fils durs à 1 mm Ø
 per fili duri fino a 1 mm Ø



Haanna

CFS-12-122-18

18.5 cm - 7 1/4"

soft Ø 2.5mm
 hard Ø 1.5mm

Wire instruments

Draht instrumentarium
Instrumental para cerclaje
Instruments pour cerclage
Strumenti wire



Ultramake
CFS-12-123-57 57 cm - 22 1/2"

for Kirschner wires and Steinmann pins up to 6 mm Ø
für Kirschner Drähte und Steinmann Nägel bis 6 mm Ø
para agujas de Kirschner y clavos de Steinmann hasta 6 mm Ø
pour des broches Kirschner et clous Steinmann à 6 mm Ø
per fili Kirschner e chiodi Steinmann fino a 6 mm Ø



Mochi
CFS-12-124-18 18.5 cm 7 1/4"

Kopfschneider, durchbohrt für harte Drähte bis 1.6 mm Ø
Wire cutting forceps for hard wires up to 1.6 mm Ø
Pince coupante pour fils durs à 1.6 mm Ø
Alicate para alambres duros hasta 1.6 mm Ø
Pinza taglia fili per fili duri fino a 1.6 mm Ø



soft Ø 2 mm
hard Ø 2 mm

Gravity
CFS-12-125-16
16 cm - 6 1/4"



Lionman
CFS-12-125-26 26 cm - 10 1/4"

for hard wires up to 3 mm Ø
für harte Drähte bis 3 mm Ø
para alambres duros hasta 3 mm Ø
pour fils durs à 3 mm Ø
per fili duri fino a 3mm Ø



Passor

CFS-12-126-13 13 cm - 5"

CFS-12-126-18 18 cm - 7"



Flat one

CFS-12-127-14 14 cm - 5 1/2"

CFS-12-127-17 17 cm - 6 3/4"



Flat pro

CFS-12-128-05

CFS-12-129-05 x = 5 mm

CFS-12-128-05

CFS-12-129-07 x = 7 mm

18 cm - 7"

18 cm - 7"



Twison

CFS-12-130-22 22 cm - 8 3/4"

Grip-Zange, kombiniert mit TC-Schneider
 Grip forceps, combined with TC-Cutter
 Pince grip, avec partie coupante TC
 Pinza grip, con parte cortante TC
 Pinza grip, con morso tagliente a TC



Gripper

CFS-12-131-19 19 cm - 7 1/2"

Technische Zange, verstellbar
 Technical forceps, adjustable
 Pince technique, ajustable
 Pinza tecnica, ajustable
 Pinza tecnica, regolabile



Combi

CFS-12-132-17

17 cm - 6 3/4"



Arom - Fig. 1
CFS-12-133-18

18.5 cm - 7 1/4"

Wire bending forceps
 Drahtbiegezange
 Pinza para torcer
 Pince à couder
 Pinza per piegare



Fig. 2
CFS-12-134-18

18.5 cm - 7 1/4"

Flat nose plier, parallel grip, incorporated cutter, for hard wires up to 1.6 mm Ø
 Flachzange mit Seitenschneider, parallelfassend, für harte Drähte bis 1.6 mm Ø
 Pinza para torcer con corte lateral, para alambres hasta 1.6 mm Ø
 Pince à couder avec coupe latéral, pour des fils durs à de 1.6 mm Ø
 Pinza, morso piatto parallelo e taglia fili laterale fino a 1.6 mm Ø



Fixton

- CFS-12-135-18** 18 cm - 7"
- CFS-12-135-20** 20 cm - 8"
- CFS-12-135-24** 24 cm - 9 1/2"

Locking plier
 Feststellzange
 Pinza de fijar
 Pince à caler
 Pinza bloccante



Fixton - Advanced

CFS-12-136-20 20 cm - 8"

Plattenbiegezange für Knochenplatten bis 2.7 mm Stärke
 Plate bending plier for plates up to 2.7 mm
 Pince à couder pour des plaques de 2.7 mm
 Pinza para torcer, placas hasta 2.7 mm
 Pinza piega placche fino a 2.7 mm

CFS-12-137-24 24 cm - 9 1/2"

Plattenbiegezange für Knochenplatten bis 4 mm Stärke
 Plate bending plier for plates up to 4 mm
 Pince à conder pour des plaques de 4 mm
 Pinza para torcer, para placas hasta mm 4
 Pinza piega placche fino a 4 mm





Mayr

CFS-12-138-01 22 cm - 8 3/4"

CFS-12-138-02 25 cm - 9 3/4"

CFS-12-138-03 30 cm - 12"

Locking plier



Extension Bows

Extensionsbugel

Estribos para Extension

Entriers Pour Extension

Archi di estensione

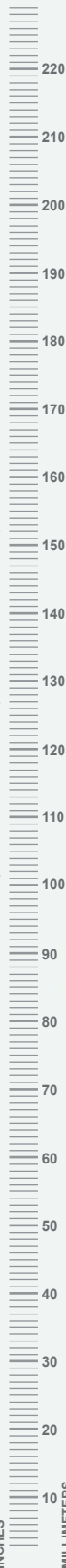

Bow

CFS-12-139-18 18 cm - 7"

Wire strainer for Kirschner wires
Spannschlüssel für Kirschner Drähte
Tensor para agujas de Kirschner
Tendeur pour fils de Kirschner
Chiave per estensione di fili Kirschner

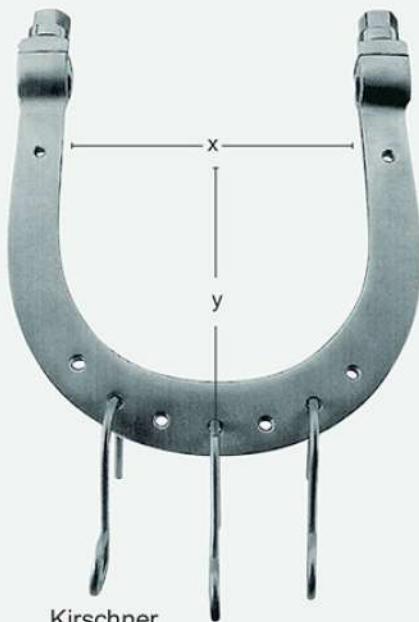

Kirschner

CFS-12-140-01	x = 95 mm	y = 70 mm
CFS-12-140-02	x = 100 mm	y = 100 mm
CFS-12-140-03	x = 120 mm	y = 120 mm
CFS-12-140-04	x = 155 mm	y = 155 mm
CFS-12-140-05	x = 200 mm	y = 155 mm

with 3 traction hooks
mit 3 Zughaken
con 3 ganchos de tracción
avec 3 crochets d'attelage
con 3 ganci di trazione



Kirschner

CFS-12-141-13	x = 130 mm
CFS-12-141-18	x = 185 mm
CFS-12-141-22	x = 220 mm

with 3 traction hooks
mit 3 Zughaken
con 3 ganchos de tracción
avec 3 crochets d'attelage
con 3 ganci di trazione





Kirschner

CFS-12-142-18 x = 180 mm y = 100 mm

CFS-12-142-27 x = 270 mm y = 160 mm

with 3 traction hooks
 mit 3 Zughaken
 con 3 ganchos de tracción
 avec 3 crochets d'attelage
 con 3 ganci di trazione

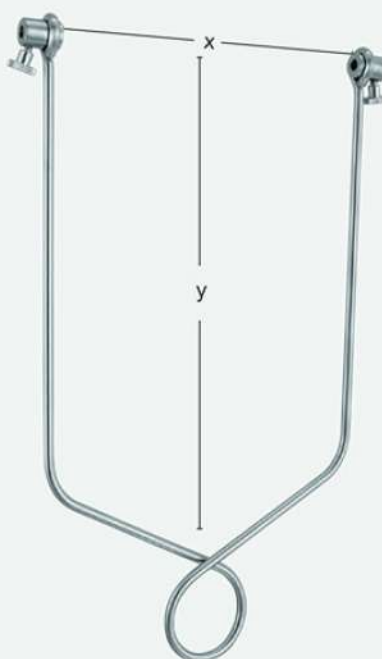

Bohler

CFS-12-143-01 x = 75 mm y = 90 mm

CFS-12-143-02 x = 90 mm y = 160 mm

CFS-12-143-03 x = 110 mm y = 210 mm

CFS-12-143-04 x = 150 mm y = 210 mm



Key

CFS-12-14419 19 cm - 7 1/2"

14 mm / 17 mm
 Wrench
 Gabelschlüssel
 Llave de tuercas
 Clé de serrage
 Chiave per madreviti

Hand Drills

Handbohrapparate
Perforadores de mano
Perforateurs a main
Trapani a mano



Percy

CFS-12-145-22

Handles detachable, simple pattern
Griffe abnehmbar, einfaches Modell
Mango desmontable, modelo simple
Manches à détacher, modèle simple
Manici demontabili, modello semplice



Comprimeter

CFS-12-146-22

Consisting of arm and upper thigh cuff,
manometer calibrated up to 700 mm Hg, with metal pump
Komprimeter, bestehend aus Arm- und Oberschenkelmanschette,
Manometer justiert bis 700 mm Hg und Metallpumpe
Comprímetero, se compuesto de brazalete para brazo y muslo,
manómetro calibrado hasta 700 mm Hg, con bomba metálica
Comprímètre se composant du brassard pour bras et cuisse,
manomètre calibré jusqu'à 700 mm Hg, avec pompe métallique
Comprímetero, composto da torniquete, due bracciali e pompa d'aria
e manometro graduato fino a 700mm Hg



Bunell

CFS-12-147-16 16 cm - 6 1/4"

Opening up to 4 mm Ø
Öffnung bis 4 mm Ø
Apertura hasta 4 mm Ø
Ouverture jusqu'à 4 mm Ø
Apertura fino à 4 mm Ø

Light metal housing
Leichtmetallgehäuse
Carcasa en metal ligero
Carcasse en métal léger
In scatola di alluminio
Longitudinally cannulated
Längsdurchbohrt
Taladrado longitudinalmente
À perforation axiale
Forato longitudinalmente

CFS-12-148-16

Spare key
Ersatzschlüssel
Llave de recambio
Clé de réchange
Chiave di ricambio



Ralk

CFS-12-149-16

16 cm - 6 1/4"

Opening up to 6.35 mm Ø
Öffnung bis 6,35 mm Ø
Apertura hasta 6.35 mm Ø
Ouverture jusqu'à 6.35 mm Ø
Apertura fino à 6.35 mm Ø

Light metal housing
Leichtmetallgehäuse
Carcasa en metal ligero
Carcasse en métal léger
In scatola di alluminio
Longitudinally cannulated
Längsdurchbohrt
Taladrado longitudinalmente
À perforation axiale
Forato longitudinalmente



Hand Drills

Handbohrapparate
 Perforadores de mano
 Perforateurs a main
 Trapani a mano



Stille

CFS-12-150-20
 20 cm - 8"

CFS-12-150-00 complete with 9 twist drills (Fig. 1 – Fig. 9)

Consisting:

CFS-12-150-20	Drill, 20 cm / 8"
CFS-12-150-01	Bur, Fig. 1, 2.5 mm Ø
CFS-12-150-02	Bur, Fig. 2, 3.0 mm Ø
CFS-12-150-03	Bur, Fig. 3, 3.5 mm Ø
CFS-12-150-04	Bur, Fig. 4, 4.0 mm Ø
CFS-12-150-07	Bur, Fig. 7, 8.0 mm Ø
CFS-12-150-08	Bur, Fig. 8, 12.0 mm Ø
CFS-12-150-09	Bur, Fig. 9, 16.0 mm Ø



CFS-12-151-01

Fig.1
 2.5 mmØ



CFS-12-152-02

Fig.2
 3.0 mmØ



CFS-12-153-03

Fig.3
 3.5 mmØ



CFS-12-154-04

Fig.4
 4.0 mmØ



CFS-12-155-07

Fig.7
 8.0 mm Ø



CFS-12-156-08

Fig.8
 12.0 mm Ø



CFS-12-157-09

Fig.9
 16.0 mm Ø



CFS-12-158-10

Fig.10
 1.0 mm Ø



CFS-12-159-11

Fig.11
 1.5 mm Ø



CFS-12-160-12

Fig.12
 2.0 mm Ø



Jacobs

CFS-12-161-28

28 cm - 11"

Opening up to 6.35 mm Ø
Öffnung bis 6,35 mm Ø
Apertura hasta 6.35 mm Ø
Ouverture jusqu'à 6.35 mm Ø
Apertura fino à 6.35 mm Ø



Viva

CFS-12-162-00

Opening up to 6.35 mm Ø
Öffnung bis 6,35 mm Ø
Apertura hasta 6.35 mm Ø
Ouverture jusqu'à 6.35 mm Ø
Apertura fino à 6.35 mm Ø

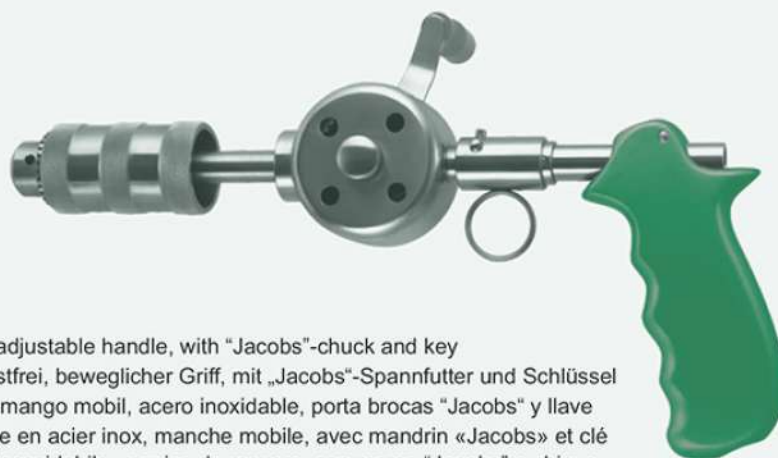

Joanna

CFS-12-163-28

28 cm - 11"

Hand drill, stainless, adjustable handle, with "Jacobs"-chuck and key
Handbohrapparat, rostfrei, beweglicher Griff, mit „Jacobs“-Spannfutter und Schlüssel
Taladradora a mano, mango mobil, acero inoxidable, porta brocas "Jacobs" y llave
Perceuse mécanique en acier inox, manche mobile, avec mandrin «Jacobs» et clé
Perforatore a mano, inossidabile, manico da muovere, con morso "Jacobs" e chiave

