

02

Aspiration-Probes
Aspiration-Sonden
Aspiracion-Sondas
Aspiration-Sondes
Aspirazione-Sonde



Universal

CFS-02-300-01

CFS-02-300-02

CFS-02-300-03

CFS-02-300-04

Fig. 1
 6.0 mmØ

Fig. 2
 4.5 mmØ

Fig. 3
 3.0 mmØ

Fig. 4
 1.75 mmØ

Set
 Satz
 Juego
 Jeu
 Serie



Uckermann
 CFS-02-301-13
 13 cm - 5"



Sinus

CFS-02-302-01

CFS-02-302-02

CFS-02-302-03

17 cm - 6 3/4"

3.5 mmØ

5.0 mmØ

5.0 mmØ



Lichtwitz

CFS-02-304-18

1.8 mmØ

CFS-02-304-20

2.0 mmØ

19 cm - 7 1/2"



Ochsner

CFS-02-305-10 3 1/2 mmØ 10 Char./Fr.

CFS-02-305-12 4 mmØ 12 Char./Fr.

CFS-02-305-14 4 3/4 mmØ 14 Char./Fr.

CFS-02-305-16 5 1/2 mmØ 16 Char./Fr.

CFS-02-305-18 6 mmØ 18 Char./Fr.

CFS-02-305-20 6 3/4 mmØ 20 Char./Fr.

CFS-02-305-22 7 1/2 mmØ 22 Char./Fr.

CFS-02-305-24 8 mmØ 24 Char./Fr.

CFS-02-305-26 8 3/4 mmØ 26 Char./Fr.

CFS-02-305-28 9 1/2 mmØ 28 Char./Fr.

10 cm - 4"



Nelson

CFS-02-306-60

6.0 mmØ

CFS-02-306-83

8.3 mmØ

CFS-02-306-95

9.5 mmØ

CFS-02-306-11

11.6 mmØ

21 cm - 8 1/4"







Cooley
Fig. 1

CFS-02-311-35 35 cm - 13 3/4"
8 mmØ



Fig. 2

CFS-02-312-31 31 cm - 12 1/4"
10 mmØ



Fig. 3

CFS-02-313-30 30 cm - 12"
6 mmØ



Fig. 4

CFS-02-314-33 33 cm - 13"
8 mmØ





Poole
CFS-02-315-22 22 cm - 8" 8 mmØ
 23 Charr./Fr.
 Curved



Poole
CFS-02-316-22 22 cm - 8" 10 mmØ
 30 Charr./Fr.
 Straight



Andrews-Pynchon
CFS-02-317-23 23.5 cm - 9 1/4"



De Bakey
CFS-02-318-27 27.5 cm - 10 3/4"



Lower Tip only
CFS-02-319-27
Yankauer
CFS-02-320-27 27 cm - 10 3/4"



Hartmann

CFS-02-321-01	CFS-02-321-04	2.0 mmØ
CFS-02-321-02	CFS-02-321-05	2.5 mmØ
CFS-02-321-03	CFS-02-321-06	3.0 mmØ

Fig. 1

Fig. 2



Killian

○	CFS-02-322-25	2.5 mmØ
●	CFS-02-322-30	3.0 mmØ

16 cm - 6"

oval opening
 ovale Öffnung
 apertura oval
 ouverture ovale
 apertura ovale



Hartmann

CFS-02-323-00	CFS-02-323-01	CFS-02-323-02	CFS-02-323-03	CFS-02-323-04	CFS-02-323-05	15 cm - 6"
---------------	---------------	---------------	---------------	---------------	---------------	------------

Fig. 0

Fig. 1

Fig. 2

Fig. 3

Fig. 4

Fig. 5





CFS-02-324-00

Tube end piece for eustachian catheter
 Schlaucholive für Ohrkatheter
 Olive para sondas auriculares
 Olive pour sonde auriculaire
 Olive per sonde auricolari

Trölsch

CFS-02-325-01

Fig. 1

CFS-02-325-02

Fig. 2

CFS-02-325-03

Fig. 3

CFS-02-325-04

Fig. 4

CFS-02-325-05

Fig. 5



Syringe

CFS-02-326-02 50 ccm

CFS-02-326-03 75 ccm

CFS-02-326-04 100 ccm

CFS-02-326-05 150 ccm

complete with 2 nozzles
 komplett mit 2 Aufsätzen
 completa con 2 canulas
 complet avec 2 canules
 completa con 2 terminali

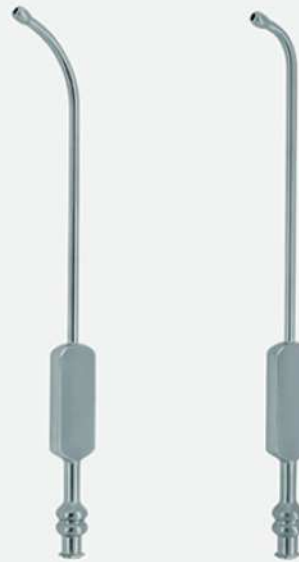

Eicken

CFS-02-327-01

CFS-02-327-02

slightly curved
 leicht gebogen
 ligeramente curvada
 légèrement courbé
 leggermente curva

CFS-02-327-03

CFS-02-327-04

2.5 mmØ

3.0 mmØ

strongly curved
 stark gebogen
 muy curvada
 très courbé
 fortemente curva



**Motershed
 Fig. 1**

CFS-02-328-03

3.0 mmØ
 Luer
 Lock



**Motershed
 Fig. 2**

CFS-02-329-02

2.5 mmØ
 Luer
 Lock



Fisch

CFS-02-330-04

4.0 mmØ





Strol
 Fig. 1
CFS-02-331-01

straight
 gerade
 recta
 droite
 retta

Tonsil needle
 Tonsillenanüle
 Aguja para amigdales
 Aiguille pour amygdales
 Cannule per tonsille



Fig. 2
CFS-02-331-02 0.8 mmØ

curved
 gebogen
 curva
 courbe
 curva



Fig. 3
CFS-02-332-01

bayonet
 bajonettförmig
 bayoneta
 baïonette
 baionetta

Septum needle
 Septumkanüle
 Aguja para el tabique nasal
 Aiguille pour le cloison nasal
 Ago per setto nasale

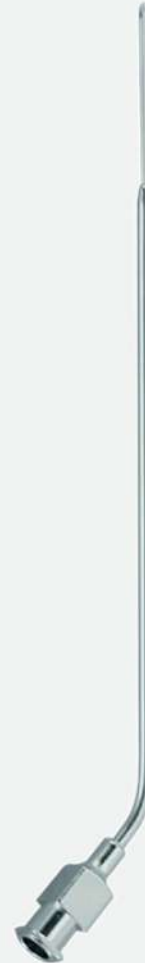
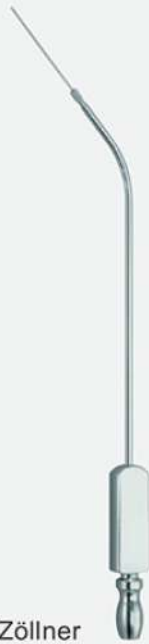

Fig. 4
CFS-02-332-02 0.8 mmØ

angled on flat
 abgewinkelt
 angulado
 coudé sur le plat
 angolato



Zöllner

CFS-02-333-07

0.7 mmØ

complete with 1 slip-on cannula, 0.7 mm Ø
 komplett mit 1 aufsetzbaren Kanüle, 0.7 mm Ø
 completo con 1 cánula desmontable de 0.7 mm Ø
 complet avec 1 canule démontable, 0.7 mm de Ø
 completa di 1 cannula applicabile di mm 0.7 di Ø



Iowa

CFS-02-334-16 0.7 mmØ

16 cm - 6 1/4"



Magill

CFS-02-335-30 3.0 mmØ

CFS-02-335-35 3.5 mmØ

CFS-02-335-40 4.0 mmØ

24.5 m - 9 3/4"

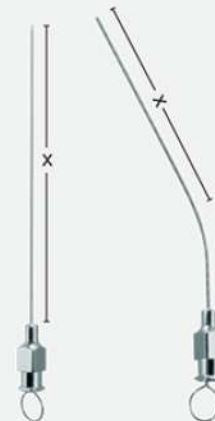

Rosen

CFS-02-336-07 CFS-02-337-07 0.7 mmØ

CFS-02-336-09 CFS-02-337-09 0.9 mmØ

CFS-02-336-12 CFS-02-337-12 1.2 mmØ

x = 80 mm

x = 65 mm



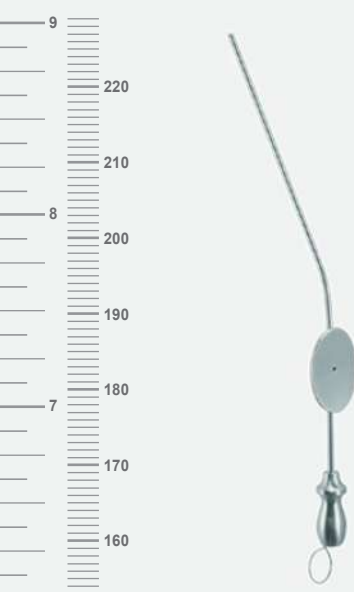

Baron

CFS-02-338-03	CFS-02-339-03	1 mmØ	3 Charr./Fr.
CFS-02-338-05	CFS-02-339-05	1 7/8 mmØ	5 Charr./Fr.
CFS-02-338-07	CFS-02-339-07	2 7/8 mmØ	7 Charr./Fr.
7.5 cm - 3"		10 cm - 4"	

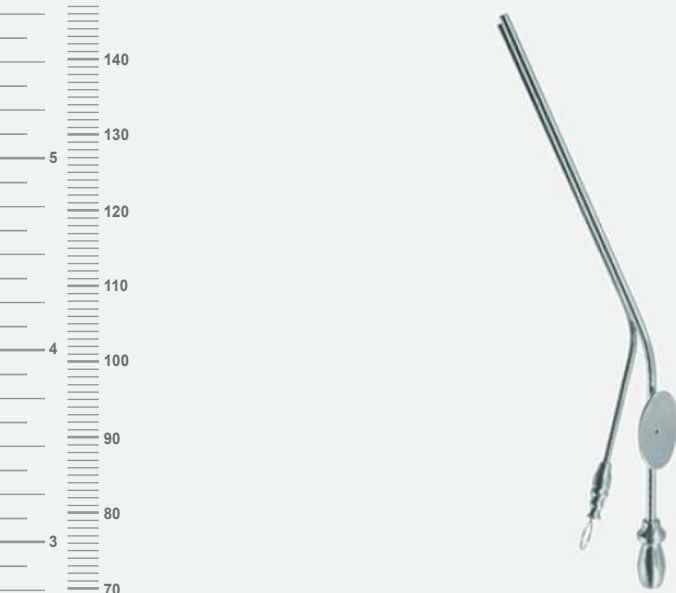

House

CFS-02-340-03	CFS-02-341-03	1 mmØ	3 Charr./Fr.
CFS-02-340-05	CFS-02-341-05	1 7/8 mmØ	5 Charr./Fr.
CFS-02-340-07	CFS-02-341-07	2 7/8 mmØ	7 Charr./Fr.
CFS-02-340-08	CFS-02-341-08	2 7/8 mmØ	8 Charr./Fr.
CFS-02-340-10	CFS-02-341-10	3 7/8 mmØ	10 Charr./Fr.
CFS-02-340-12	CFS-02-341-12	4 mmØ	12 Charr./Fr.
CFS-02-340-14	CFS-02-341-14	4 7/8 mmØ	14 Charr./Fr.
7.5 cm - 3"		10 cm - 4"	

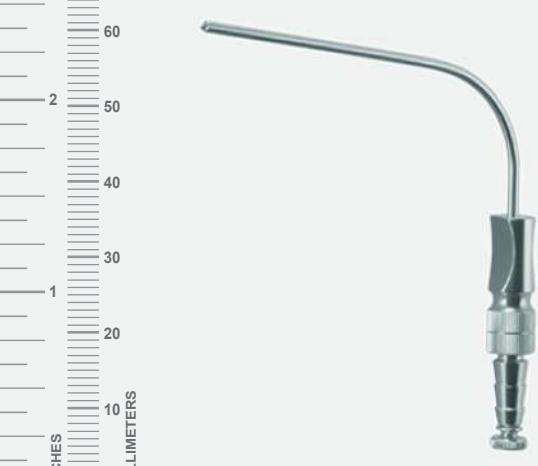

Fergusson

CFS-02-342-06	2 mmØ	6 Charr./Fr.
CFS-02-342-07	2 7/8 mmØ	7 Charr./Fr.
CFS-02-342-08	2 7/8 mmØ	8 Charr./Fr.
CFS-02-342-09	3 mmØ	9 Charr./Fr.
CFS-02-342-10	3 7/8 mmØ	10 Charr./Fr.
CFS-02-342-12	4 mmØ	12 Charr./Fr.
CFS-02-342-15	5 mmØ	15 Charr./Fr.

17 cm - 6 3/4"



Plester

CFS-02-343-06	2 mmØ	6 Charr./Fr.
CFS-02-343-07	2½ mmØ	7 Charr./Fr.
CFS-02-343-08	2½ mmØ	8 Charr./Fr.
CFS-02-343-09	3 mmØ	9 Charr./Fr.
CFS-02-343-10	3½ mmØ	10 Charr./Fr.
CFS-02-343-12	4 mmØ	12 Charr./Fr.
CFS-02-343-15	5 mmØ	15 Charr./Fr.

17 cm - 6 ¾"



Frazier

CFS-02-344-06	2 mmØ	6 Charr./Fr.
CFS-02-344-07	2½ mmØ	7 Charr./Fr.
CFS-02-344-08	2½ mmØ	8 Charr./Fr.
CFS-02-344-09	3 mmØ	9 Charr./Fr.
CFS-02-344-10	3½ mmØ	10 Charr./Fr.
CFS-02-344-12	4 mmØ	12 Charr./Fr.
CFS-02-344-15	5 mmØ	15 Charr./Fr.

17 cm - 6 ¾"



Adson

CFS-02-345-12	4 mmØ	12 Charr./Fr.
CFS-02-345-15	5 mmØ	15 Charr./Fr.

21 cm - 8 ¼"



Elena

CFS-02-346-20

20 cm - 8"

Suction raspatory – malleable, sharp
 Saug-Raspatorium – biegsam, scharf
 Legra aspiradora – maleable y agudo
 Rugine aspirante – flexible, tranchant
 Elevatore-aspiratore – flessibile, tagliente



Guide Needles

Redon Führungsnadeln

Agujas de Guia

Aiguilles d introduction

Aghi guida

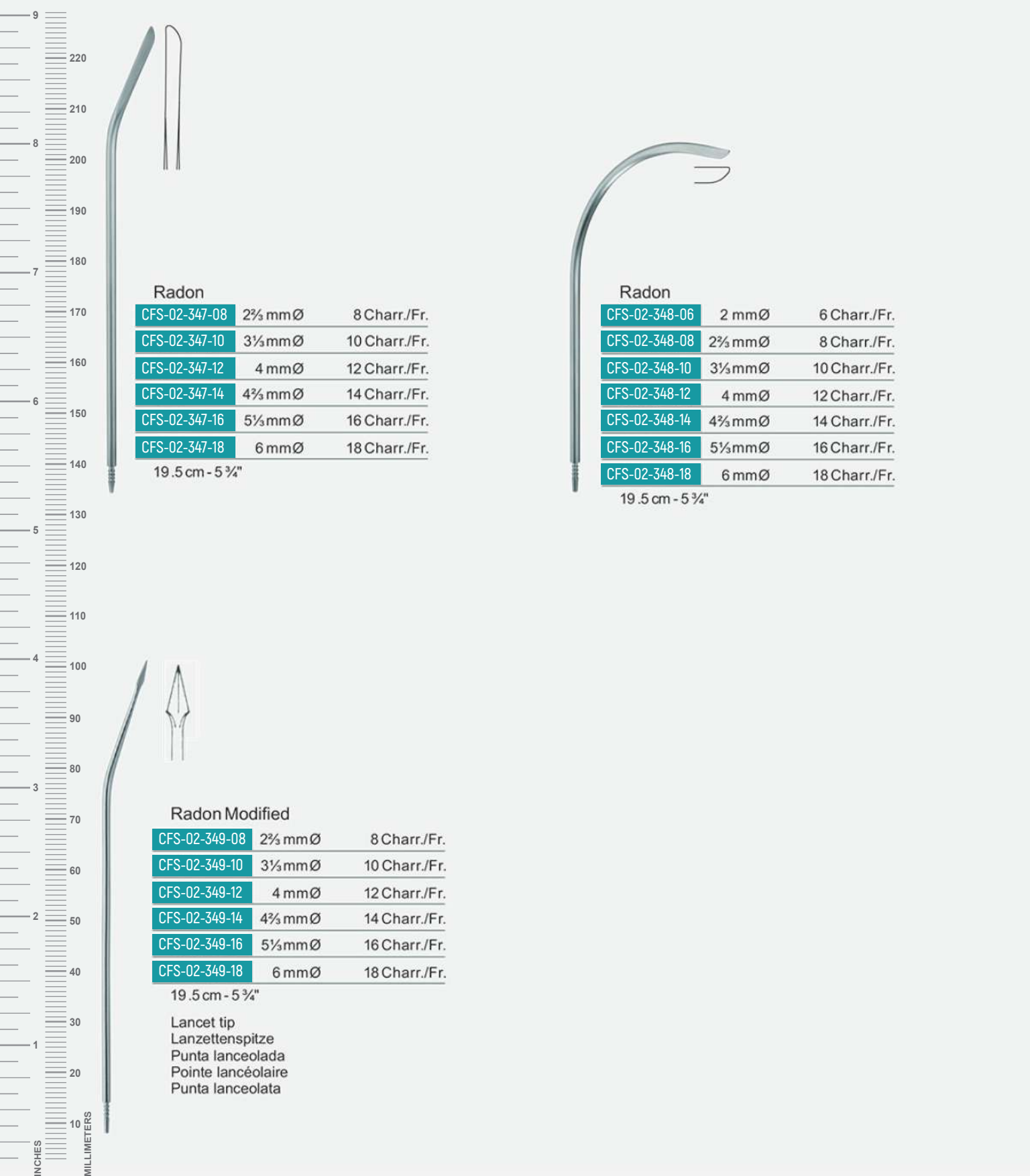

Radon

CFS-02-347-08	2½ mmØ	8 Charr./Fr.
CFS-02-347-10	3½ mmØ	10 Charr./Fr.
CFS-02-347-12	4 mmØ	12 Charr./Fr.
CFS-02-347-14	4½ mmØ	14 Charr./Fr.
CFS-02-347-16	5½ mmØ	16 Charr./Fr.
CFS-02-347-18	6 mmØ	18 Charr./Fr.

19.5 cm - 5 ¾"

Radon

CFS-02-348-06	2 mmØ	6 Charr./Fr.
CFS-02-348-08	2½ mmØ	8 Charr./Fr.
CFS-02-348-10	3½ mmØ	10 Charr./Fr.
CFS-02-348-12	4 mmØ	12 Charr./Fr.
CFS-02-348-14	4½ mmØ	14 Charr./Fr.
CFS-02-348-16	5½ mmØ	16 Charr./Fr.
CFS-02-348-18	6 mmØ	18 Charr./Fr.

19.5 cm - 5 ¾"

Radon Modified

CFS-02-349-08	2½ mmØ	8 Charr./Fr.
CFS-02-349-10	3½ mmØ	10 Charr./Fr.
CFS-02-349-12	4 mmØ	12 Charr./Fr.
CFS-02-349-14	4½ mmØ	14 Charr./Fr.
CFS-02-349-16	5½ mmØ	16 Charr./Fr.
CFS-02-349-18	6 mmØ	18 Charr./Fr.

19.5 cm - 5 ¾"

Lancet tip
Lanzettenspitze
Punta lanceolada
Pointe lanceolaire
Punta lanceolata



Pravaz (Luer-Lock)

CFS-02-350-01	Fig. 1	0.90 x 38 mm Ø
CFS-02-350-02	Fig. 2	0.80 x 32 mm Ø
CFS-02-350-12	Fig. 12	0.70 x 32 mm Ø
CFS-02-350-14	Fig. 14	0.65 x 28 mm Ø
CFS-02-350-16	Fig. 16	0.60 x 25 mm Ø
CFS-02-350-18	Fig. 18	0.50 x 23 mm Ø
CFS-02-350-20	Fig. 20	0.45 x 20 mm Ø



Package of 12 pieces
Packung à 12 Stück
Paquete de 12 piezas
Paquet de 12 pièces
Confezione da 12 pezzi





Quinke

CFS-02-351-04	1.20 x 76.0 mm Ø
CFS-02-351-02	1.20 x 89.0 mm Ø
CFS-02-351-03	1.00 x 76.0 mm Ø
CFS-02-351-04	1.00 x 89.0 mm Ø
CFS-02-351-05	0.70 x 76.0 mm Ø
CFS-02-351-06	0.70 x 50.0 mm Ø
CFS-02-351-07	0.70 x 89.0 mm Ø



Tuohy

CFS-02-352-01	1.20 x 76.0 mm Ø
CFS-02-352-02	1.40 x 76.0 mm Ø
CFS-02-352-03	1.60 x 76.0 mm Ø



Bier

CFS-02-353-01	1.20 x 80.0 mm Ø
CFS-02-353-02	1.20 x 90.0 mm Ø



Klima-Rosegger

CFS-02-354-00	1.80 x 35.0 mm Ø
---------------	------------------



Verres

CFS-02-355-01	2.00 x 100 mm Ø
CFS-02-355-02	2.00 x 120 mm Ø
CFS-02-355-03	2.00 x 150 mm Ø



Menghini

CFS-02-356-01	1.00 x 35.0 mm Ø
CFS-02-356-02	1.00 x 70.0 mm Ø
CFS-02-356-03	1.20 x 70.0 mm Ø
CFS-02-356-04	1.20 x 100.0 mm Ø
CFS-02-356-05	1.40 x 70.0 mm Ø
CFS-02-356-06	1.40 x 100.0 mm Ø
CFS-02-356-07	1.60 x 70.0 mm Ø
CFS-02-356-08	1.80 x 100.0 mm Ø



Menghini

CFS-02-357-01	1.40 x 168.0 mm Ø
CFS-02-357-02	1.80 x 168.0 mm Ø

Connecting pieces and stopcocks
 Verbindungsstücke und Hähne
 Piezas de conexión y llaves
 Raccords et robinets
 Raccordi e rubinetti



Connector
 Fig. 1

CFS-02-358-00



Fig. 2

CFS-02-359-00



Franklin-Silverman
 Mod. Fuchs

CFS-02-360-01	2.00 x 105.0 mm Ø	1.50 x 155.0 mm Ø
CFS-02-360-02	2.00 x 130.0 mm Ø	1.50 x 180.0 mm Ø

For kidney biopsy, incl. guide needle
 Zur perkutanen Nierenbiopsie, einschl. Suchnadel
 Para la biopsia de los riñones, con aguja de guía
 Pour la biopsie des reins, aiguille d'introduction incl.
 Per la biopsia renale, con ago guida

⊗ = Outer diameter
 Außendurchmesser
 Diametro esterno
 Diamètre externe
 Diametro esterno

⊙ = Inner diameter
 Innendurchmesser
 Diametro interno
 Diamètre interne
 Diametro interno



Franklin-Silverman

CFS-02-361-01	CFS-02-361-03	2.00 x 105.0 mm Ø	1.50 x 155.0 mm Ø
CFS-02-361-02	CFS-02-361-04	2.50 x 145.0 mm Ø	1.50 x 180.0 mm Ø

without barb ohne Widerhaken sin garfio sans crochet senza gancio	barbed mit Widerhaken con garfio avec crochet con gancio	For liver and kidney biopsy Zur Leber- und Nierenbiopsie Para la biopsia de los riñones y del hígado Pour la biopsie des reins et de la foie Per la biopsia renale ed epatica
---	--	---

CFS-02-362-01	CFS-02-362-03	2.00 x 100.0 mm Ø	1.50 x 150.0 mm Ø
CFS-02-362-02	CFS-02-362-04	2.50 x 145.0 mm Ø	1.50 x 195.0 mm Ø

Biopsy needle, only
 Kanüle, allein
 Aguja para biopsia, sola
 Aiguille pour biopsie, seul
 Ago per biopsia, solo





Luer

CFS-02-363-01	CFS-02-364-01	1 ml
CFS-02-363-02	CFS-02-364-02	2 ml
CFS-02-363-05	CFS-02-364-05	5 ml
CFS-02-363-10	CFS-02-364-10	10 ml
CFS-02-363-20	CFS-02-364-20	20 ml
CFS-02-363-50	CFS-02-364-50	50 ml

Syringe, complete Barrel
 Spritze, komplett Zylinder
 Jeringa, completa Cilindro
 Seringue, complète Cylindre
 Siringa, completa Cilindro



Luer-Lock

CFS-02-365-01	CFS-02-366-01	1 ml
CFS-02-365-02	CFS-02-366-02	2 ml
CFS-02-365-05	CFS-02-366-05	5 ml
CFS-02-365-10	CFS-02-366-10	10 ml
CFS-02-365-20	CFS-02-366-20	20 ml
CFS-02-365-50	CFS-02-366-50	50 ml

Syringe, complete Barrel
 Spritze, komplett Zylinder
 Jeringa, completa Cilindro
 Seringue, complète Cylindre
 Siringa, completa Cilindro



Luer-Lock

CFS-02-367-01	CFS-02-368-01	1 ml
CFS-02-367-02	CFS-02-368-02	2 ml
CFS-02-367-05	02-368-05	5 ml

Syringe, complete Barrel
 Spritze, komplett Zylinder
 Jeringa, completa Cilindro
 Seringue, complète Cylindre
 Siringa, completa Cilindro

CFS-02-369-00

Luer Lock attachment
 Luer Lock Anschluß
 Conector Luer Lock
 Raccord Luer Lock
 Raccordo Luer Lock



Janet

CFS-02-370-50	CFS-02-371-50	50 ml
CFS-02-370-75	CFS-02-371-75	75 ml
CFS-02-370-100	CFS-02-371-100	100 ml
CFS-02-370-150	CFS-02-371-150	150 ml
CFS-02-370-200	CFS-02-371-200	200 ml

Syringe, complete Barrel
 Spritze, komplett Zylinder
 Jeringa, completa Cilindro
 Seringue, complète Cylindre
 Siringa, completa Cilindro



Probe

CFS-02-372-11	CFS-02-373-11	CFS-02-374-11	11.5 cm - 4 1/2"
CFS-02-372-13	CFS-02-373-13	CFS-02-374-13	13 cm - 5"
CFS-02-372-14	CFS-02-373-14	CFS-02-374-14	14.5 cm - 5 3/4"
CFS-02-372-16	CFS-02-373-16	CFS-02-374-16	16 cm - 6 1/4"
CFS-02-372-18	CFS-02-373-18	CFS-02-374-18	18 cm - 7"
CFS-02-372-20	CFS-02-373-20	CFS-02-374-20	20 cm - 8"
CFS-02-372-25	CFS-02-373-25	CFS-02-374-25	25 cm - 9 3/4"
2.0 mmØ	1.5 mmØ	1.0 mmØ	



Probe with Eye

CFS-02-375-11	11.5 cm - 4 1/2"
CFS-02-375-13	13 cm - 5"
CFS-02-375-14	14.5 cm - 5 3/4"
CFS-02-375-16	16 cm - 6 1/4"
CFS-02-375-18	18 cm - 7"
CFS-02-375-20	20 cm - 8"
CFS-02-375-25	25 cm - 9 3/4"

2 mmØ
with eyelet
mit Ohr
con ojo
avec oeil
con cruna



Concave

CFS-02-376-11	11.5 cm - 4 1/2"
CFS-02-376-13	13 cm - 5"
CFS-02-376-14	14.5 cm - 5 3/4"
CFS-02-376-16	16 cm - 6 1/4"

2 mmØ
myrtle-shaped
Myrtenblattsonde
en forme de mirto
en forme de myrte
forma di mirto



Butterfly
Fig. 1

CFS-02-377-11	11.5 cm - 4 1/2"
CFS-02-377-13	13 cm - 5"
CFS-02-377-14	14.5 cm - 5 3/4"
CFS-02-377-16	16 cm - 6 1/4"
CFS-02-377-18	18 cm - 7"
CFS-02-377-20	20 cm - 8"



Butterfly
Fig. 2

CFS-02-378-11	11.5 cm - 4 1/2"
CFS-02-378-13	13 cm - 5"
CFS-02-378-14	14.5 cm - 5 3/4"
CFS-02-378-16	16 cm - 6 1/4"
CFS-02-378-18	18 cm - 7"
CFS-02-378-20	20 cm - 8"

With pointed end



Doyen

CFS-02-379-14	14 cm - 5 1/2"
---------------	----------------



Nelaton

CFS-02-380-16	16 cm - 6 1/2"
---------------	----------------



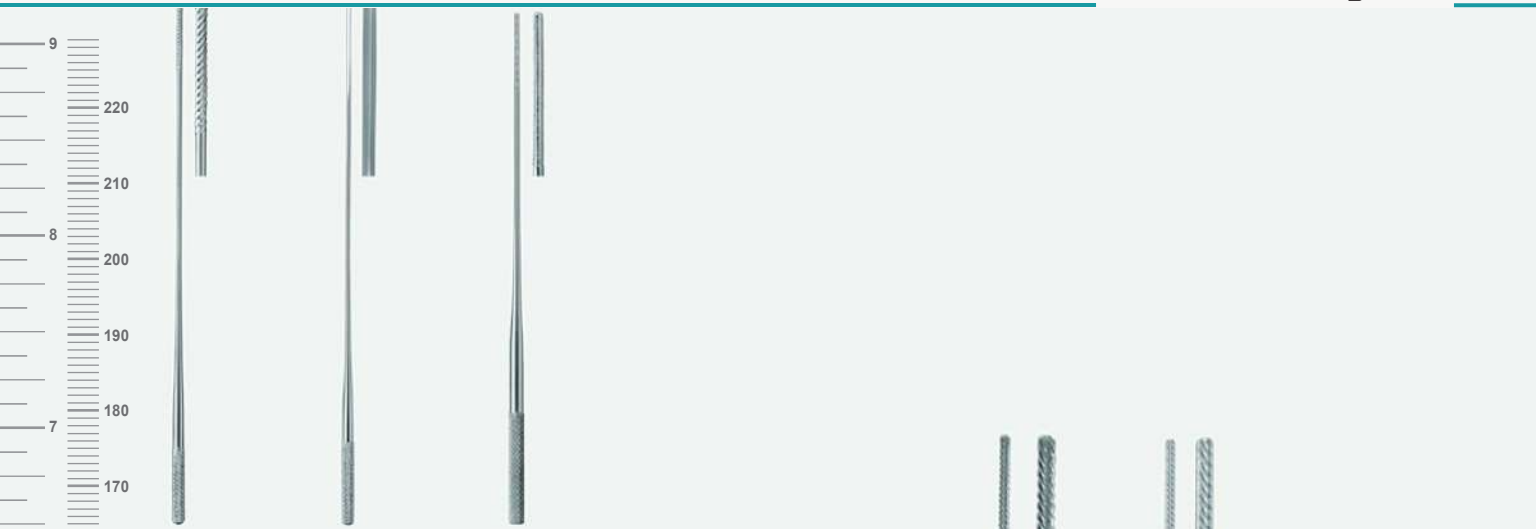

160 Farrell-Lathbury

CFS-02-381-12	CFS-02-382-12	CFS-02-383-12	12 cm - 4 3/4"	0.9 mm Ø
CFS-02-381-14	CFS-02-382-14	CFS-02-383-14	14 cm - 5 1/2"	0.9 mm Ø
CFS-02-381-16	CFS-02-382-16	CFS-02-383-16	16.5 cm - 6 1/4"	1.1 mm Ø
CFS-02-381-18	CFS-02-382-18	CFS-02-383-18	18 cm - 7"	1.2 mm Ø
CFS-02-381-23	CFS-02-382-23	CFS-02-383-23	23 cm - 9"	1.3 mm Ø

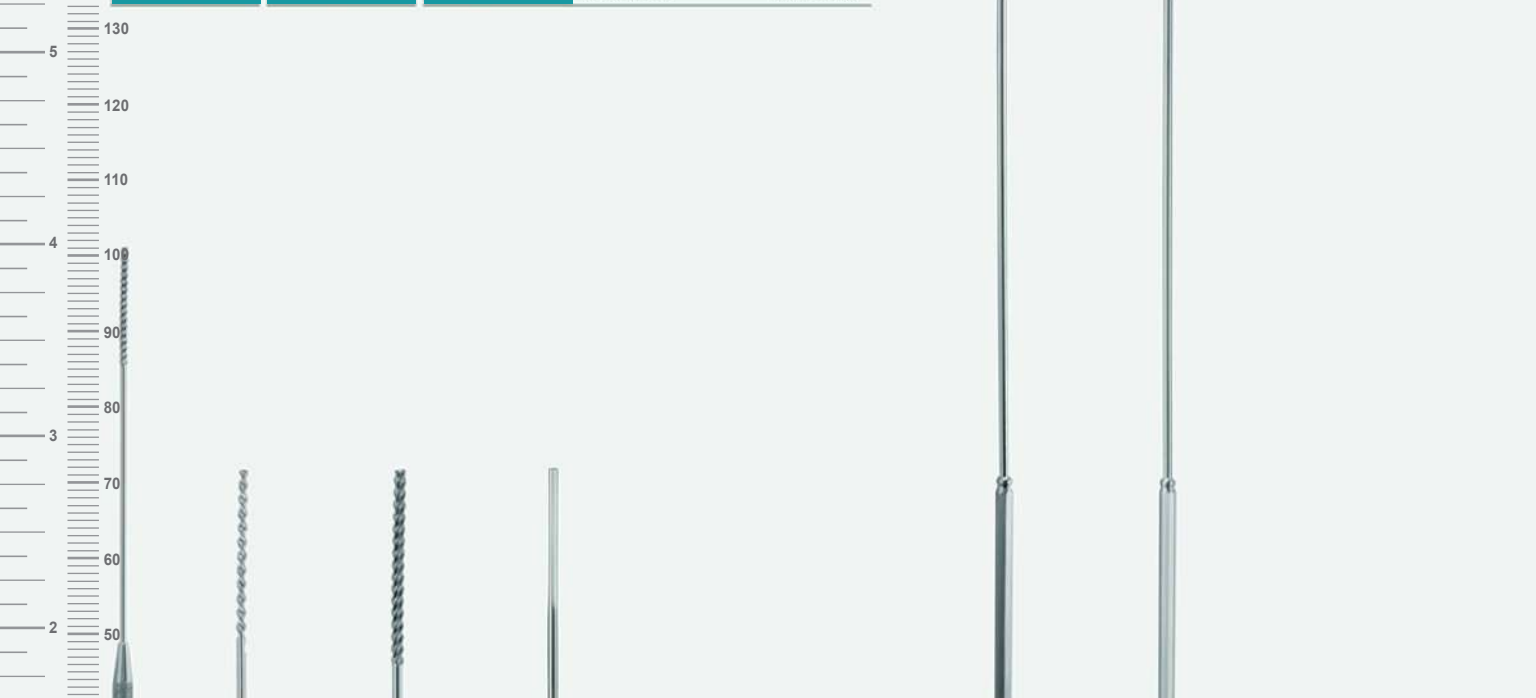

Mod. Martin

CFS-02-384-12	CFS-02-385-12	CFS-02-386-12	12 cm - 4 3/4"
CFS-02-384-14	CFS-02-385-14	CFS-02-386-14	14 cm - 5 1/2"
CFS-02-384-16	CFS-02-385-16	CFS-02-386-16	16.5 cm - 6 1/4"
CFS-02-384-18	CFS-02-385-18	CFS-02-386-18	18 cm - 7"

1.2 mm Ø

1.5 mm Ø

1.5 mm Ø

Saleh

CFS-02-387-28	CFS-02-388-28	28 cm - 11"
2.5 mm Ø	2.5 mm Ø	

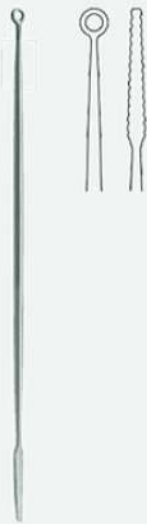

Jopson-Horne

Fig. 2

CFS-02-389-14 14 cm - 5½"

CFS-02-389-18 18 cm - 7"



Fein

CFS-02-390-28

28 cm - 11"

